

**Accessori / 40**

*Accessories / Accessoires / Accessoires*

**Accessori Appoggio / 152**

*Tabletop accessories / Accessoires à poser / Accessoires zum Stand*

**Scopini / 166**

*Toilet brush holders / Porte-balais / Wc Bürste*

**Piantane / 180**

*Accessory and towel stands / Ensembles d'accessoires sur pied ou muraux / Ständer*

**Mobili / 198**

*Furniture / Meubles / Möbel*

**Colonne / 224**

*Cabinets / Colonnes / Spalten*

**Pensili / 236**

*Cabinets / Armoires / Schrank*

**Basi su ruote / 240**

*Drawer units on castors / Meubles sur roulettes / Schränke auf Rollen*

**Lavabi / 248**

*Washbasins / Lavabos / Waschbecken*

**Specchi / 276**

*Mirrors / Mirrors / Spiegel*

**Lampade / 298**

*Lamps / Lampes / Lampen*

**Termoarredi / 310**

*Radiators / Radiateurs / Heizkörper*

**Complementi / 324**

*Complements / Compléments / Ergänzungen*

**Doccia / 338**

*Shower / Douche / Dusche*

**Contract / 382**

*Contract / Hôtellerie / Hotel*

**Sifoni e Pilette / 394**

*Siphons, water drains / Siphons, bondes / Siphons, Ablaufgarnituren*

**Rubinetteria / 403**

*Taps and fittings / Robinetterie / Armaturen*

29



*Gentile Cliente*

Il nuovo catalogo Lineabeta 29 nasce sotto i migliori auspici.

Lo storico marchio, nato nel 1980 per la produzione di accessori colorati, giovani e innovativi entra oggi a far parte di una grande squadra, Samo Industries, la capogruppo della mia famiglia, che detiene la proprietà di diversi marchi storici nel mondo dell'arredo bagno.

Samo Industries nasce, infatti, nel 2013 con la missione di esprimere eccellenza in molti aspetti del mondo bagno che implicino design, tecnologia e innovazione, valori che ho riscontrato in Lineabeta.

Lineabeta oggi guarda in particolare al marchio Samo, leader Europeo per la tecnologia e il design della cabina doccia per completarne il catalogo attraverso l'ampiezza della propria gamma, oggi rinnovata, di accessori, complementi e mobili per un bagno che esprima appieno l'abitare contemporaneo.

Denis Venturato  
presidente

*Dear Customer,*

*The new Lineabeta Product Catalogue #29 comes to life under the most propitious circumstances.*

*The iconic brand established in 1980 which produces trendy, innovative and colorful bath accessories is now part of a bigger organization: Samo Industries. Samo Industries, the Holding Company of my family, already owns other historical brands from the bathroom decor industry.*

*As a matter of fact, Samo Industries was constituted in 2013 with the mission to bring excellence in many areas of the bathroom industry like design, technology and innovation: the same mission-statement that I found in Lineabeta.*

*Lineabeta now looks up mostly to Samo -the European leading manufacturer of shower boxes when it comes to design and technology- for enriching its own Catalogue while expanding the product range (now renovated) of bathroom hardware, accessories and furniture which totally embrace the soul of the contemporary lifestyle.*

*Cher Client,*

*Le nouveau catalogue Lineabeta 29 naît sous les meilleurs auspices.*

*La marque historique - née en 1980 pour la production d'accessoires colorés, jeunes et innovants - fait désormais partie d'une grande équipe, Samo Industries, la holding de ma famille, qui détient la propriété de plusieurs marques historiques dans l'univers de la Salle de bains.*

*Samo Industries est née en effet en 2013, avec la mission d'exprimer l'excellence dans de nombreux aspects du monde de la Salle de bains, impliquant design, technologie et innovation, valeurs que j'ai retrouvées dans Lineabeta.*

*Lineabeta vient compléter aujourd'hui le catalogue de la marque Samo - leader en Europe pour sa technologie et son design dans le domaine de la paroi de douche - avec sa large gamme renouvelée d'accessoires, de compléments et de meubles pour une salle de bains qui reflète pleinement le style des habitations contemporaines.*

*Sehr geehrter Kunde,*

*der neue Katalog Lineabeta 29 wurde unter der besten Schirmherrschaft geboren.*

*Die historische Marke - geboren in 1980 für die Produktion von farbigen, jungen und innovativen Accessoires - ist heute Teil eines großartigen Teams, Samo Industries, der Muttergesellschaft meiner Familie, die mehrere historische Marken in der Bad-Möbelwelt besitzt.*

*Samo Industries wurde im Jahr 2013 mit dem Ziel geboren, in vielen Aspekten der Badwelt hervorragende Leistungen zu erbringen, einschließlich Design, Technologie und Innovation, Werte, die ich in Lineabeta gefunden habe.*

*Die Firma Lineabeta möchte heute insbesondere mit der Marke Samo - europäischer Marktführer für Duschtrennungstechnologie und -Design- ihren Katalog durch die jetzt erneuerte Auswahl an Accessoires, Einrichtungszubehör, Möbeln für ein zeitgemäßes Badezimmer zu vervollständigen.*

n.29



# INDEX

## 6\_FINITURE

*Finishing / Finitions / Finishes*

## 40\_ACCESSORI

*Accessories / Accessoires / Accessoires*

### 42\_Sbekà **NEW**

### 48\_Dado **NEW**

### 56\_Grela

### 62\_Saeta

### 68\_Baketo

### 78\_Roersa

### 84\_Curvà

### 90\_Icselle

### 96\_Skuara

### 106\_Duemila

### 116\_Picola

### 124\_Napie

### 132\_Venessia

### 140\_Inamorà **NEW**

## 152\_ACCESSORI APPOGGIO

*Tabletop accessories / Accessoires à poser / Accessoires zum Stand*

## 166\_SCOPINI

*Toilet brush holders / Porte-balais / Wc Bürste*

### Scopini a pavimento

*Floor toilet brush holders / Porte-balais à poser / WC-Bürstengarnitur am Boden*

### Scopini a parete

*Wall toilet brush holders / Porte-balais muraux / WC-Bürstengarnitur Wandmodell*

## 180\_PIANTANE

*Accessory and towel stands / Ensembles d'accessoires sur pied ou muraux / Ständer*

### Piantane a parete

*Wall ladders / Porte-serviettes muraux / Ständer am Wand*

### Piantane a pavimento

*Floor accessory and towel stands / Ensembles d'accessoires sur pied / Ständer am Boden*

## 198\_MOBILI E CONTENITORI

*Cabinets and furniture / Armoires et meubles / Schränke*

### Mobili componibili **NEW**

*Modular furniture / Meubles à éléments modulaires / Modulare Möbel*

### Piani top per lavabi **NEW**

*Tops for tabletop washbasins / Plans pour vasques à poser / Platte zum Waschbecken*

### Supporti per lavabo

*Wash-table units / Meubles pour lavabo / Halter zum Waschtisch*

### 224\_Colonne **NEW**

*Cabinets / Colonnes / Spalten*

### 236\_Pensili **NEW**

*Cabinets / Armoires / Schrank*

### 240\_Basi su ruote **NEW**

*Drawer units on castors / Meubles sur roulettes / Schränke auf Rollen*

## 248\_LAVABI

*Washbasins / Lavabos / Waschbecken*

### 250\_Lavabi da appoggio

*Countertop washbasins / Vasques à poser / Aufsatzbecken*

### 262\_Lavabi a parete

*Wall washbasins / Lavabos à accrocher au mur / Wand Becken*

### 268\_Freestanding **NEW**

*Pedestal washbasins / Lavabos colonne / Pedestal Waschbecken*

# INDEX

## **272\_** Lavabi ad incasso /

*Built-in washbasins / Lavabos encastrés / Einbauwaschbecken*

## **276\_** SPECCHI E LAMPADE

*Mirrors and lamps / Miroirs et lampes / Spiegel und Lampen*

## **286\_** Specchi con luce **NEW**

*Mirrors with lighting / Miroirs avec lumière / Spiegel mit licht*

## **290\_** Specchi ingranditori

*Magnifying mirrors / Miroirs grossissants / Wand-Vergrößerungsspiegel*

## **298\_** Lampade **NEW**

*Lamps / Lampes / Lampen*

## **310\_** TERMOARREDI

*Radiators / Radiateurs / Heizkörper*

## **314\_** Termoarredi elettrici

*Electric radiators / Radiateurs électriques / Heizkörper elektrischer*

## **316\_** Termoarredi ad acqua

*Hydraulic radiators / Radiateurs hydrauliques / Heizkörper mit Wasser*

## **324\_** COMPLEMENTI

*Complements / Compléments / Ergänzungen*

## **326\_** Cestini

*Paper baskets / Corbeilles à papier / Papierkorb*

## **330\_** Portabiancheria

*Laundry baskets / Paniers à linge / Wäschekorb*

## **334\_** Sgabelli **NEW**

*Stools / Tabourets / Hocker*

## **338\_** DOCCIA

*Shower / Douche / Dusche*

## **340\_** Doccia da esterni

*Outdoor shower / Douche pour usage externe / Aussendusche beweglich*

## **344\_** Soffioni e bracci doccia /

*Shower heads and shower-arms / Pommes de douche et bras de douche / Kopfbrause und Brausearm*

## **358\_** Colonne doccia e doccette

*Shower columns and hand shower / Colonnes de douche et douchettes / Duschsäulen und Handbrause*

## **366\_** Griglie e accessori doccia **NEW**

*Shower baskets and shower accessories / Paniers et accessoires de douche / Duschkörbe und Duschzubehöre*

## **374\_** Pedane

*Shower mats / Caillebotis / Duschfußbrette*

## **382\_** CONTRACT

*Contract / Contract / Hôtellerie / Hotel*

## **394\_** SIFONI, PILETTE E RUBINETTERIA

*Siphons, water drains, taps and fittings / Siphons, bondes et robinetterie / Siphons, Ablaufgarnituren und Armaturen*

## **396\_** Sifoni

*Siphons / Siphons / Siphons*

## **398\_** Pilette

*Water drains / Bondes / Ablaufgarnituren*

## **401\_** Prese acqua

*Water outlet / Sorties d'eau / Wandanschlussbogen*

## **403\_** Rubinetteria

*Taps and fittings / Robinetterie / Armaturen*

## **408\_** Condizioni generali di trasporto e vendita

## **410\_** General transport and sale terms

## **412\_** Conditions générales de vente et de transport

## **414\_** Allgemeine Verkaufs und Geschäftsbedingungen

# NEW

## NUOVE COLLEZIONI

*New collections / Nouvelles collections / Neuheit Kollektionen*

### ACCESSORI

*Accessories / Accessoires / Accessoires*

**SBECA** pag. 42

**DADO** pag. 48

**INAMORA** pag. 140

### PIANTANE

*Stands / Ensembles d'accessoires sur pied / Wc Kombination und Handtuchständer*

**STELA** pag. 184 - 185

### MOBILI

*Furniture / Meubles / Schränke*

**GRELA** pag. 204 - 205 - 206 - 207 - 208 - 209 - 210 - 211 - 212 - 213

### PIANI TOP PER LAVABI

*Tops for tabletop washbasins / Plans pour vasques à poser / Platte zum Waschbecken*

**DE SORA** pag. 214 - 215

### COLONNE E PENSILI

*Cabinets / Armoires / Schrank*

**GRELA** pag. 232 - 233 - 234 - 235 - 236 - 237

### BASI SU RUOTE

*Drawer units on castors / Meubles sur roulettes / Schränke auf Rollen*

**CARETO** pag. 245

### LAVABI FREESTANDING

*Pedestal washbasins / Lavabos colonne / Pedestal Waschbecken*

**CADIN** pag. 271

### SPECCHI

*Mirrors / Miroirs / Spiegel*

**SPECI** pag. 285 - 286 - 288 - 289

### LAMPADE

*Lamps / Lampes / Lampen*

**CIARI** pag. 301 - 302

### SGABELLI

*Stools / Tabourets / Hocker*

**GRELA** pag. 334

### GRIGLIE

*Shower baskets / Paniers de douche / Duschkörbe*

**FILO** pag. 372 - 373

### PILETTE

*Water drains / Bondes / Ablaufgarnituren*

**BUSI E CANE** pag. 399

# LEGENDA

Legend / Legende / Légende



**Novità**  
New  
Nouveauté  
Neuheit



**Made in Italy**  
Made in Italy  
Made in Italy  
Made in Italy



**Made in Europe**  
Made in Europe  
Made in Europe  
Made in Europe

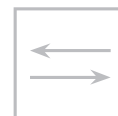

**Reversibile**  
Reversible  
Réversible  
Umkehrbar



**Fissaggio a muro**  
Wall mounting with screws  
Fixation murale par vis  
Wandbefestigung mit Schraube



**Incollo a muro**  
Wall adhesive  
Fixation murale avec colle  
Wand Kleber



**Acciaio 304**  
Steel 304  
Acier 304  
Stahl 304



**Acciaio 316**  
Steel 316  
Acier 316  
Stahl 316



**Touch**  
Touch  
Touch  
Touch



**Articolo con led**  
Article with leds  
Article avec led  
électroluminescentes  
Artikel mit LED



**Led freddo**  
Led cold  
Led froide  
Led kalt



**Led caldo**  
Led warm  
Led chaude  
Warme Led



**Ad Acqua**  
Water  
Eau  
Wasser

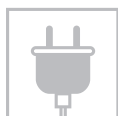

**Elettrico**  
Electric  
Électrique  
Elektrisch



**Design essenziale**  
Essential design  
Design essentiel  
Schlichtes Design



**Saldatura laser**  
Laser welding  
Soudure laser  
Laserschweißen



**Alta efficienza energetica**  
High energy efficiency  
Haute économie d'énergie  
Hohe Energieeffizienz



**Facile da installare**  
Easy to install  
Facile à installer  
Einfach zu installieren



**Facile da pulire**  
Easy to clean  
Facile à nettoyer  
Einfach zu säubern



**Uso versatile**  
Versatile placing  
Utilisation polyvalente  
Vielseitig Platzierung



**Portasalviette**  
Towel holder included  
Porte-serviettes inclus  
Handtuchhalter enthalten



**Ingranditore 3X**  
Magnifying 3X  
Grossissant 3X  
Vergrößerungsspiegel 3X



**Ingranditore 5X**  
Magnifying 5X  
Grossissant 5X  
Vergrößerungsspiegel 5X



**Ingranditore 8X**  
Magnifying 8X  
Grossissant 8X  
Vergrößerungsspiegel 8X

# Finiture / *Finishing / Finitions / Ausführung*

## Laminato / *Laminated / Stratifié / Holzlaminat*



**.01** *\_Olmo bianco / White elm tree / Orme blanc / Weiße Ulme*



**.02** *\_Olmo fumè / Smoke elm tree / Orme fumé / Rauch Ulme*

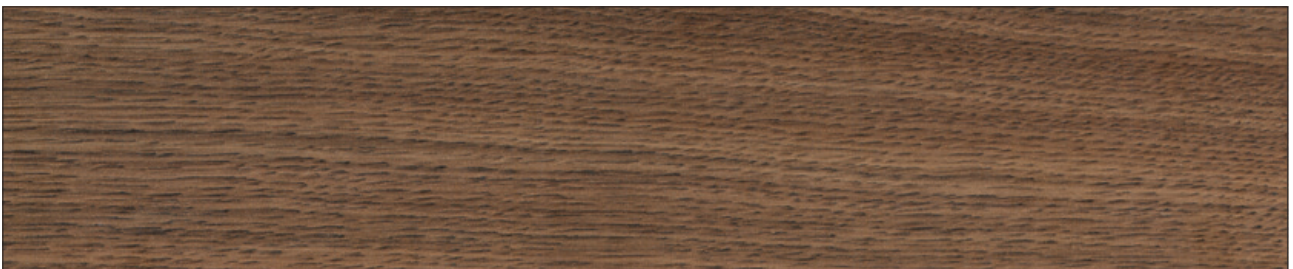

**.03** *\_Rovere castano / Brown Oak / Chêne brun / Braune Eiche*



**.05** *\_Rovere naturale / Natural Oak / Chêne naturel / Natürliche Eiche*

## Legno / *Wood / Bois / Holz*



**.03** *\_Bambù naturale / Natural bamboo / Bambou naturel / Natürlicher Bambus*



# Finiture / *Finishing / Finitions / Ausführung*

## Laccato lucido / *Glossy lacquered / Laqué brillant / Glänzend Lackiert*



**.09L\_Bianco** / *White / Blanc / Weiss*



**.17L\_Antracite** / *Anthracite / Anthracite / Anthrazit*



**.21L\_Tortora** / *Dove grey / Gris tourterelle / Taubengrau*



**.22L\_Nero** / *Black / Noir / Schwarz*

## Laccato opaco / *Matt lacquered / Laqué mat / Matt Lackiert*

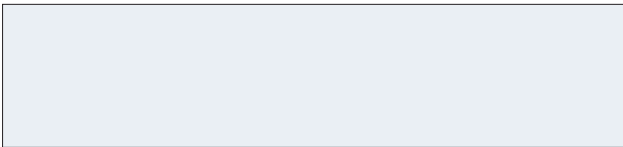

**.09\_Bianco** / *White / Blanc / Weiss*

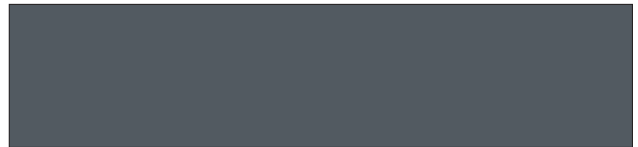

**.17\_Antracite** / *Anthracite / Anthracite / Anthrazit*



**.21\_Tortora** / *Dove grey / Gris tourterelle / Taubengrau*

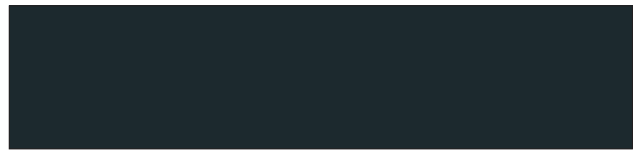

**.22\_Nero** / *Black / Noir / Schwarz*

## Mineralmarmo / *Mineral marble / Minéral marbre / Mineralguss*



**.09\_Bianco lucido** / *Glossy white / Blanc brillant / Weiß glänzend*

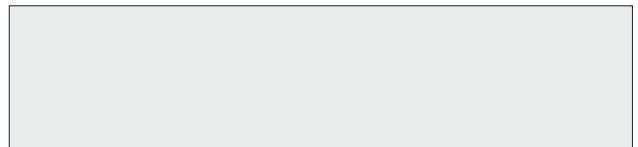

**.26\_Bianco opaco** / *Matt white / Blanc mat / Weiß matt*

## Solid Surface / *Solid Surface / Solid Surface / Solid Surface*



**.09\_Bianco lucido** / *Glossy white / Blanc brillant / Weiß glänzend*

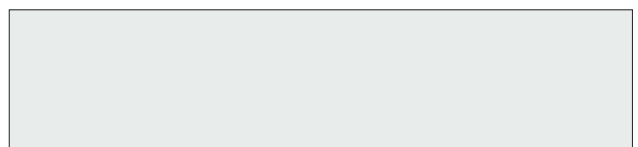

**.26\_Bianco opaco** / *Matt white / Blanc mat / Weiß matt*

# Finiture / *Finishing / Finitions / Ausführung*

## Metallo / *Metal / Métal / Metall*



**.09\_Bianco gofrato** / *Goffering white*  
*Blanc gaufré / Geprägtes Weiß*



**.17\_Antracite gofrato** / *Goffering anthracite*  
*Anthracite gaufré / Geprägtes Anthrazit*



**.18\_Nero gofrato** / *Goffering black*  
*Noir gaufré / Geprägtes Schwarz*



**.22\_Nero liscio** / *Smooth black*  
*Noir lisse / Glatt Schwarz*

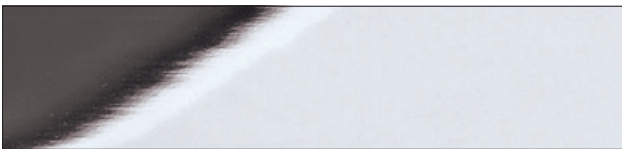

**.29\_Metallo cromo** / *Chromed metal*  
*Métal chromé / Chrom Metall*

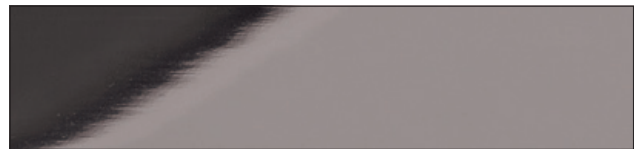

**.33\_Metallo nichel nero** / *Black nickel colored metal*  
*Métal couleur nickel noir / Schwarz Nickel Metall*

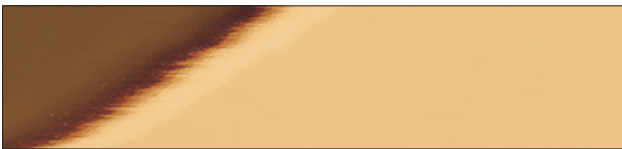

**.30\_Metallo oro** / *Gold colored metal*  
*Métal couleur or / Gold Metall*

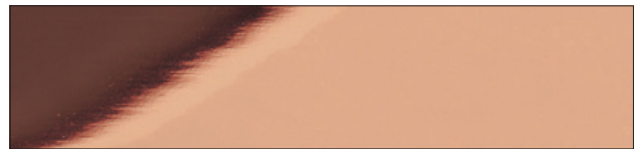

**.35\_Metallo bronzo** / *Bronze metal*  
*Métal couleur bronze / Bronze Metall*



**.32\_Metallo satinato** / *Satinated metal*  
*Métal satiné / Vereist Metall*

# Finiture / *Finishing / Finitions / Ausführung*

## Ceramica / *Ceramic / Céramique / Keramik*



**.09\_Bianca lucida** / *Glossy white*  
*Blanc brillant / Weiß glänzend*



**.17\_Antracite opaca** / *Matt anthracite*  
*Anthracite mat / Anthrazit matt*

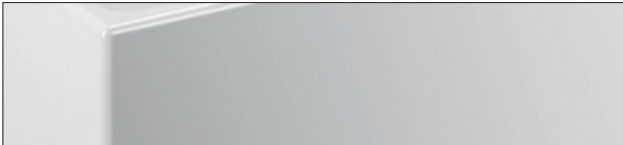

**.26\_Bianca opaca** / *Matt white*  
*Blanc mat / Weiß matt*

## Vetro / *Glass / Verre / Glas*



**.80\_Trasparente** / *Transparent*  
*Transparent / Klarglas*

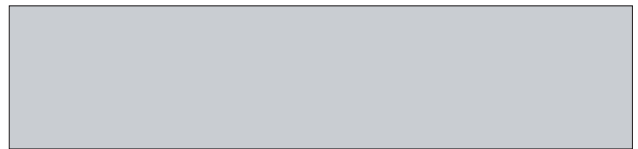

**.81\_Vetro acidato** / *Etched glass*  
*Verre dépoli / Geätztes Glas*

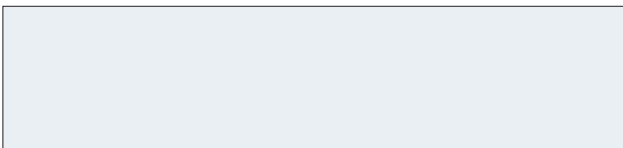

**.82\_Trasparente extrachiaro** / *Extraclear transparent*  
*Transparent extra clair / Klarglas Extra klar*

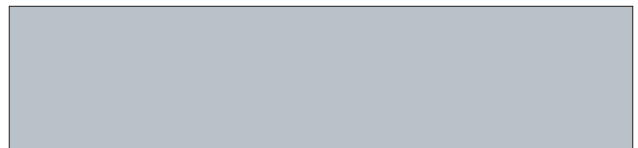

**.84\_Vetro satinato** / *Brushed glass*  
*Verre satiné / Glas geätzt*

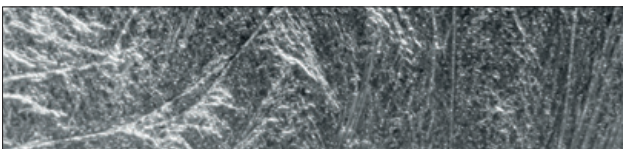

**.29\_Vetro foglia argento** / *Silver leaf glass*  
*Feuille couleur argent / Blattsilber Glas*



**.30\_Vetro foglia oro** / *Gold leaf glass*  
*Feuille couleur or / Gold Blatt Glas*

# 40 anni di design italiano

40 years of Italian design / 40 ans de design italien / 40 Jahre italienisches Design

**IT /** Lineabeta è il marchio del lusso accessibile, bello e dinamico nel mondo del bagno. Lineabeta interpreta il quotidiano di chi desidera progettare e arredare il bagno con un tocco di freschezza, funzionalità, semplicità, ironia.

Sogniamo per tutti un bagno confortevole, allestito con prodotti funzionali all'uso, facili da tenere puliti, destinati a durare nel tempo e dall'estetica sempre contemporanea, accessibili ai più.

Come recita il payoff "everyday design" aspiriamo a un ambiente da vivere quotidianamente in modo semplice e spontaneo.

La forte identità dei nostri prodotti è legata ai nomi scelti per le nostre collezioni. Nomi mai scelti a caso, coerenti con la forma o la funzione cui devono assolvere, strettamente legati al territorio perché espressi nella nostra lingua, il Veneto.

Rendiamo disponibili i nostri prodotti tramite canali di vendita preferenziali quali boutique specializzate nell'arredo bagno, i punti vendita dell'idrotermosanitario, il retail mobili e il contract.

**EN /** Lineabeta is the accessible, beautiful and dynamic luxury brand for bathrooms. Lineabeta exemplifies the daily life of those who want to design and furnish the bathroom with a fresh, functional, simple and ironic touch.

Our dream is to give everybody a comfortable bathroom, equipped with functional items, which is easy to keep clean and designed to last over time, characterized by a contemporary aesthetics and accessible to most people.

As the "everyday design" tag line explains, we aim to obtain an environment that can be used every day simply and effortlessly.

The strong identity of our products is linked to the names chosen for our collections. The names were not chosen at random as they are consistent with the form they have or the function they must perform, and are closely connected to the territory because they are expressed in our language, the Venetian dialect.

We sell our products through preferential sales channels such as boutiques specializing in bathroom furnishings, points of sale in the plumbing and heating sector, as well as in the furniture retail and contract sectors.

**FR /** Lineabeta est la marque du Luxe accessible, esthétique et dynamique dans le monde de la salle de bains. Lineabeta interprète la vie quotidienne de ceux qui souhaitent concevoir et équiper leur salle de bains d'une touche de fraîcheur, de fonctionnalité, de simplicité, d'esprit.

Nous rêvons tous d'une salle de bains confortable, équipée de produits fonctionnels, faciles à entretenir, destinés à durer dans le temps, et à l'esthétique toujours plus contemporaine, accessible à tous.

Comme le dit notre slogan "everyday design", nous aspirons à un environnement pour vivre au quotidien de manière simple et spontanée.

La forte identité de nos produits est liée aux noms choisis pour nos collections. Des noms jamais choisis au hasard, cohérents avec la forme ou la fonction qu'ils doivent assumer, et étroitement liés au territoire car ils sont déclinés dans notre langue, le vénitien.

Nos produits sont disponibles au travers de canaux de vente préférentiels tels que boutiques spécialisées dans l'aménagement de salle de bains, points de vente dédiés au sanitaire, magasins de meubles et le contract.

**DE /** Lineabeta ist der Markenname für erschwinglichen, schönen und dynamischen Luxus im Bad. Lineabeta interpretiert den Alltag dessen, der das Bad mit der gewissen Frische, Funktionalität, Einfachheit und Ironie planen und einrichten möchte.

Wir erträumen uns für alle ein komfortables Bad, ausgestattet mit bedienungs- und reinigungsfreundlichen Produkten, die für eine lange Lebensdauer ausgelegt sind, eine Optik besitzen, die stets zeitgemäß ist und die für die meisten von uns erschwänglich sind.

Wie der Slogan "everyday design" erahnen lässt, erstreben wir ein Ambiente, das täglich einfach und spontan erlebt werden kann.

Die starke Persönlichkeit unserer Produkte ist mit den Namen verbunden, die wir für unsere Kollektionen gewählt haben. Namen, die niemals Zufall sind, Namen, die die Form oder die zu erfüllende Aufgabe beinhalten und eng mit der hiesigen Gegend verbunden sind, weil sie in unserer Sprache ausgedrückt werden, dem Veneto-Dialekt.

Wir bieten unsere Produkte über Vorzugskanäle an, etwa über auf Badeinrichtungen spezialisierte Boutiquen, über Verkaufsstellen für Heizungs- und Sanitäreinrichtungen, über den Möbeleinzelhandel und über Anbieter ganzheitlicher Ausstattungskonzepte.



# Mission

Offriamo a molti l'opportunità di vivere un prodotto nato da persone che lavorano con creatività pensando alle esigenze di tutti.

We offer the opportunity to experience a product designed by people who put their creativity at the service of everybody's needs.

Nous offrons l'opportunité à beaucoup de découvrir un produit pensé par des personnes qui travaillent avec créativité en prenant en compte des exigences de tous.

Wir bieten Vielen die Möglichkeit, ein Produkt zu erleben, das von Personen stammt, die kreativ arbeiten und dabei die Bedürfnisse aller im Auge behalten.

# I nostri valori

our values / nos valeurs / unsere werte

## **Passione**

passion / passion / Leidenschaft

## **Coraggio**

courage / courage / Mut

## **Collaborazione**

teamworking / collaboration / Zusammenarbeit

## **Rispetto**

respect / respect / Respekt

## **Integrità**

integrity / intégrité / Integrität



**home** | contract | outdoor





**IT /** Pensiamo al bagno come l'ambiente che più di tutti avvalora e qualifica una casa. Un luogo intimo, privato e prezioso: il vero spazio dedicato al sé. Realizziamo soluzioni di design capaci di influenzare gli stili di vita delle persone grazie a prodotti nati dalla creatività italiana.

**FR /** Nous pensons la salle de bains comme la pièce qui, comme aucune autre, valorise et caractérise une maison. Un lieu intime, personnel et précieux : le véritable espace dédié à soi. Nous créons des solutions de design capables d'influencer les styles de vie de chacun grâce à des produits issus de la créativité italienne.

**EN /** For us, the bathroom is the room that represents and qualifies a home more than any other. It is an intimate, private and precious room: a really personal place. We develop design solutions capable of influencing people's lifestyles thanks to products originating from Italian creativity.

**DE /** Wir sehen das Bad als Ambiente, das mehr als alle anderen ein Haus ausmacht und ihm Wert verleiht. Ein intimer, ein privater, ein kostbarer Ort: der eigentliche Raum, den man sich selbst widmet. Wir realisieren Designlösungen, die es vermögen, den Lebensstil der Menschen mit Produkten zu beeinflussen, die der italienischen Kreativität entspringen.



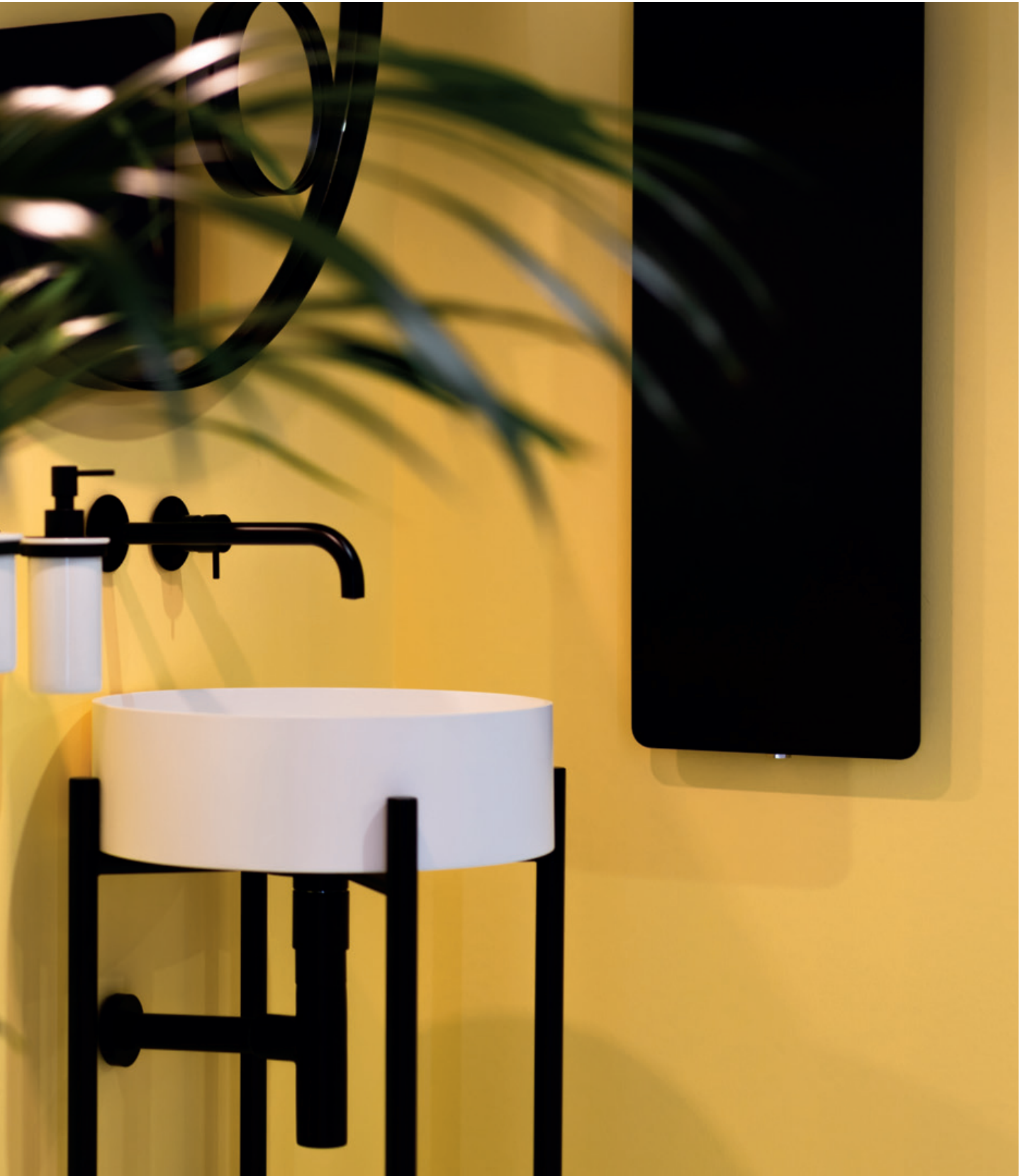

home | **contract** | outdoor







**IT /** Pubblico e privato, per noi di Lineabeta sono la stessa cosa: il bagno deve essere pratico, funzionale e accessibile da chiunque in qualunque momento. Deve rispondere alle esigenze di tutti, offrendo sempre altissimi standard di igiene, qualità e sicurezza.

**EN /** For us at Lineabeta, the public sector is no different from the private one: the bathroom must be practical, functional, and accessible to anyone at any time. It must meet everyone's needs, always offering the highest standards of hygiene, quality and safety.

**FR /** Public ou privé, pour nous Lineabeta, c'est pareil : la salle de bains doit être pratique, fonctionnelle et accessible à tous et à tout moment. Elle doit répondre aux attentes de chacun, garantissant toujours les plus élevés standards d'hygiène, de qualité et de sécurité.

**DE /** Öffentlich und privat - für uns von Lineabeta dasselbe: das Bad muss praktisch, funktionell und jederzeit für jeden zugänglich sein. Es muss den Bedürfnissen aller entsprechen und bei Hygiene, Qualität und Sicherheit stets höchste Standards bieten.

home | contract | **outdoor**





**IT /**

L'arredamento outdoor ricrea lo stesso comfort dell'interno nel proprio spazio verde.

L'istà è la doccia che provvede alla frescura tanto cercata nelle afose giornate estive, per poi essere riposta durante l'inverno.

**EN /** Outdoor furniture dedicated to our green spaces recreates the same comfort that can be found indoors. Istà is the shower that provides the much sought-after coolness in the sultry summer days, which can be stored away during the winter.

**FR /** Le mobilier outdoor a vocation de recréer à l'extérieur le même confort qu'à l'intérieur. Istà est la douche qui apporte la fraîcheur tant recherchée les jours d'été les plus chauds, pour être ensuite rangée pendant l'hiver.

**DE /** Die Einrichtung im Außenbereich schafft im eigenen grünen Eckchen denselben Komfort, wie im Innenbereich. Istà ist die Dusche, die für jene kühle Frische sorgt, die man sich an schwülen Sommertagen so herbeisehnt. Für den Winter wird sie dann hereingeholt.





S - M - L





# S - M - L

## **Small:**

il design accessibile  
*the accessible design*  
*le design accessible*  
*erschwingliches Design*

## **Medium:**

il design necessario  
*the necessary design*  
*le design essentiel*  
*notwendiges Design*

## **Large:**

il design che ti accompagna per tutta la vita  
*the design that accompanies you throughout your life*  
*le design qui vous accompagne tout au long de votre vie*  
*Design, das Sie Ihr Leben lang begleitet*

## COMPOSIZIONI S, M e L.

La suddivisione del budget per prodotti o famiglie di prodotti nasce dall'esigenza di dare la possibilità ai nostri clienti di costruire un'offerta personalizzata.

Lineabeta ha definito tre range economici (low, medium, high) ai quali associare tre distinti budget: S, M, L.

### **S, M, L COMPOSITIONS**

*The subdivision of the budget for products or families of products resulted from the need to give our customers the opportunity to build a personalized offer.*

*Lineabeta has defined three economic groups (low, medium, high) to which three distinct budgets are associated: S, M, L*

### **COMPOSITIONS S, M, L**

*La classement des gammes de prix par produits ou familles de produits résulte de la nécessité de donner à nos clients la possibilité de bénéficier d'une offre personnalisée.*

*Lineabeta a défini trois classifications (low, medium, high) auxquelles associer trois gammes de prix distinctes : S, M, L.*

### **ZUSAMMENSTELLUNGEN S, M, L**

*Mit der Unterteilung des Budgets nach Produkten oder Produktfamilien soll unseren Kunden die Möglichkeit gegeben werden, sich ein individuelles Angebot zusammenzustellen.*

*Lineabeta hat drei Preissegmente definiert (low, medium, high) denen drei verschiedene Budgets zugeordnet sind: S, M, L.*

# Small

## Contemporary

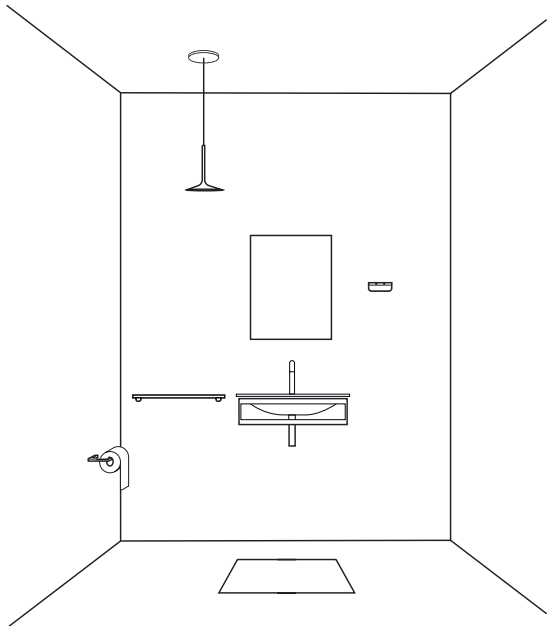

**Specchio / Mirrors / Miroirs / Spiegel**  
Speci

**Accessorio / Accessories / Accessoires / Accessoires**  
Curvà

**Lavabo / Washbasins / Lavabos / Waschbecken**  
Pocia

**Colonna / Column / Colonne / Hochschränken**  
Pikà

**Lampade / Lamps / Lampes / Lampen**  
Ciari







# Small

## Essential

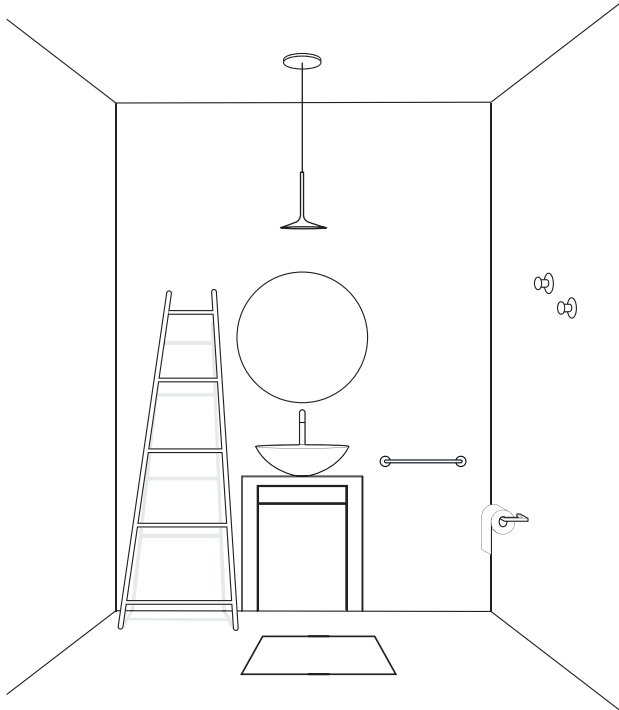

**Specchio / Mirrors / Miroirs / Spiegel**  
Speci

**Accessorio / Accessories / Accessoires / Accessoires**  
Duemila

**Lavabo / Washbasins / Lavabos / Waschbecken**  
Acquaio

**Mobile / Furniture / Meubles / Möbel**  
Canavera

**Piantana / Towel stands**  
Ensembles d'accessoires sur pied ou muraux / Ständer  
Posà

**Lampade / Lamps / Lampes / Lampen**  
Ciari





# Medium

## Contemporary

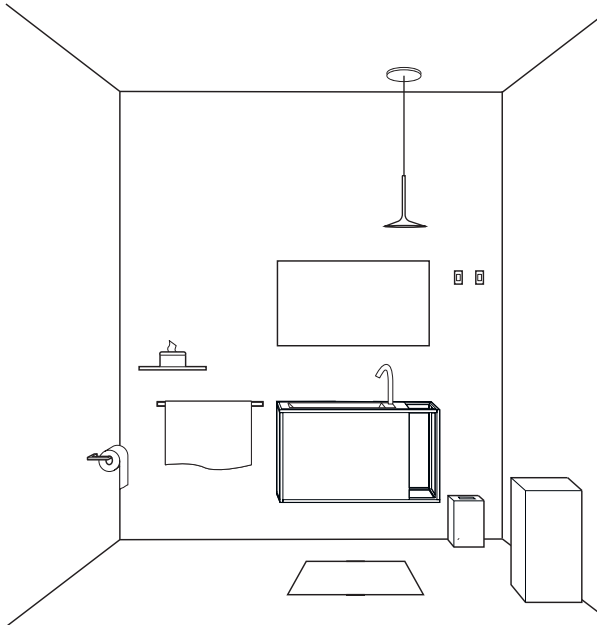

**Specchio / Mirrors / Miroirs / Spiegel**  
Speci

**Accessorio / Accessories / Accessoires / Zubehöre**  
Skuara

**Lavabo / Washbasins / Lavabos / Waschbecken**  
Grela

**Mobile / Furniture / Meubles / Möbel**  
Grela

**Complementi / Complements / Compléments / Ergänzungen**  
Bandoni

**Lampade / Lamps / Lampes / Lampen**  
Ciari





# Medium

## Essential

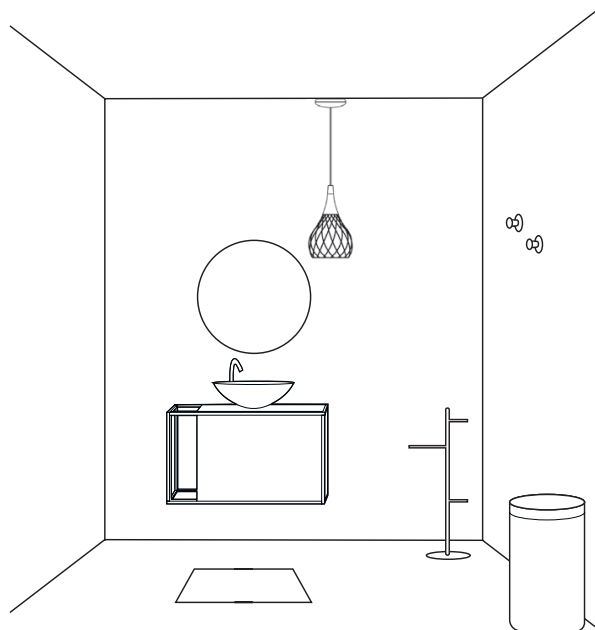

**Specchio / Mirrors / Miroirs / Spiegel**  
Speci

**Accessorio / Accessories / Accessoires / Zubehör**  
Napie

**Lavabo / Washbasins / Lavabos / Waschbecken**  
Acquaio

**Mobile / Furniture / Meubles / Möbel**  
Grela

**Complementi / Complements / Compléments / Ergänzungen**  
Sestei

**Piantana / Towel stands**  
Ensembles d'accessoires sur pied / Ständer  
Ranpin

**Lampade / Lamps / Lampes / Lampen**  
Ciari





# Large

## Must have

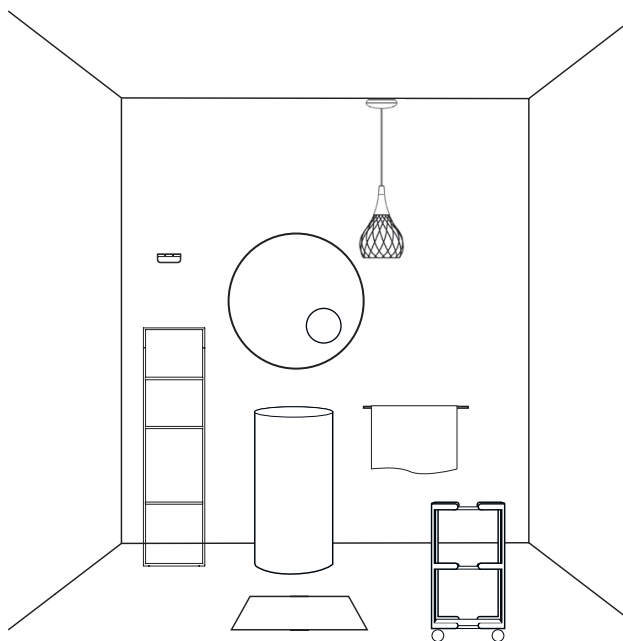

**Specchio** / Mirrors / Miroirs / Spiegel  
Speci

**Accessorio** / Accessories / Accessoires / Zubehöre  
Roersa

**Lavabo** / Washbasins / Lavabos / Waschbecken  
Momon

**Mobile** / Furniture / Meubles / Möbel  
Careto

**Piantana** / Towel stands  
Ensembles d'accessoires sur pied ou muraux / Ständer  
Grela

**Lampade** / Lamps / Lampes / Lampen  
Ciari

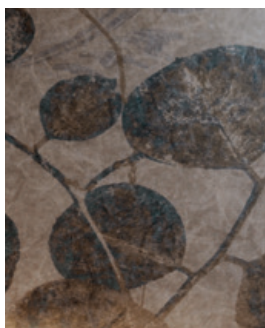





# accessori

*Accessories / Accessoires / Accessoires*

Sbecà / **42 NEW**

*Sbecà / Sbecà / Sbecà*

Dado / **48 NEW**

*Dado / Dado / Dado*

Grela / **56**

*Grela / Grela / Grela*

Saeta / **62**

*Saeta / Saeta / Saeta*

Baketo / **68**

*Baketo / Baketo / Baketo*

Roersa / **78**

*Roersa / Roersa / Roersa*

Curvà / **84**

*Curvà / Curvà / Curvà*

Icselle / **90**

*Icselle / Icselle / Icselle*

Skuara / **96**

*Skuara / Skuara / Skuara*

Duemila / **106**

*Duemila / Duemila / Duemila*

Piccola / **116**

*Piccola / Piccola / Piccola*

Napie / **124**

*Napie / Napie / Napie*

Venessia / **132**

*Venessia / Venessia / Venessia*

Inamorà / **140 NEW**

*Inamorà / Inamorà / Inamorà*





## Sbecà

### Accessori

Accessories / Accessoires / Accessoires

#### IT

##### **Sbecà:**

dal dialetto veneto significa sbeccato, oggetto che presenta una o più scheggiature.

È la nuova collezione di accessori disponibile in cromo e nero opaco, contraddistinta da un incavo angolare che la rende facilmente riconoscibile ed esclusiva.

Ottone cromato o verniciato nero opaco

Fissaggio con viti a muro o a incollo

#### EN

##### **Sbecà:**

*in Venetian dialect it means chipped; it indicates an object that has one or more chips.*

*It is the new accessory collection available in chrome and matt black, characterized by an angular recess that makes it easily recognizable and exclusive.*

*Chromed or matt black painted brass*

*Screwed or glued to the wall*

#### FR

##### **Sbecà :**

*du dialecte vénitien qui signifie ébréché, un objet qui présente un ou plusieurs impacts.*

*Il s'agit de la nouvelle collection d'accessoires disponible en chromé et en noir mat, caractérisée par un renfoncement dans l'angle qui la rend facilement reconnaissable et exclusive.*

*Laiton chromé ou verni noir mat*

*Fixation au mur avec vis ou avec colle*

#### DE

##### **Sbecà:**

*im venetischen Dialekt ein Gegenstand, der eine oder mehrere Absplitterungen aufweist.*

*Die neue Zubehörkollektion ist in Chrom und matt schwarz erhältlich und zeichnet sich durch eine eckige Aussparung aus, die für Wiedererkennungswert und Exklusivität sorgt.*

*Verchromtes oder matt schwarz lackiertes Messing*

*Wandbefestigung durch Anschrauben oder Kleben*

**Sbecà**

**Portarotolo**

Toilet paper holder / Porte-rouleau / Toilettenpapierhalter

**61104.nn**

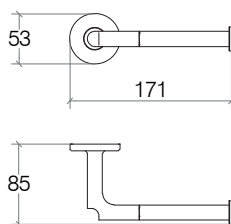

**Ottone cromato**  
Chromed brass  
Laiton chromé  
Verchromtes Messing

**Ottone verniciato**  
Painted brass  
Laiton laqué  
Lackiertem Messing



.29



.22



€ 35,00 - M

**Portarotolo coperto**

Toilet paper holder with lid / Porte-rouleau avec couvercle / Toilettenpapierhalter mit Deckel

**61105.nn**

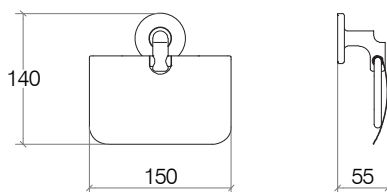

**Ottone cromato**  
Chromed brass  
Laiton chromé  
Verchromtes Messing

**Ottone verniciato**  
Painted brass  
Laiton laqué  
Lackiertem Messing



.29



.22



€ 57,00 - M

**Coppia appendini**

2 Hooks / Jeu de 2 patères / Paar Hacken

**61107.nn**

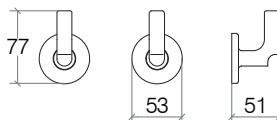

**Ottone cromato**  
Chromed brass  
Laiton chromé  
Verchromtes Messing

**Ottone verniciato**  
Painted brass  
Laiton laqué  
Lackiertem Messing



.29



.22



€ 46,00 - M

**Anello portasalviette**

Towel ring / Anneau porte-serviettes / Handtuchring

**61115.nn**

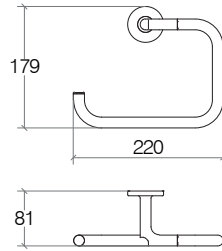

**Ottone cromato**  
Chromed brass  
Laiton chromé  
Verchromtes Messing

**Ottone verniciato**  
Painted brass  
Laiton laqué  
Lackiertem Messing



€ 56,00 - M

**Portasalviette 350 mm**

Towel rail 350 mm / Porte-serviettes 350 mm / Handtuchhalter 350 mm

**61108.nn**

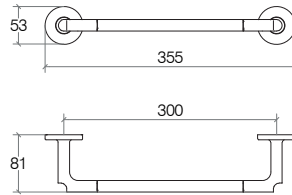

**Ottone cromato**  
Chromed brass  
Laiton chromé  
Verchromtes Messing

**Ottone verniciato**  
Painted brass  
Laiton laqué  
Lackiertem Messing

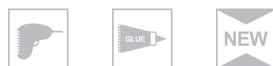

€ 49,00 - M

**Portasalviette 500 mm**

Towel rail 500 mm / Porte-serviettes 500 mm / Handtuchhalter 500 mm

**61109.nn**

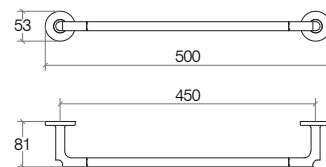

**Ottone cromato**  
Chromed brass  
Laiton chromé  
Verchromtes Messing

**Ottone verniciato**  
Painted brass  
Laiton laqué  
Lackiertem Messing



€ 55,00 - M

**Sbecà**

**Portasalviette 650 mm**

Towel rail 600 mm / Porte-serviettes 600 mm / Handtuchhalter 600 mm

**61110.nn**

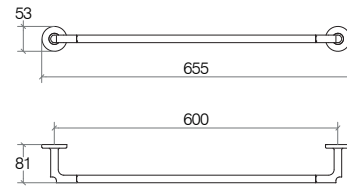

**Ottone cromato**

Chromed brass  
Laiton chromé  
Verchromtes Messing

**Ottone verniciato**

Painted brass  
Laiton laqué  
Lackiertem Messing



.29



.22



€ 59,00 - M

**Portasalviette 850 mm**

Towel rail 850 mm / Porte-serviettes 850 mm / Handtuchhalter 850 mm

**61111.nn**

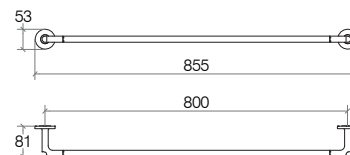

**Ottone cromato**

Chromed brass  
Laiton chromé  
Verchromtes Messing

**Ottone verniciato**

Painted brass  
Laiton laqué  
Lackiertem Messing



.29



.22



€ 65,00 - M



**Portabicchiere con bicchiere**

Holder with tumbler / Support avec verre / Halter mit Becher

**61101.nn.nn**

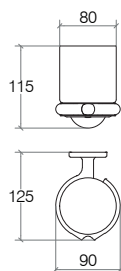

**Vetro acidato**  
Etched glass  
Verre dépoli  
Geätztes Glas

**Ottone cromato**  
Chromed brass  
Laiton chromé  
Verchromtes Messing

**Ottone verniciato**  
Painted brass  
Laiton laqué  
Lackiertem Messing



**.29.81**



**.22.81**



€ 49,00 - M

**Portasapone con piattino**

Holder with soap dish / Support avec porte-savon / Halter mit Seifenschale

**61102.nn.nn**

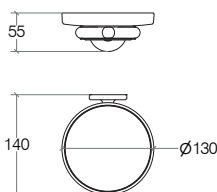

**Vetro acidato**  
Etched glass  
Verre dépoli  
Geätztes Glas

**Ottone cromato**  
Chromed brass  
Laiton chromé  
Verchromtes Messing

**Ottone verniciato**  
Painted brass  
Laiton laqué  
Lackiertem Messing



**.29.81**



**.22.81**



€ 49,00 - M

**Portasapone con dosasapone 250 ml**

Holder with soap dispenser 250 ml / Support avec distributeur savon liquide 250 ml / Halter mit Seifenspender 250 ml

**61103.nn.nn**

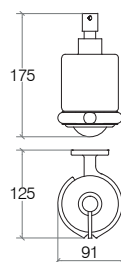

**Vetro acidato**  
Etched glass  
Verre dépoli  
Geätztes Glas

**Ottone cromato**  
Chromed brass  
Laiton chromé  
Verchromtes Messing

**Ottone verniciato**  
Painted brass  
Laiton laqué  
Lackiertem Messing



**.29.81**



**.22.81**



€ 63,00 - M



ESSENCE  
MISTED  
PATCHOULI  
UNDEVELOPED

## Dado

### Accessori

Accessories / Accessoires / Accessoires

#### IT

##### Dado:

oggetto dalla forma quadrata usato in molti giochi da tavolo.

Nuova collezione di accessori dal design geometrico e minimale, frutto di linee rigorose e angoli squadrati, in grado di caratterizzare l'ambiente bagno.

Ottone cromato

Fissaggio con viti a muro

#### EN

##### Dado:

square shaped object used in many board games.

A new collection of accessories with a geometric and minimal design, which consists of rigorous lines and squared corners able to give a distinct character to the bathroom.

Chromed brass

Screwed to the wall

#### FR

##### Dado :

c'est le dé, utilisé dans de nombreux jeux de société.

Nouvelle collection d'accessoires aux lignes carrées et au style moderne et minimaliste. Un impact visuel fort, une beauté discrète mais que l'on perçoit au premier coup d'œil.

Laiton chromé

Fixation au mur avec vis

#### DE

##### Dado:

zu Deutsch "Würfel", ein quadratisch geformtes Objekt also, das bei vielen Gesellschaftsspielen Verwendung findet.

Neue Zubehörsammlung mit einem geometrischen Minimaldesign aus strengen Linien und kantigen Ecken, das dem Bad ihren Stempel aufdrückt.

Verchromtes Messing

Wandbefestigung mit Schrauben

**Dado**

**Portarotolo**

Toilet paper holder / Porte-rouleau / Toilettenpapierhalter

**61204.29**

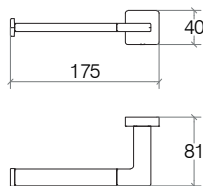

**Ottone cromato**  
Chromed brass  
Laiton chromé  
Verchromtes Messing



.29



€ 42,00 - M

**Portarotolo con riserva**

Toilet paper holder with reserve / Porte-rouleau réserve / Toilettenpapier Ersatzrollenhalter

**61206.29**

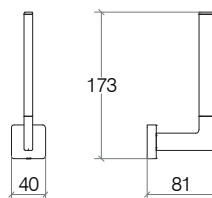

**Ottone cromato**  
Chromed brass  
Laiton chromé  
Verchromtes Messing



.29



€ 40,00 - M

**Portarotolo coperto**

Toilet paper holder with lid / Porte-rouleau avec couvercle / Toilettenpapierhalter mit Deckel

**61205.29**

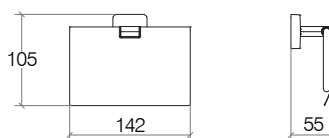

**Ottone cromato**  
Chromed brass  
Laiton chromé  
Verchromtes Messing



.29



€ 57,00 - M

**Coppia appendini**

2 Hooks / Jeu de 2 patères / Paar Hacken

**61207.29**

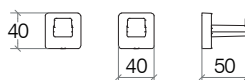

**Ottone cromato**  
Chromed brass  
Laiton chromé  
Verchromtes Messing



.29



€ 40,00 - M

**Portasalvietta 340 mm**

Towel rail 340 mm / Porte-serviettes 340 mm / Handtuchhalter 340 mm

**61208.29**

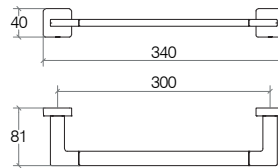

**Ottone cromato**  
Chromed brass  
Laiton chromé  
Verchromtes Messing



.29



€ 60,00 - M

**Portasalvietta 490 mm**

Towel rail 490 mm / Porte-serviettes 490 mm / Handtuchhalter 490 mm

**61209.29**

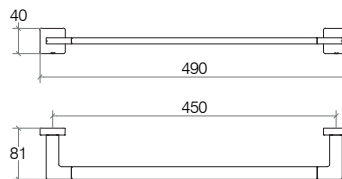

**Ottone cromato**  
Chromed brass  
Laiton chromé  
Verchromtes Messing



.29



€ 66,00 - M

**Portasalvietta 640 mm**

Towel rail 640 mm / Porte-serviettes 640 mm / Handtuchhalter 640 mm

**61210.29**

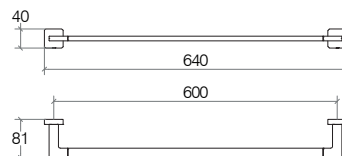

**Ottone cromato**  
Chromed brass  
Laiton chromé  
Verchromtes Messing



.29



€ 75,00 - M

**Dado**

**Portasalviette 840 mm**

Towel rail 840 mm / Porte-serviettes 840 mm / Handtuchhalter 840 mm

**61211.29**

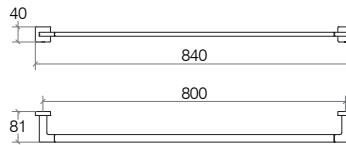

**Ottone cromato**  
Chromed brass  
Laiton chromé  
Verchromtes Messing



.29



€ 85,00 - M

**Portasalviette doppio 650 mm**

Double towel holder 650 mm / Porte-serviettes double 650 mm / Doppelhandtuchhalter 650 mm

**61212.29**

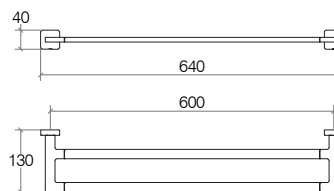

**Ottone cromato**  
Chromed brass  
Laiton chromé  
Verchromtes Messing



.29



€ 126,00 - M

**Portasalviette snodato**

Jointed towel rail / Porte-serviettes articulé / Handtuchhalter schwenkbar

**61213.29**



**Ottone cromato**  
Chromed brass  
Laiton chromé  
Verchromtes Messing



.29



€ 91,00 - M

**Anello portasalviette**

Towel ring / Anneau porte-serviettes / Handtuchring

**61215.29**

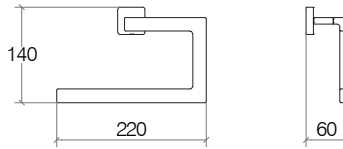

**Ottone cromato**  
Chromed brass  
Laiton chromé  
Verchromtes Messing



.29



€ 56,00 - M

**Portasalviette**

Towel rail / Porte-serviettes / Handtuchhalter

**61214.29**

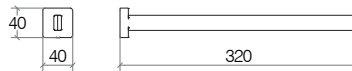

**Ottone cromato**  
Chromed brass  
Laiton chromé  
Verchromtes Messing



.29



€ 38,00 - M

**Ghiera per accessori da appoggio serie 'Dado'**

Tabletop ring for 'Dado' accessories / Anneau de support pour accessoires 'Dado' / Ring für Accessories Serie 'Dado'

**61203.29**

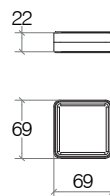

**Ottone cromato**  
Chromed brass  
Laiton chromé  
Verchromtes Messing



.29



€ 30,00 - M

**Dado**

**Supporto singolo**

Single holder / Support individuel / Einzelhalter

**61201.29**

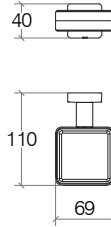

**Ottone cromato**  
 Chromed brass  
 Laiton chromé  
 Verchromtes Messing



.29



€ 24,00 - M

**Supporto doppio**

Double holder / Support double / Doppelhalter

**61202.29**

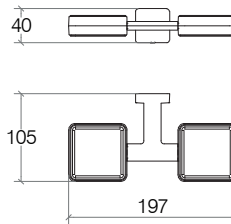

**Ottone cromato**  
 Chromed brass  
 Laiton chromé  
 Verchromtes Messing



.29



€ 35,00 - M

**Bicchiere**

Tumbler / Verre / Becher

**61221.09**

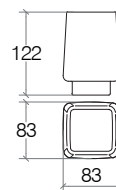

**Ceramica**  
 Ceramic  
 Céramique  
 Keramik



.09



€ 25,00 - M



**Dosapone con leva 150 ml con supporto a muro**

**61216.29.09**

Wall soap dispenser with lever 150 ml / Distributeur savon liquide mural avec levier 150 ml / Wandseifenspender mit Hebel 150 ml

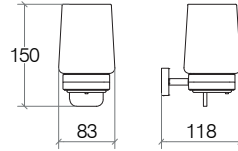

**Ottone cromato**  
Chromed brass  
Laiton chromé  
Verchromtes Messing

**Ceramica**  
Ceramic  
Céramique  
Keramik



.29



€ 73,00 - M

**Dosapone 250 ml**

**61223.09**

Soap dispenser 250 ml / Distributeur savon liquide 250 ml / Seifenspender 250 ml

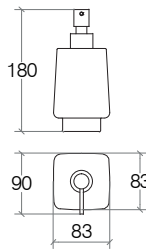

**Ottone cromato**  
Chromed brass  
Laiton chromé  
Verchromtes Messing

**Ceramica**  
Ceramic  
Céramique  
Keramik



€ 49,00 - M

**Portasapone**

**61222.09**

Soap dish / Porte-savon / Seifenschale

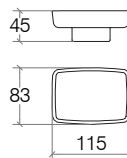

**Ceramica**  
Ceramic  
Céramique  
Keramik



.29



€ 20,00 - M



## Grela

### Accessori

Accessories / Accessoires / Accessoires

#### IT

##### Grela:

nel nostro dialetto, la graticola: quell'oggetto di ferro sul quale vengono appoggiati i cibi per cuocerli sul fuoco o sulle braci.

Una serie di accessori, mobili e complementi dallo stile industrial, adatta ad ambienti moderni e metropolitani.

Accessori: acciaio verniciato bianco o nero goffrato, acciaio inox lucido o nickel nero

Fissaggio con viti a muro

#### EN

##### Grela:

*in our dialect, the grill: that iron object on which food is placed to be cooked on fire or on embers.*

*A range of accessories and furniture characterized by an industrial style, suitable for modern and metropolitan environments.*

*Accessories: embossed white or black painted stainless steel, polished stainless steel or black nickel*

*Screwed to the wall*

#### FR

##### Grela :

*dans notre dialecte vénitien, la grille : accessoire en fer sur lequel les aliments sont placés pour les cuire au feu ou sur les braises.*

*Une série d'accessoires au style industriel, adaptée aux environnements modernes et urbains.*

*Accessoires : acier inox verni blanc ou noir gaufré, acier inox brillant ou nickel noir*

*Fixation au mur avec vis*

#### DE

##### Grela:

*in unserem Dialekt bezeichnet das Wort einen Bratrost: den Gegenstand aus Eisen demnach, auf den Speisen gelegt werden, um sie über dem Feuer oder der Glut zu garen.*

*Eine Serie aus Zubehör, Möbeln und Ergänzungselementen im Industrial-Stil, die sich für ein modernes und weltstädtisches Ambiente eignet.*

*Zubehör: weiß oder schwarz lackiert und gaufriert, Edelstahl glänzend oder Nickel schwarz*

*Wandbefestigung mit Schrauben*

## Grela

Disponibile in acciaio satinato .32 allo stesso prezzo di .29 a partire da maggio 2020  
 Available in satin steel .32 for the same price as .29 from May 2020

### Portarotolo

Toilet paper holder / Porte-rouleau / Toilettenpapierhalter

51701.nn

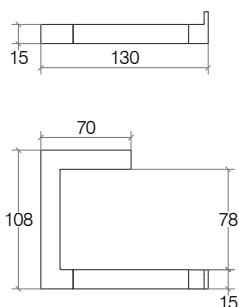

**Acciaio verniciato**  
 Painted steel  
 Acier laqué  
 Lackiertem Stahl



.09 .18  
 € 67,00 - L

**Acciaio inox**  
 Stainless steel  
 Acier inoxydable  
 Edelstahl



.29  
 € 89,00 - L

**Acciaio inox nickel nero**  
 Black nickel stainless steel  
 Acier inoxydable nickel noir  
 Edelstahl Nickel Schwarz



.33  
 € 100,00 - L



### Appendino a L

L shaped hook / Patère L / Hacken L

51702.nn

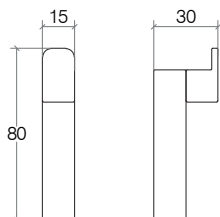

**Acciaio verniciato**  
 Painted steel  
 Acier laqué  
 Lackiertem Stahl



.09 .18  
 € 46,00 - L

**Acciaio inox**  
 Stainless steel  
 Acier inoxydable  
 Edelstahl



.29  
 € 62,00 - L

**Acciaio inox nickel nero**  
 Black nickel stainless steel  
 Acier inoxydable nickel noir  
 Edelstahl Nickel Schwarz



.33  
 € 72,00 - L



### Appendino a G

G shaped hook / Patère G / Hacken G

51703.nn

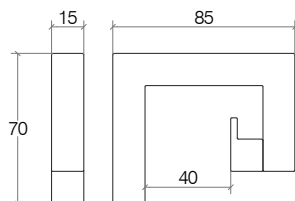

**Acciaio verniciato**  
 Painted steel  
 Acier laqué  
 Lackiertem Stahl



.09 .18  
 € 70,00 - L

**Acciaio inox**  
 Stainless steel  
 Acier inoxydable  
 Edelstahl



.29  
 € 94,00 - L

**Acciaio inox nickel nero**  
 Black nickel stainless steel  
 Acier inoxydable nickel noir  
 Edelstahl Nickel Schwarz



.33  
 € 108,00 - L



Disponibile in acciaio satiné . 32 pour le même prix que . 29 à partir de mai 2020  
 Erhältlich in satiniertem Stahl . 32 zum gleichen Preis wie . 29 ab Mai 2020

**Grela**

**Portasalviette 400 mm**

**51705.nn**

Towel rail 400 mm / Porte-serviettes 400 mm / Handtuchhalter 400 mm

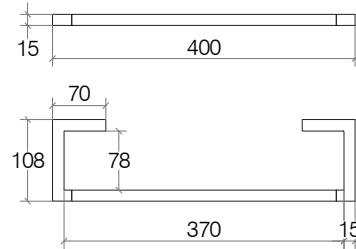

**Acciaio verniciato**  
 Painted steel  
 Acier laqué  
 Lackiertem Stahl

**Acciaio inox**  
 Stainless steel  
 Acier inoxydable  
 Edelstahl

**Acciaio inox nickel nero**  
 Black nickel stainless steel  
 Acier inoxydable nickel noir  
 Edelstahl Nickel Schwarz



**.09 .18**

€ 113,00 - L



**.29**

€ 151,00 - L



**.33**

€ 174,00 - L



**Portasalviette 600 mm**

**51706.nn**

Towel rail 600 mm / Porte-serviettes 600 mm / Handtuchhalter 600 mm

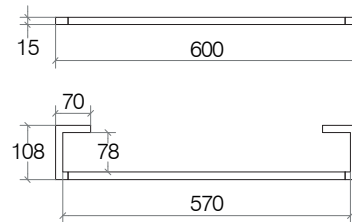

**Acciaio verniciato**  
 Painted steel  
 Acier laqué  
 Lackiertem Stahl

**Acciaio inox**  
 Stainless steel  
 Acier inoxydable  
 Edelstahl

**Acciaio inox nickel nero**  
 Black nickel stainless steel  
 Acier inoxydable nickel noir  
 Edelstahl Nickel Schwarz



**.09 .18**

€ 128,00 - L



**.29**

€ 172,00 - L



**.33**

€ 198,00 - L



## Grela

Disponibile in acciaio satinato .32 allo stesso prezzo di .29 a partire da maggio 2020  
 Available in satin steel .32 for the same price as .29 from May 2020

### Portasalviette - porta accessori 400 mm

**51708.nn**

Towel rail - accessories bar 400 mm / Porte-serviettes - support pour accessoires 400 mm / Handtuchhalter - Halter für Accessoires 400 mm

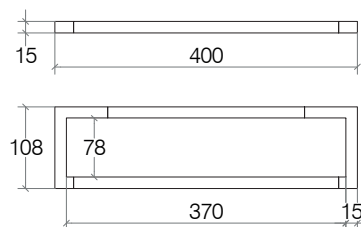

**Acciaio verniciato**  
 Painted steel  
 Acier laqué  
 Lackiertem Stahl



**.09**

**.18**

€ 143,00 - L

**Acciaio inox**  
 Stainless steel  
 Acier inoxydable  
 Edelstahl



**.29**

€ 184,00 - L

**Acciaio inox nickel nero**  
 Black nickel stainless steel  
 Acier inoxydable nickel noir  
 Edelstahl Nickel Schwarz



**.33**

€ 210,00 - L



### Portasalviette - porta accessori 600 mm

**51709.nn**

Towel rail - accessories bar 600 mm / Porte-serviettes - support pour accessoires 600 mm / Handtuchhalter - Halter für Accessoires 600 mm

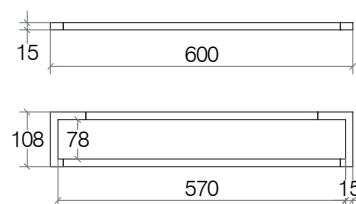

**Acciaio verniciato**  
 Painted steel  
 Acier laqué  
 Lackiertem Stahl



**.09**

**.18**

€ 148,00 - L

**Acciaio inox**  
 Stainless steel  
 Acier inoxydable  
 Edelstahl



**.29**

€ 194,00 - L

**Acciaio inox nickel nero**  
 Black nickel stainless steel  
 Acier inoxydable nickel noir  
 Edelstahl Nickel Schwarz



**.33**

€ 220,00 - L



## Grela

### Portaspazzolini in melamina

Melamine toothbrush holder / Porte-brosses à dents en mélamine / Melamine Zahnputzbecher

5146.nn

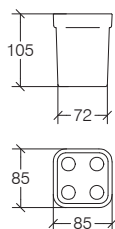

**Alluminio verniciato**  
Painted aluminium  
Aluminium verni  
Lackiertem Aluminium



.09 .17 .18

€ 34,00

**Acciaio inox**  
Stainless steel  
Acier inoxydable  
Edelstahl



.29

€ 34,00

**Metacrilato**  
Methacrylate  
Méthacrylate  
Methacrylat



.80

€ 29,00

### Portasapone in melamina

Melaminesoap dish / Porte-savon en mélamine / Melamine Seifenschale

5147.nn

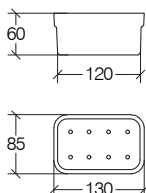

**Alluminio verniciato**  
Painted aluminium  
Aluminium verni  
Lackiertem Aluminium



.09 .17 .18

€ 34,00

**Acciaio inox**  
Stainless steel  
Acier inoxydable  
Edelstahl



.29

€ 34,00

**Metacrilato**  
Methacrylate  
Méthacrylate  
Methacrylat



.80

€ 29,00

### Scatola portaoggetti in melamina

Melamine box / Boîte porte-objets en mélamine / Melamine Schale

5148.nn

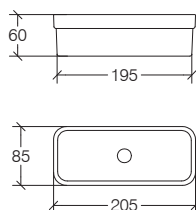

**Alluminio verniciato**  
Painted aluminium  
Aluminium verni  
Lackiertem Aluminium



.09 .17 .18

€ 38,00

**Acciaio inox**  
Stainless steel  
Acier inoxydable  
Edelstahl



.29

€ 38,00

**Metacrilato**  
Methacrylate  
Méthacrylate  
Methacrylat



.80

€ 33,00

### Dosasapone in melamina 250 ml

Melamine soap dispenser 250 ml / Distributeur savon liquide en mélamine 250 ml / Melamine Seifenspender 250 ml

5152.nn

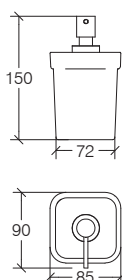

**Alluminio verniciato**  
Painted aluminium  
Aluminium verni  
Lackiertem Aluminium



.09 .17 .18

€ 53,00

**Acciaio inox**  
Stainless steel  
Acier inoxydable  
Edelstahl



.29

€ 53,00





## Saeta

### Accessori

Accessories / Accessoires / Accessoires

#### IT

##### Saeta:

il fulmine, quella cosa che improvvisamente illumina il cielo e altrettanto improvvisamente scompare.

Sottile, discreta ma nel contempo di carattere. Realizzata in alluminio verniciato, disponibile nei colori di tendenza del momento: bianco e nero.

Alluminio verniciato bianco o nero gofrato con inserti in melamina

Fissaggio con viti a muro

#### EN

##### Saeta:

*lightning, that thing that suddenly illuminates the sky and just as suddenly disappears.*

*Thin, discreet but at the same time with character. Made of painted aluminium, available in black and white, today's trendy colours.*

*Embossed white or black painted aluminium with melamine inserts*

*Screwed to the wall*

#### FR

##### Saeta :

*la foudre, ce phénomène météorologique qui illumine soudainement le ciel et disparaît tout aussi rapidement.*

*Fine, discrète mais avec du caractère. En aluminium verni, disponible dans les couleurs tendances actuelles : noir et blanc.*

*Aluminium verni blanc ou noir gaufré avec accessoires en mélamine*

*Fixation au mur avec vis*

#### DE

##### Saeta:

*der Blitz; das, was so plötzlich den Himmel erleuchtet und ebenso plötzlich wieder verschwindet.*

*Fein, unaufdringlich, gleichzeitig aber charaktervoll. Aus lackiertem Aluminium gefertigt, erhältlich in den derzeitigen Trendfarben weiß und schwarz.*

*Weiß oder schwarz lackiertes, gaufriertes Aluminium mit Melamineinsätzen*

*Wandbefestigung mit Schrauben*

## Saeta

### Portarotolo

Toilet paper holder / Porte-rouleau / Toilettenpapierhalter

51811.nn

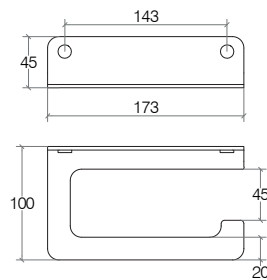

**Alluminio verniciato**  
Painted aluminium  
Aluminium laqué  
Lackiertem Aluminium



€ 31,00 - S

### Portarotolo con riserva

Toilet paper holder with supply / Porte-rouleau avec réserve / Toilettenpapierhalter mit Reserve

5135.nn

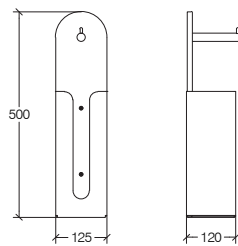

**Alluminio verniciato - Mattstone**  
Painted aluminium - Mattstone  
Aluminium laqué - Mattstone  
Lackiertem Aluminium - Mattstone



€ 130,00 - S

### Appendino doppio

Double hook / Patère double / Hacken doppelt

51813.nn

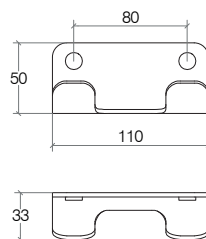

**Alluminio verniciato**  
Painted aluminium  
Aluminium laqué  
Lackiertem Aluminium



€ 29,00 - S

**Portasalviette 454 mm**

**51815.nn**

Towel rail 454 mm / Porte-serviettes 454 mm / Handtuchhalter 454 mm

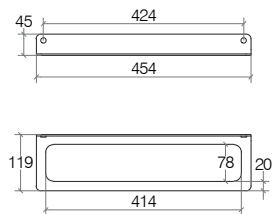

**Alluminio verniciato**  
 Painted aluminium  
 Aluminium laqué  
 Lackiertem Aluminium



€ 54,00 - S



**Portasalviette 634 mm**

**51816.nn**

Towel rail 634 mm / Porte-serviettes 634 mm / Handtuchhalter 634 mm

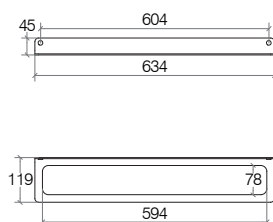

**Alluminio verniciato**  
 Painted aluminium  
 Aluminium laqué  
 Lackiertem Aluminium



€ 62,00 - S



**Mensola 454 mm**

**51817.nn**

Shelf 454 mm / Tablette 454 mm / Ablage 454 mm

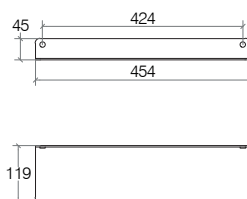

**Alluminio verniciato**  
 Painted aluminium  
 Aluminium laqué  
 Lackiertem Aluminium

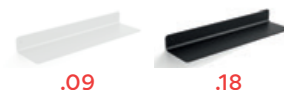

€ 58,00 - S



## Saeta

### Mensola 634 mm

Shelf 634 mm / Tablette 634 mm / Ablage 634 mm

51818.nn

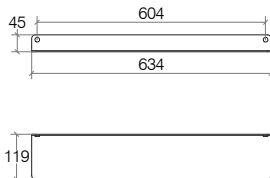
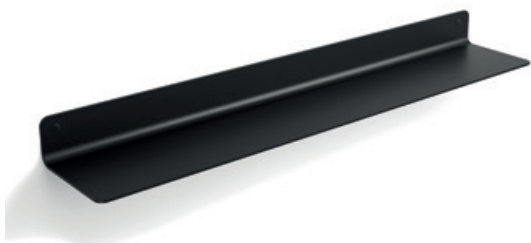

**Alluminio verniciato**  
Painted aluminium  
Aluminium laqué  
Lackiertem Aluminium



€ 66,00 - S

### Supporto con mensola 634 mm, foro sx

Towel holder and accessories bar 634 mm, left hole / Etagère avec p.serviettes - support pour accessoires 634 mm, trou à gauche  
Halter mit Ablage 634 mm Loch Links

51819.nn

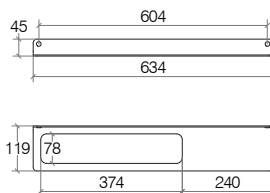
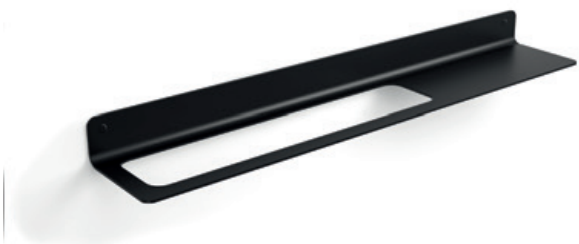

**Alluminio verniciato**  
Painted aluminium  
Aluminium laqué  
Lackiertem Aluminium



€ 68,00 - S

### Supporto con mensola 634 mm, foro dx

Towel holder and accessories bar 634 mm, right hole / Etagère avec p.serviettes - support pour accessoires 634 mm, trou à droite  
Halter mit Ablage 634 mm Loch Rechts

51819DX.nn

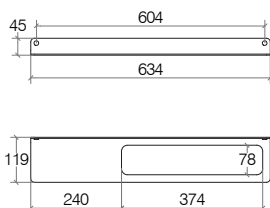

**Alluminio verniciato**  
Painted aluminium  
Aluminium laqué  
Lackiertem Aluminium



€ 68,00 - S

## Saeta

### Portaspazzolini in melamina

Melamine toothbrush holder / Porte-brosses à dents en mélamine / Melamine Zahnputzbecher

5146.nn

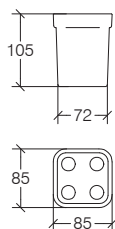

**Alluminio verniciato**  
Painted aluminium  
Aluminium verni  
Lackiertem Aluminium



.09 .17 .18

€ 34,00

**Acciaio inox**  
Stainless steel  
Acier inoxydable  
Edelstahl



.29

€ 34,00

**Metacrilato**  
Methacrylate  
Méthacrylate  
Methacrylat



.80

€ 29,00

### Portasapone in melamina

Melaminesoap dish / Porte-savon en mélamine / Melamine Seifenschale

5147.nn

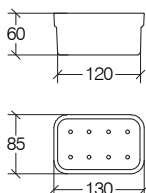

**Alluminio verniciato**  
Painted aluminium  
Aluminium verni  
Lackiertem Aluminium



.09 .17 .18

€ 34,00

**Acciaio inox**  
Stainless steel  
Acier inoxydable  
Edelstahl



.29

€ 34,00

**Metacrilato**  
Methacrylate  
Méthacrylate  
Methacrylat



.80

€ 29,00

### Scatola portaoggetti in melamina

Melamine box / Boîte porte-objets en mélamine / Melamine Schale

5148.nn

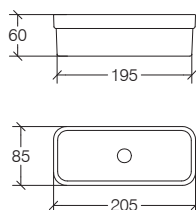

**Alluminio verniciato**  
Painted aluminium  
Aluminium verni  
Lackiertem Aluminium



.09 .17 .18

€ 38,00

**Acciaio inox**  
Stainless steel  
Acier inoxydable  
Edelstahl



.29

€ 38,00

**Metacrilato**  
Methacrylate  
Méthacrylate  
Methacrylat



.80

€ 33,00

### Dosapone in melamina 250 ml

Melamine soap dispenser 250 ml / Distributeur savon liquide en mélamine 250 ml / Melamine Seifenspender 250 ml

5152.nn

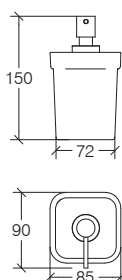

**Alluminio verniciato**  
Painted aluminium  
Aluminium verni  
Lackiertem Aluminium



.09 .17 .18

€ 53,00

**Acciaio inox**  
Stainless steel  
Acier inoxydable  
Edelstahl



.29

€ 53,00



## Baketo

### Accessori

Accessories / Accessoires / Accessoires

#### IT

##### **Baketo:**

bastoncino - ramoscello.

La collezione più iconica, semplice e senza tempo di Lineabeta. La scaletta porta salviette è l'elemento più distintivo e curioso della collezione.

Ottone cromato o verniciato nero opaco con inserti in vetro o porcellana

Fissaggio con viti a muro

#### EN

##### **Baketo:**

stick, twig.

*The simplest, most iconic and timeless collection by Lineabeta. The towel holder ladder is the most distinctive and peculiar element of the collection.*

*Chromed or matt black painted brass with glass or porcelain inserts*

*Screwed to the wall*

#### FR

##### **Baketo :**

petit bâton, brindille.

*La collection la plus emblématique, simple et intemporelle de Lineabeta. L'échelle porte-serviettes est l'éléments plus distinctifs et originaux de la collection.*

*Laiton chromé ou verni noir mat avec accessoires en verre ou en porcelaine*

*Fixation au mur avec vis*

#### DE

##### **Baketo:**

Stäbchen, Zweig.

*Die ikonischste, schlichte und zeitlose Kollektion von Lineabeta. Vertikalstangen und die Handtuchleiter sind die hervorstechenden und interessantesten Elemente der Kollektion.*

*Verchromtes oder mattschwarz lackiertes Messing mit Einsätzen aus Glas oder Porzellan*

*Wandbefestigung mit Schrauben*

## Baketo

### Portarotolo

Toilet paper holder / Porte-rouleau / Toilettenpapierhalter

**5204.nn**

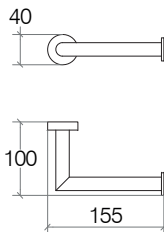

**Ottone cromato**  
Chromed brass  
Laiton chromé  
Verchromtes Messing

**Ottone verniciato**  
Painted brass  
Laiton laqué  
Lackiertem Messing



.29



.22



€ 36,00 - M

### Portarotolo coperto

Toilet paper holder with lid / Porte-rouleau avec couverture / Toilettenpapierhalter mit Deckel

**5203.nn**

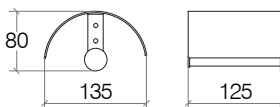

**Ottone cromato**  
Chromed brass  
Laiton chromé  
Verchromtes Messing

**Ottone verniciato**  
Painted brass  
Laiton laqué  
Lackiertem Messing



.29



.22



€ 46,00 - M

### Portarotolo doppio

Double toilet paper holder / Porte-rouleau double / Toilettenpapierhalter doppelt

**5205.nn**

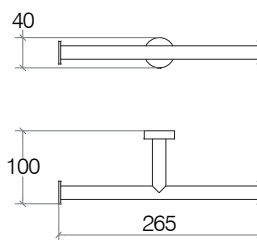

**Ottone cromato**  
Chromed brass  
Laiton chromé  
Verchromtes Messing

**Ottone verniciato**  
Painted brass  
Laiton laqué  
Lackiertem Messing



.29



.22



€ 44,00 - M

### Coppia appendini

2 Hooks / Jeu de 2 patères / Paar Hacken

**5208.nn**

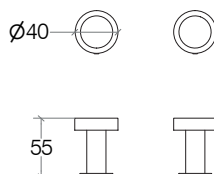

**Ottone cromato**  
Chromed brass  
Laiton chromé  
Verchromtes Messing

**Ottone verniciato**  
Painted brass  
Laiton laqué  
Lackiertem Messing



.29



.22



€ 38,00 - M



## Baketo

### Portasalviette 300 mm

Towel rail 300 mm / Porte-serviettes 300 mm / Handtuchhalter 300 mm

**52091.nn**

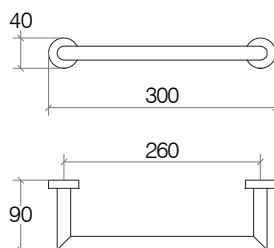

**Ottone cromato**  
Chromed brass  
Laiton chromé  
Verchromtes Messing

**Ottone verniciato**  
Painted brass  
Laiton laqué  
Lackiertem Messing



.29



.22



€ 55,00 - M

### Portasalviette 400 mm

Towel rail 400 mm / Porte-serviettes 400 mm / Handtuchhalter 400 mm

**5210.nn**

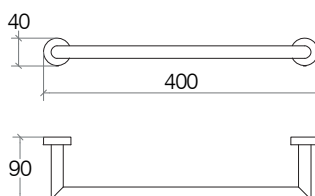

**Ottone cromato**  
Chromed brass  
Laiton chromé  
Verchromtes Messing

**Ottone verniciato**  
Painted brass  
Laiton laqué  
Lackiertem Messing



.29



.22



€ 61,00 - M

### Portasalviette 500 mm

Towel rail 500 mm / Porte-serviettes 500 mm / Handtuchhalter 500 mm

**5211.nn**

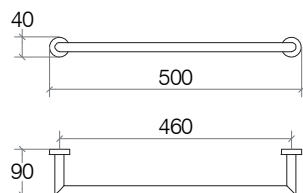

**Ottone cromato**  
Chromed brass  
Laiton chromé  
Verchromtes Messing

**Ottone verniciato**  
Painted brass  
Laiton laqué  
Lackiertem Messing



.29



.22



€ 67,00 - M

### Portasalviette 600 mm

Towel rail 600 mm / Porte-serviettes 600 mm / Handtuchhalter 600 mm

**5212.nn**

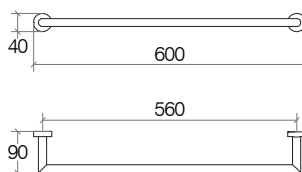

**Ottone cromato**  
Chromed brass  
Laiton chromé  
Verchromtes Messing

**Ottone verniciato**  
Painted brass  
Laiton laqué  
Lackiertem Messing



.29



.22



€ 72,00 - M

## Baketo

### Portasalviette doppio 600 mm

Double towel rail 600 mm / Porte-serviettes double 600 mm / Doppelhandtuchhalter 600 mm

5214.nn

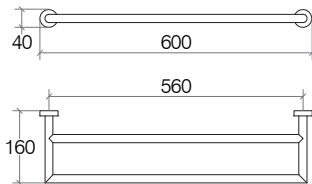

**Ottone cromato**  
Chromed brass  
Laiton chromé  
Verchromtes Messing

**Ottone verniciato**  
Painted brass  
Laiton laqué  
Lackiertem Messing



.29



.22



€ 86,00 - M

### Griglia portasalviette

Towel shelf / Rack porte-serviettes / Handtuchablage

5216.nn

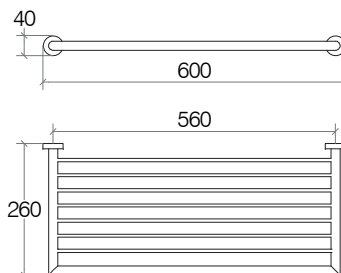

**Ottone cromato**  
Chromed brass  
Laiton chromé  
Verchromtes Messing

**Ottone verniciato**  
Painted brass  
Laiton laqué  
Lackiertem Messing



.29



.22



€ 132,00 - M

### Scaletta portasalviette a muro

Wall towel holder / Echelle porte-serviettes mural / Handtuchständer mit Anlehnung am Wand

5233.nn

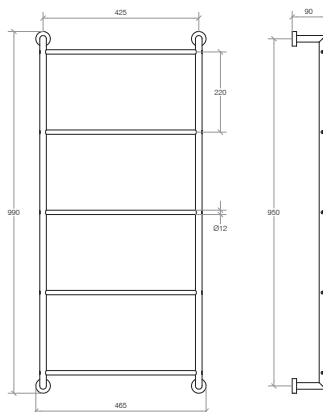

**Ottone cromato**  
Chromed brass  
Laiton chromé  
Verchromtes Messing

**Ottone verniciato**  
Painted brass  
Laiton laqué  
Lackiertem Messing



.29

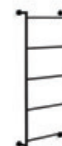

.22



€ 220,00 - M

## Baketo

### Portasalviette doppio snodato

Double jointed towel rail / Porte-serviettes articulé double / Doppelhandtuchhalter schwenkbar

52152.nn

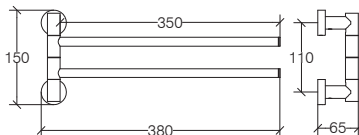

**Ottone cromato**  
Chromed brass  
Laiton chromé  
Verchromtes Messing



.29

**Ottone verniciato**  
Painted brass  
Laiton laqué  
Lackiertem Messing



.22



€ 95,00 - M

### Anello portasalviette

Towel ring / Anneau porte-serviettes / Handtuchring

52153.nn

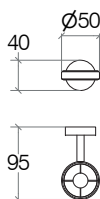

**Ottone cromato**  
Chromed brass  
Laiton chromé  
Verchromtes Messing



.29

**Ottone verniciato**  
Painted brass  
Laiton laqué  
Lackiertem Messing



.22



€ 30,00 - M

### Supporto singolo

Single holder / Support individuel / Halter lose

52011.nn

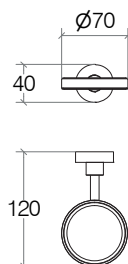

**Ottone cromato**  
Chromed brass  
Laiton chromé  
Verchromtes Messing



.29

**Ottone verniciato**  
Painted brass  
Laiton laqué  
Lackiertem Messing



.22



€ 26,00 - M

## Baketo

### Supporto portascopino

Toilet brush holder / Support porte-balai / Halter lose für Toilettenbürsten

**52061.nn**

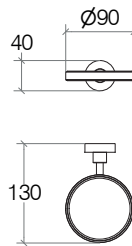

**Ottone cromato**  
Chromed brass  
Laiton chromé  
Verchromtes Messing



**.29**

**Ottone verniciato**  
Painted brass  
Laiton laqué  
Lackiertem Messing



**.22**



€ 27,00 - M

### Portascopino

Towel brush / Porte-balai / Toilettenbürstengarnitur

**55062.nn**

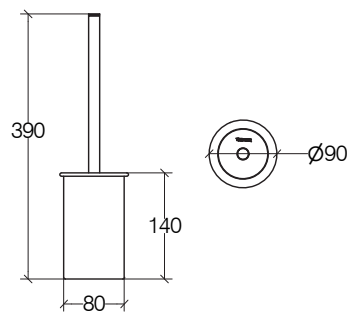

**Vetro acidato**  
Etched glass  
Verre dépoli  
Geätztes Glas



**.81**

**.81.22**

**Porcellana**  
Porcelaine  
Porcelaine  
Porzellan



**.09**

**.09.22**

€ 41,00

### Dosapone a parete 180 ml

Wall soap dispenser 180 ml / Distributeur savon liquide mural 180 ml / Wandseifenspender 180 ml

**5217.nn**

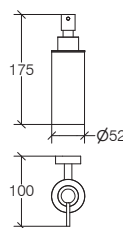

**Ottone cromato**  
Chromed brass  
Laiton chromé  
Verchromtes Messing



**.29**

**Ottone verniciato**  
Painted brass  
Laiton laqué  
Lackiertem Messing



**.22**



€ 59,00 - M

## Baketo

### Coppia supporti mensola

Shelf wall bearing (1 pair) / Paire de supports pour tablette / Paar Halter für Ablage

**5234.nn**

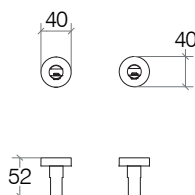

**Ottone cromato**  
Chromed brass  
Laiton chromé  
Verchromtes Messing



.29

**Ottone verniciato**  
Painted brass  
Laiton laqué  
Lackiertem Messing



.22



€ 36,00 - M

### Mensola vetro temperato 392 mm

Glass shelf 392 mm / Étagère en verre 392 mm / Glasablage 392 mm

**5276.81**

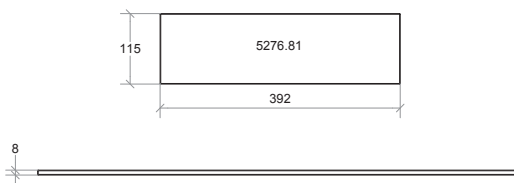

**Vetro acidato**  
Etched glass  
Verre dépoli  
Geätztes Glas

€ 30,00

### Mensola vetro temperato 492 mm

Glass shelf 492 mm / Étagère en verre 492 mm / Glasablage 492 mm

**5277.81**

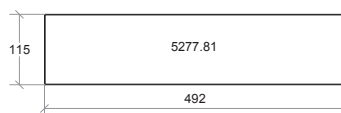

**Vetro acidato**  
Etched glass  
Verre dépoli  
Geätztes Glas

€ 33,00

### Mensola vetro temperato 592 mm

Glass shelf 592 mm / Étagère en verre 592 mm / Glasablage 592 mm

**5278.81**

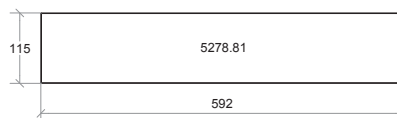

**Vetro acidato**  
Etched glass  
Verre dépoli  
Geätztes Glas

€ 36,00

### Mensola vetro temperato 792 mm

Glass shelf 792 mm / Étagère en verre 792 mm / Glasablage 792 mm

**5279.81**

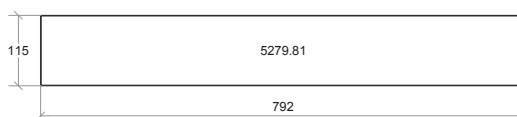

**Vetro acidato**  
Etched glass  
Verre dépoli  
Geätztes Glas

€ 43,00

## Baketo

### Bicchiere

Tumbler / Verre / Becher

**55003.nn**

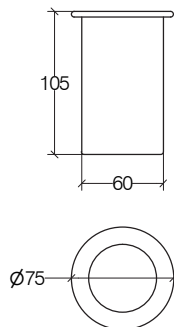

Porcellana  
Porcelaine  
Porcelaine  
Porzellan



.09

Vetro acidato  
Etched glass  
Verre dépoli  
Geätztes Glas



.81

€ 16,00

### Portasapone

Soap dish / Porte-savon / Seifenschale

**55004.nn**

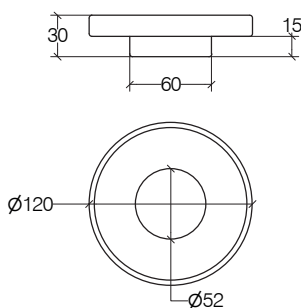

Porcellana  
Porcelaine  
Porcelaine  
Porzellan



.09

Vetro acidato  
Etched glass  
Verre dépoli  
Geätztes Glas



.81

€ 16,00

### Griglietta in silicone antiscivolo per Art. 55004 (20 pezzi assortiti in 4 colori)

20 grip grids for soap dish 55004 / Grille en silicon 20 picks pour porte savon 55004 / 20 Einlagen für Seifenschale 55004

**5200.nn**

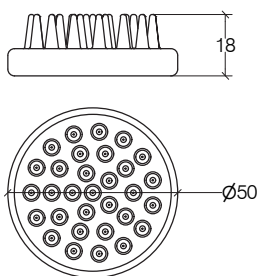

Silicone  
Silicon  
Silicone  
Silikon



.09



.15



.16



.17

€ 38,00

### Dosapapone 200 ml

Soap dispenser 200 ml / Distributeur savon liquide 200 ml / Seifenspender 200 ml

**55006.nn**

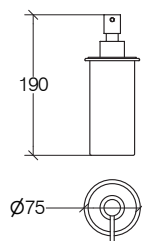

Porcellana  
Porcelaine  
Porcelaine  
Porzellan



.09



.09.22

Vetro acidato  
Etched glass  
Verre dépoli  
Geätztes Glas



.81



.81.22

€ 40,00

**TA-BAKETO FIX**

**5210.29**

**Portasalviette 400 mm**

Towel rail 400 mm / Porte-serviettes 400 mm / Handtuchhalter 400 mm

**5208.29**

**Coppia appendini**

2 Hooks / Jeu de 2 patères / Paar Hacken

**5204.29**

**Portarotolo**

Toilet paper holder / Porte-rouleau / Toilettenpapierhalter

**50042.29**

**Portascopino**

Towel brush / Porte-balai / Toilettenbürstengarnitur

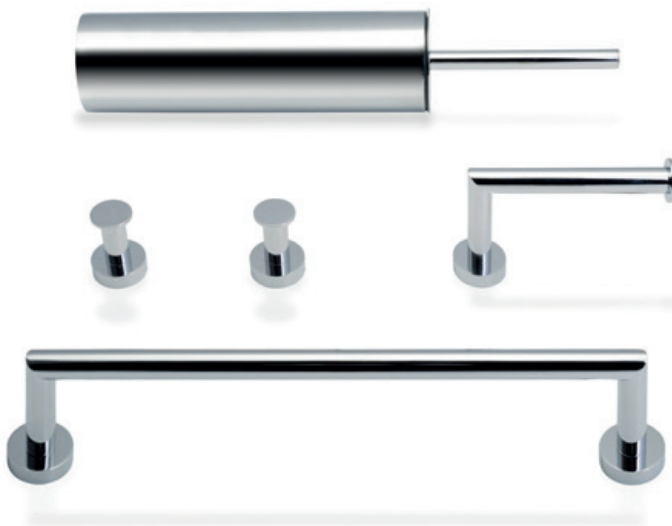

**Ottone cromato**  
 Chromed brass  
 Laiton chromé  
 Verchromtes Messing

**Ottone verniciato**  
 Painted brass  
 Laiton laqué  
 Lackiertem Messing

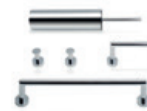

.29

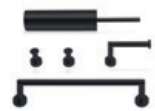

.22

€ 204,00 - M





## Roersa

### Accessori

Accessories / Accessoires / Accessoires

#### IT

##### Roersa:

rovesciata - capovolta.

Questa collezione, ispirata alle sorelle Curvá e Saeta, viene proposta in acciaio inox AISI 316, inalterabile nel tempo. Interessanti le mensole-griglia, perfette per dotare l'ambiente doccia con portaoggetti non banali.

Acciaio Aisi 316 lucido o satinato con inserti in melamina

Fissaggio con viti a muro

#### EN

##### Roersa:

overturned, upside-down.

*This collection, inspired by CURVÁ and SAETA, is offered in AISI 316 stainless steel, a material that does not change over time. The grid shelves are intriguing and ideal for equipping the shower room with original storage places.*

*Polished or satin-finished Aisi 316 steel with melamine inserts*

*Screwed to the wall*

#### FR

##### Roersa :

à l'envers, renversée.

*Cette collection, inspirée par les séries CURVÀ et SAETA, est proposée en acier inox AISI 316, inaltérable dans le temps. Les étagères avec grille sont idéales pour équiper l'espace-douche d'un porte-objets original.*

*Acier AISI 316 brillant ou satiné avec accessoires en mélamine*

*Fixation au mur avec vis*

#### DE

##### Roersa:

umgekehrt, umgedreht.

*Diese Kollektion, die Anleihen bei den Schwestern CURVÁ und SAETA macht, wird in alterungsbeständigem Edelstahl AISI 316 angeboten. Interessant die Gitterkonsolen, die ideal sind, um die Dusche mit beileibe nicht alltäglichen Ablagen auszustatten.*

*Stahl AISI 316 glänzend oder satiniert mit Melanineinsätzen*

*Wandbefestigung mit Schrauben*

## Roersa

### Portarotolo

Toilet paper holder / Porte-rouleau / Toilettenpapierhalter

5161.nn

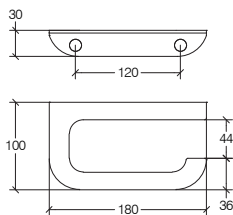

**Acciaio inox lucido**  
Polished stainless steel  
Acier inoxydable brillant  
Poliert Edelstahl



.29

**Acciaio inox satinato**  
Satinated stainless steel  
Acier inoxydable satiné  
Vereist Edelstahl



.32



AISI 316



€ 93,00 - L

### Appendino doppio

Double hook / Patère double / Hacken doppelt

5160.nn

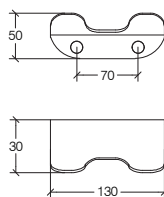

**Acciaio inox lucido**  
Polished stainless steel  
Acier inoxydable brillant  
Poliert Edelstahl



.29

**Acciaio inox satinato**  
Satinated stainless steel  
Acier inoxydable satiné  
Vereist Edelstahl



.32



AISI 316



€ 93,00 - L

### Portasalvietta / Porta accessori 460 mm

Towel holder accessories bar 460 mm / Porte-serviettes - support pour accessoires (à équiper) 460 mm  
Handtuchhalter Halter für Accessoires 460 mm

5164.nn

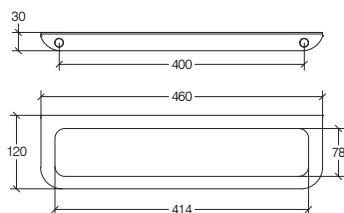

**Acciaio inox lucido**  
Polished stainless steel  
Acier inoxydable brillant  
Poliert Edelstahl



.29

**Acciaio inox satinato**  
Satinated stainless steel  
Acier inoxydable satiné  
Vereist Edelstahl



.32



AISI 316



€ 137,00 - L

**Portasalviette / Porta accessori 640 mm**

**5165.nn**

Towel holder accessories bar 640 mm / Porte-serviettes - support pour accessoires (à équiper) 640 mm  
Accessoires und Handtuchhalter 640 mm

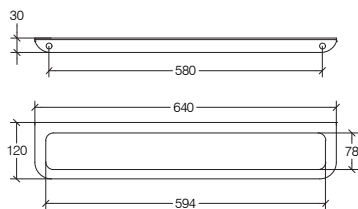

**Acciaio inox lucido**  
Polished stainless steel  
Acier inoxydable brillant  
Poliert Edelstahl



**.29**

**Acciaio inox satinato**  
Satinated stainless steel  
Acier inoxydable satiné  
Vereist Edelstahl



**.32**



€ 166,00 - L

**Supporto con mensola 800 mm, foro sx**

**5169.nn**

Towel holder and accessories bar 800 mm, left hole / Etagère avec p.serviettes - support pour accessoires 800 mm, trou à gauche  
Halter mit Ablage 800 mm Loch Links

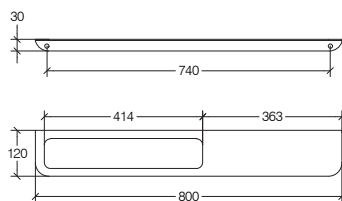

**Acciaio inox lucido**  
Polished stainless steel  
Acier inoxydable brillant  
Poliert Edelstahl



**.29**

**Acciaio inox satinato**  
Satinated stainless steel  
Acier inoxydable satiné  
Vereist Edelstahl



**.32**



€ 197,00 - L

**Mensola doccia angolare 200 mm**

**5170.nn**

Shower shelf corner 200 mm / Etagère douche angulaire 200 mm / Duschablage eckig 200 mm

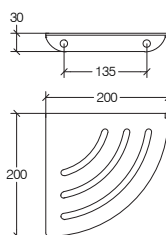

**Acciaio inox lucido**  
Polished stainless steel  
Acier inoxydable brillant  
Poliert Edelstahl



**.29**

**Acciaio inox satinato**  
Satinated stainless steel  
Acier inoxydable satiné  
Vereist Edelstahl



**.32**



€ 114,00 - L

## Roersa

### Mensola doccia 300 mm

Shower shelf 300 mm / Etagère douche 300 mm / Duschablage 300 mm

5171.nn

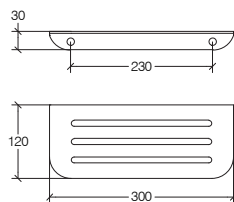
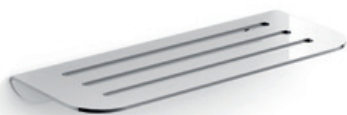

**Acciaio inox lucido**  
Polished stainless steel  
Acier inoxydable brillant  
Poliert Edelstahl



.29

**Acciaio inox satinato**  
Satinated stainless steel  
Acier inoxydable satiné  
Vereist Edelstahl



.32



AISI  
316



€ 120,00 - L

### Mensola doccia 600 mm

Shower shelf 600 mm / Etagère douche 600 mm / Duschablage 600 mm

5172.nn

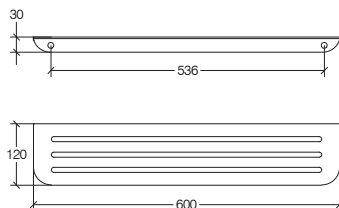

**Acciaio inox lucido**  
Polished stainless steel  
Acier inoxydable brillant  
Poliert Edelstahl



.29

**Acciaio inox satinato**  
Satinated stainless steel  
Acier inoxydable satiné  
Vereist Edelstahl



.32



AISI  
316



€ 177,00 - L

**Portaspazzolini in melamina**

Melamine toothbrush holder / Porte-brosses à dents en mélamine / Melamine Zahnputzbecher

**5146.nn**

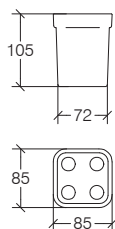

**Alluminio verniciato**  
Painted aluminium  
Aluminium verni  
Lackiertem Aluminium



**.09 .17 .18**

**€ 34,00**

**Acciaio inox**  
Stainless steel  
Acier inoxydable  
Edelstahl



**.29**

**€ 34,00**

**Metacrilato**  
Methacrylate  
Méthacrylate  
Methacrylat



**.80**

**€ 29,00**

**Portasapone in melamina**

Melaminesoap dish / Porte-savon en mélamine / Melamine Seifenschale

**5147.nn**

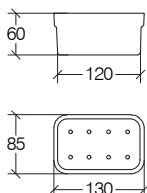

**Alluminio verniciato**  
Painted aluminium  
Aluminium verni  
Lackiertem Aluminium



**.09 .17 .18**

**€ 34,00**

**Acciaio inox**  
Stainless steel  
Acier inoxydable  
Edelstahl



**.29**

**€ 34,00**

**Metacrilato**  
Methacrylate  
Méthacrylate  
Methacrylat



**.80**

**€ 29,00**

**Scatola portaoggetti in melamina**

Melamine box / Boîte porte-objets en mélamine / Melamine Schale

**5148.nn**

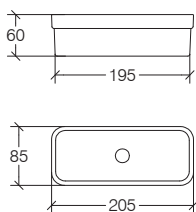

**Alluminio verniciato**  
Painted aluminium  
Aluminium verni  
Lackiertem Aluminium



**.09 .17 .18**

**€ 38,00**

**Acciaio inox**  
Stainless steel  
Acier inoxydable  
Edelstahl



**.29**

**€ 38,00**

**Metacrilato**  
Methacrylate  
Méthacrylate  
Methacrylat



**.80**

**€ 33,00**

**Dosasapone in melamina 250 ml**

Melamine soap dispenser 250 ml / Distributeur savon liquide en mélamine 250 ml / Melamine Seifenspender 250 ml

**5152.nn**

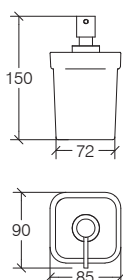

**Alluminio verniciato**  
Painted aluminium  
Aluminium verni  
Lackiertem Aluminium



**.09 .17 .18**

**€ 53,00**

**Acciaio inox**  
Stainless steel  
Acier inoxydable  
Edelstahl



**.29**

**€ 53,00**



## Curv`a

### Accessori

Accessories / Accessoires / Accessoires

#### IT

##### Curv`a:

curva - sinuosa.

Una serie che ricorda le forme morbide delle donne italiane. Ha un fissaggio a muro a scomparsa, che la fa percepire come sospesa nello spazio. Designer: Emiliano Aiardi - Lineabeta LAB 2013

Alluminio verniciato bianco o nero goffrato con inserti in melamina

Fissaggio con viti a muro

#### EN

##### Curv`a:

curved - sinuous.

*A range that is reminiscent of the curvy shapes of Italian women. It has a concealed wall fixing, which makes it appear as if it were suspended in space. Designer: Emiliano Aiardi - Lineabeta LAB 2013*

*Embossed white or black painted aluminium with melamine inserts*

*Screwed to the wall*

#### FR

##### Curv`a :

courbe - virage.

*Une s`erie qui rappelle les formes des belles italiennes. Elle est dot`ee d'une fixation murale dissimul`ee, lui donnant l'impression d'`etre suspendue dans l'espace. Concepteur : Emiliano Aiardi - Lineabeta LAB 2013*

*Aluminium verni blanc ou noir gaufr`e avec accessoires en m`elamine*

*Fixation au mur avec vis*

#### DE

##### Curv`a:

„gebogen“, „gewunden“.

*Eine Serie, die an die weichen Formen der italienischen Frauen erinnert. Mit ihrer versenkten Wandbefestigung wird sie im Raum als schwebend wahrgenommen. Designer: Emiliano Aiardi - Lineabeta LAB 2013*

*Weiß oder schwarz lackiertes, gaufriertes Aluminium mit Melamineins`atzen*

*Wandbefestigung mit Schrauben*

## Curvè

### Portarotolo

Toilet paper holder / Porte-rouleau / Toilettenpapierhalter

5151.nn

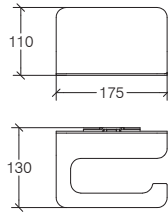

**Alluminio verniciato**  
Painted aluminium  
Aluminium laqué  
Lackiertem Aluminium



.09

.18



€ 40,00 - M

### Appendino doppio

Double hook / Patère double / Hacken doppelt

5150.nn

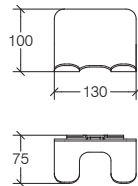

**Alluminio verniciato**  
Painted aluminium  
Aluminium laqué  
Lackiertem Aluminium



.09

.18



€ 36,00 - M

### Portasalviette / Porta accessori 460 mm

Towel holder - accessories bar 460 mm / Porte-serviettes - support pour accessoires (à équiper) 460 mm  
Handtuchhalter Halter für Accessoires 460 mm

5144.nn

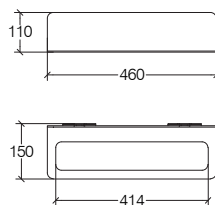

**Alluminio verniciato**  
Painted aluminium  
Aluminium laqué  
Lackiertem Aluminium



.09

.18



€ 83,00 - M



**Portasalviette / Porta accessori 640 mm**

**5145.nn**

Towel holder - accessories bar 640 mm / Porte-serviettes - support pour accessoires (à équiper) 640 mm  
Handtuchhalter Halter für Accessoires 640 mm

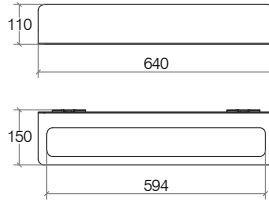

**Alluminio verniciato**  
*Painted aluminium*  
*Aluminium laqué*  
*Lackiertem Aluminium*



€ 91,00 - M

**Mensola 460 mm**

**5142.nn**

Shelf 460 mm / Tablette 460 mm / Ablage 460 mm

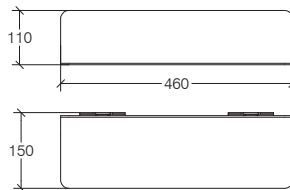

**Alluminio verniciato**  
*Painted aluminium*  
*Aluminium laqué*  
*Lackiertem Aluminium*



€ 80,00 - M

**Mensola 640 mm**

**5143.nn**

Shelf 640 mm / Etagère 640 mm / Ablage 640 mm

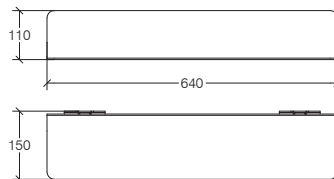

**Alluminio verniciato**  
*Painted aluminium*  
*Aluminium laqué*  
*Lackiertem Aluminium*



€ 91,00 - M

## Curvà

### Supporto con mensola 800 mm, foro sx

Towel holder and accessories bar 800 mm, left hole / Etagère avec porte-serviettes - support pour accessoires 800 mm, trou à gauche  
Halter mit Ablage 800 mm Loch Links

5149.nn

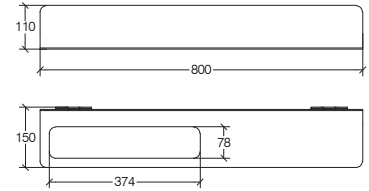

Alluminio verniciato  
Painted aluminium  
Aluminium laqué  
Lackiertem Aluminium



.09

.18

€ 105,00 - M



### Supporto con mensola 800 mm, foro dx

Towel holder and accessories bar 800 mm, right hole / Etagère avec porte-serviettes - support pour accessoires 800 mm, trou à droite  
Halter mit Ablage 800 mm Loch Rechts

5149DX.nn

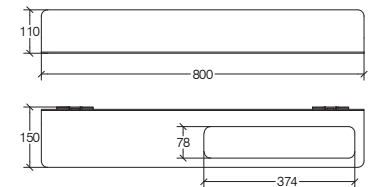

Alluminio verniciato  
Painted aluminium  
Aluminium laqué  
Lackiertem Aluminium



.09

.18

€ 105,00 - M



## Curvà

### Portaspazzolini in melamina

Melamine toothbrush holder / Porte-brosses à dents en mélamine / Melamine Zahnputzbecher

5146.nn

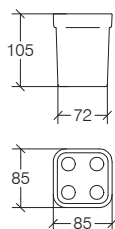

**Alluminio verniciato**  
Painted aluminium  
Aluminium verni  
Lackiertem Aluminium



.09 .17 .18

€ 34,00

**Acciaio inox**  
Stainless steel  
Acier inoxydable  
Edelstahl



.29

€ 34,00

**Metacrilato**  
Methacrylate  
Méthacrylate  
Methacrylat



.80

€ 29,00

### Portasapone in melamina

Melaminesoap dish / Porte-savon en mélamine / Melamine Seifenschale

5147.nn

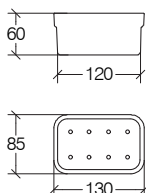

**Alluminio verniciato**  
Painted aluminium  
Aluminium verni  
Lackiertem Aluminium



.09 .17 .18

€ 34,00

**Acciaio inox**  
Stainless steel  
Acier inoxydable  
Edelstahl



.29

€ 34,00

**Metacrilato**  
Methacrylate  
Méthacrylate  
Methacrylat



.80

€ 29,00

### Scatola portaoggetti in melamina

Melamine box / Boîte porte-objets en mélamine / Melamine Schale

5148.nn

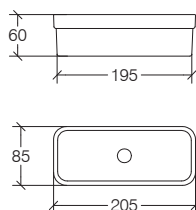

**Alluminio verniciato**  
Painted aluminium  
Aluminium verni  
Lackiertem Aluminium



.09 .17 .18

€ 38,00

**Acciaio inox**  
Stainless steel  
Acier inoxydable  
Edelstahl



.29

€ 38,00

**Metacrilato**  
Methacrylate  
Méthacrylate  
Methacrylat



.80

€ 33,00

### Dosasapone in melamina 250 ml

Melamine soap dispenser 250 ml / Distributeur savon liquide en mélamine 250 ml / Melamine Seifenspender 250 ml

5152.nn

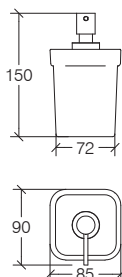

**Alluminio verniciato**  
Painted aluminium  
Aluminium verni  
Lackiertem Aluminium



.09 .17 .18

€ 53,00

**Acciaio inox**  
Stainless steel  
Acier inoxydable  
Edelstahl



.29

€ 53,00



## Icselle

### Accessori

Accessories / Accessoires / Accessoires

#### IT

##### Icselle:

grande, maggiorata, come le taglie massime dei capi di abbigliamento.

Pochi iconici pezzi, in particolare le barre porta salviette attrezzabili con inserti in preziosa porcellana bone china.

Alluminio cromato, verniciato bianco o nero gofrato

Fissaggio con viti a muro

#### EN

##### Icselle:

*large, oversized, like the largest clothing size.*

*Few iconic pieces, in particular the towel rails that can be customized with inserts in precious bone china.*

*Embossed white or black painted and chromed aluminium*

*Screwed to the wall*

#### FR

##### Icselle :

*grande, surdimensionnée, comme les grandes tailles dans le prêt-à-porter.*

*Une sélection de pièces emblématiques, en particulier les porte-serviettes, qui peuvent être complétées d'accessoires en porcelaine Bone China.*

*Aluminium chromé, verni blanc ou noir gaufré*

*Fixation au mur avec vis*

#### DE

##### Icselle:

*groß, überdimensioniert, wie die Übergroßen bei Kleidungsstücken.*

*Wenige, aber ikonische Teile, insbesondere die Handtuchstangen, die mit Einsätzen aus dem kostbaren Knochenporzellan „Bone China“ versehen werden können.*

*Weiß oder schwarz lackiertes, gaufriertes Verchromtes Aluminium*

*Wandbefestigung mit Schrauben*

## Icsele

### Portarotolo

Toilet paper holder / Porte-rouleau / Toilettenpapierhalter

52886.nn

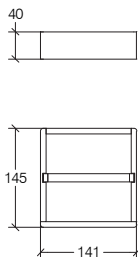

**Alluminio verniciato**  
Painted aluminium  
Aluminium laqué  
Lackiertem Aluminium



.09

.18

€ 70,00 - L

**Alluminio cromato**  
Chromed aluminium  
Aluminium chromé  
Verchromtes Aluminium



.29

€ 94,00 - L



### Portarotolo ad incollo per vassoio

Toilet paper holder to be glued for tray / Porte-rouleau a coller sur plateau / Toilettenpapierhalter zum Kleben für Ablage

52880.nn

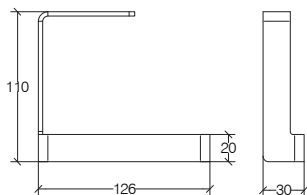

**Alluminio verniciato**  
Painted aluminium  
Aluminium laqué  
Lackiertem Aluminium



.09

.18

€ 39,00 - L



### Appendino doppio

Double hook / Patère double / Hacken doppelt

52885.nn

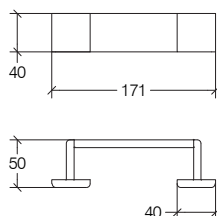

**Alluminio verniciato**  
Painted aluminium  
Aluminium laqué  
Lackiertem Aluminium



.09

.18

€ 80,00 - L

**Alluminio cromato**  
Chromed aluminium  
Aluminium chromé  
Verchromtes Aluminium



.29

€ 106,00 - L



**Supporto 160 mm**

**52881.nn**

Bracket 160 mm / Support 160 mm / Halter 160 mm

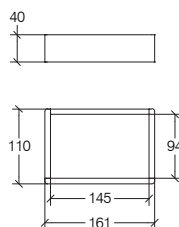

**Alluminio verniciato**  
Painted aluminium  
Aluminium laqué  
Lackiertem Aluminium

**Alluminio cromato**  
Chromed aluminium  
Aluminium chromé  
Verchromtes Aluminium



**.09** **.18**  
€ 57,00 - L



**.29**  
€ 72,00 - L



**Portasalvietta / porta accessori 315 mm**

**52882.nn**

Towel holder accessories bar 315 mm / Porte-serviettes support pour accessoires (à équiper) 315 mm  
Handtuchhalter Halter für Accessoires 315 mm

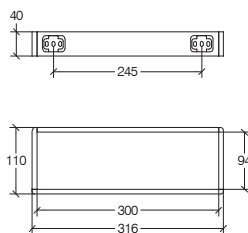

**Alluminio verniciato**  
Painted aluminium  
Aluminium laqué  
Lackiertem Aluminium

**Alluminio cromato**  
Chromed aluminium  
Aluminium chromé  
Verchromtes Aluminium



**.09** **.18**  
€ 62,00 - L



**.29**  
€ 88,00 - L



**Portasalvietta / porta accessori 625 mm**

**52883.nn**

Towel holder accessories bar 625 mm / Porte-serviettes support support pour accessoires (à équiper) 625 mm  
Handtuchhalter Halter für Accessoires 625 mm

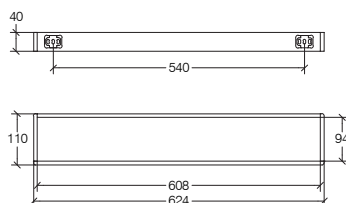

**Alluminio verniciato**  
Painted aluminium  
Aluminium laqué  
Lackiertem Aluminium

**Alluminio cromato**  
Chromed aluminium  
Aluminium chromé  
Verchromtes Aluminium



**.09** **.18**  
€ 74,00 - L



**.29**  
€ 116,00 - L



## Icselle

### Portasalviette / porta accessori 930 mm

Towel holder accessories bar 930 mm / Porte-serviettes support support pour accessoires (à équiper) 930 mm  
Handtuchhalter Halter für Accessoires 930 mm

52884.nn

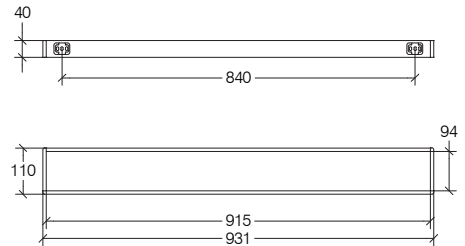

**Alluminio verniciato**  
Painted aluminium  
Aluminium laqué  
Lackiertem Aluminium



.09 .18

€ 91,00 - L

**Alluminio cromato**  
Chromed aluminium  
Aluminium chromé  
Verchromtes Aluminium



.29

€ 146,00 - L



### Bicchiere

Tumbler / Verre / Becher

52891.09

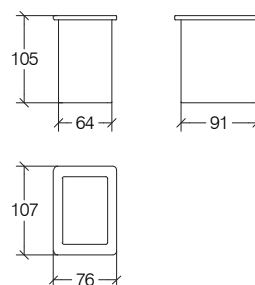

**Porcellana**  
Porcelaine  
Porcelaine  
Porzellan



.09

€ 40,00



**Portasapone**

Soap holder / Porte-savon / Seifenschale

**52892.09**

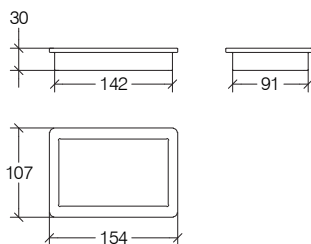

Porcellana  
Porcelaine  
Porcelaine  
Porzellan



.09

€ 31,00

**Vassoio**

Tray / Plateau / Ablage

**52893.09**

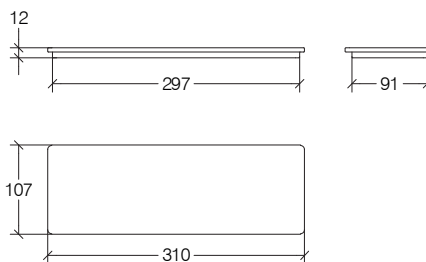

Porcellana  
Porcelaine  
Porcelaine  
Porzellan



.09

€ 51,00

**Dosasapone**

Soap dispenser / Distributeur savon liquide / Seifenspender

**52894.nn**

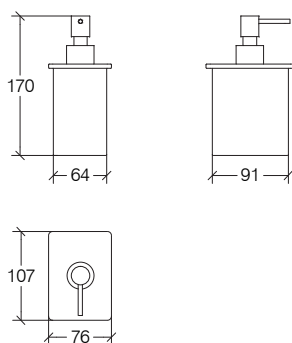

Porcellana  
Porcelaine  
Porcelaine  
Porzellan



.09



.09.18

€ 57,00



## **Skuara**

### **Accessori**

*Accessories / Accessoires / Accessoires*

#### **IT**

##### **Skuara:**

diritta - precisa.

Una serie diventata iconica del nostro brand. Ideando questa collezione siamo stati precursori di un trend poi diventato consuetudine per le nostre collezioni più identificative.

Ottone cromato con inserti in ceramica o acciaio

Fissaggio con viti a muro

#### **EN**

##### **Skuara:**

*straight, accurate.*

*A range that has become iconic for our brand. This collection turned us into the pioneers of a trend that later became the tradition for our most identifiable collections.*

*Chromed brass with ceramic or steel inserts*

*Screwed to the wall*

#### **FR**

##### **Skuara :**

*droite, précise.*

*Une série devenue iconique pour notre marque. En concevant cette collection, nous avons été les précurseurs d'une tendance qui est devenue plus tard la référence de nos collections les plus identifiables.*

*Laiton chromé avec accessoires en céramique ou en acier*

*Fixation au mur avec vis*

#### **DE**

##### **Skuara:**

*"gerade" "präzise".*

*Eine Serie, die zur Ikone unserer Marke geworden ist. Durch die Schaffung dieser Kollektion haben wir einen Trend vorweggenommen, der später für unsere prägendsten Kollektionen zur Gewohnheit geworden ist.*

*Verchromtes Messing mit Einsätzen aus Keramik oder Stahl*

*Wandbefestigung mit Schrauben*

## Skuara

### Portarotolo

Toilet paper holder / Porte-rouleau / Toilettenpapierhalter

**52806.29**

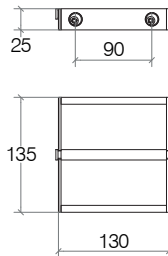

Ottone cromato  
Chromed brass  
Laiton chromé  
Verchromtes Messing



.29



€ 70,00 - M

### Portarotolo doppio

Double toilet paper holder / Porte-rouleau double / Toilettenpapierhalter doppelt

**52807.29**

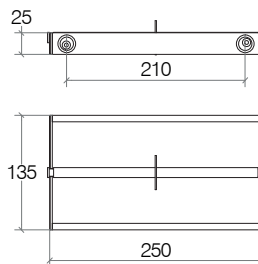
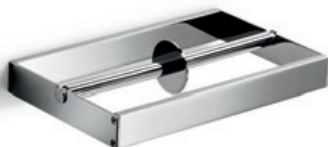

Ottone cromato  
Chromed brass  
Laiton chromé  
Verchromtes Messing



.29



€ 83,00 - M

### Appendino doppio

Double hook / Patère double / Hacken doppelt

**52853.29**

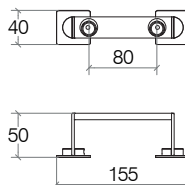

Ottone cromato  
Chromed brass  
Laiton chromé  
Verchromtes Messing



.29



€ 57,00 - M

### Supporto 82 mm

Bracket 82 mm / Support 82 mm / Halter 82 mm

**52808.29**

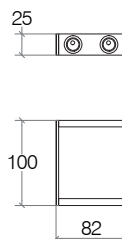

Ottone cromato  
Chromed brass  
Laiton chromé  
Verchromtes Messing



.29



€ 49,00 - M

## Skuara

### Supporto 100 mm

Bracket 100 mm / Support 100 mm / Halter 100 mm

**52810.29**

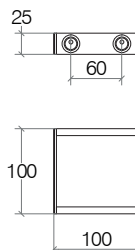

**Ottone cromato**  
Chromed brass  
Laiton chromé  
Verchromtes Messing



.29



€ 51,00 - M

### Supporto 120 mm

Bracket 120 mm / Support 120 mm / Halter 120 mm

**52811.29**

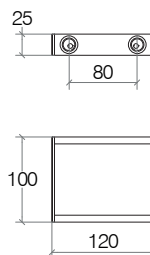

**Ottone cromato**  
Chromed brass  
Laiton chromé  
Verchromtes Messing



.29



€ 54,00 - M

### Supporto 204 mm

Bracket 204 mm / Support 204 mm / Halter 204 mm

**52812.29**

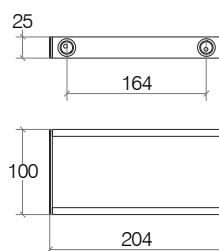

**Ottone cromato**  
Chromed brass  
Laiton chromé  
Verchromtes Messing



.29



€ 64,00 - M

## Skuara

### Portasalvietta / porta accessori 300 mm

Towel holder accessories bar 300 mm / Porte-serviettes support pour accessoires (à équiper) 300 mm  
Handtuchhalter Halter für Accessoires 300 mm

**52813.29**

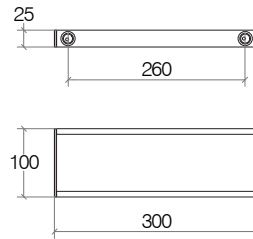

Ottone cromato  
Chromed brass  
Laiton chromé  
Verchromtes Messing



.29



€ 72,00 - M

### Portasalvietta / porta accessori 400 mm

Towel holder accessories bar 400 mm / Porte-serviettes support pour accessoires (à équiper) 400 mm  
Handtuchhalter Halter für Accessoires 400 mm

**52814.29**

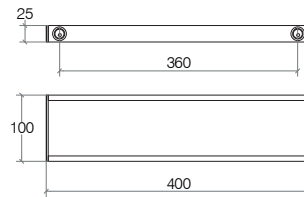

Ottone cromato  
Chromed brass  
Laiton chromé  
Verchromtes Messing



.29



€ 81,00 - M

### Portasalvietta / porta accessori 500 mm

Towel holder accessories bar 500 mm / Porte-serviettes support pour accessoires (à équiper) 500 mm  
Handtuchhalter Halter für Accessoires 500 mm

**52815.29**

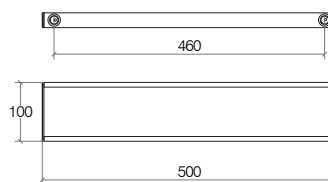

Ottone cromato  
Chromed brass  
Laiton chromé  
Verchromtes Messing



.29



€ 98,00 - M

**Portasalvietta / porta accessori 600 mm**

**52816.29**

Towel holder accessories bar 600 mm / Porte-serviettes support pour accessoires (à équiper) 600 mm  
Handtuchhalter Halter für Accessoires 600 mm

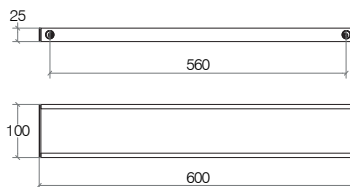

**Ottone cromato**  
Chromed brass  
Laiton chromé  
Verchromtes Messing



.29



€ 105,00 - M

**Portasalvietta / porta accessori 800 mm**

**52818.29**

Towel holder accessories bar 800 mm / Porte-serviettes support pour accessoires (à équiper) 800 mm  
Handtuchhalter Halter für Accessoires 800 mm

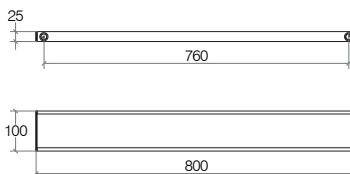

**Ottone cromato**  
Chromed brass  
Laiton chromé  
Verchromtes Messing



.29



€ 125,00 - M

**Mensola vetro satinato 400 mm**

**52834.29**

Satinated glass shelf 400 mm / Tablette en verre satiné 400 mm / Glasablage 400 mm

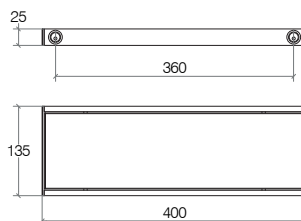

**Ottone cromato**  
Chromed brass  
Laiton chromé  
Verchromtes Messing



.29



€ 119,00 - M

## Skuara

### Mensola vetro satinato 600 mm

Satinated glass shelf 600 mm / Tablette en verre satiné 600 mm / Glasablage 600 mm

52836.29

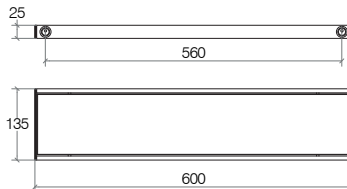

Ottone cromato  
Chromed brass  
Laiton chromé  
Verchromtes Messing



.29



€ 134,00 - M

### Griglia 300 mm

Shelf grid 300 mm / Tablette 300 mm / Ablage 300 mm

52843.29

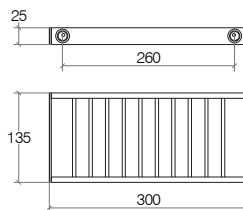

Ottone cromato  
Chromed brass  
Laiton chromé  
Verchromtes Messing



.29



€ 99,00 - M

### Griglia 400 mm

Shelf grid 400 mm / Tablette 400 mm / Ablage 400 mm

52844.29

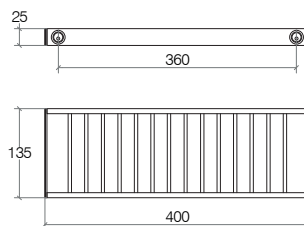

Ottone cromato  
Chromed brass  
Laiton chromé  
Verchromtes Messing



.29



€ 119,00 - M



## Skuara

### Griglia con portasalviette 600 mm

**52867.29**

Shelf with towel rail 600 mm / Rack porte-serviettes 600 mm avec barre / Ablage mit Handtuchhalter 600 mmschwenkbar

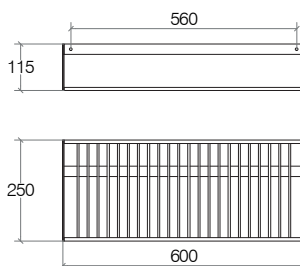

Ottone cromato  
Chromed brass  
Laiton chromé  
Verchromtes Messing



.29



€ 243,00 - M

### Portascopino, abbinabile con supporto minimo 100 mm

**52805.09.29**

Toilet brush, matching with bracket minimum size 100 mm / Porte-balai, compatible avec support minimum 100 mm  
Toilettenbürstengarnitur verwendbar mit Halter Minimum 100 mm

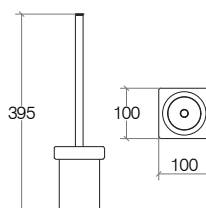

Ceramica  
Ceramic  
Céramique  
Keramik



.09.29



€ 54,00

### Portascopino, abbinabile con supporto minimo 100 mm

**52805.29**

Toilet brush, matching with bracket minimum size 100 mm / Porte-balai, compatible avec support minimum 100 mm  
Toilettenbürstengarnitur verwendbar mit Halter Minimum 100 mm

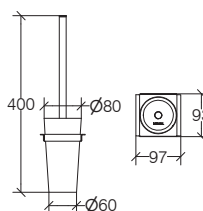

Acciaio inox lucido  
Polished stainless steel  
Acier inoxydable brillant  
Glänzer Edelstahl



.29

€ 68,00

## Skuara

### Bicchieri, abbinabile con supporto minimo 80 mm

52801.09

Tumbler, matching with bracket min size 80 mm / Verre, compatible avec support min 80 mm  
Becher verwendbar mit Halter Min 80 mm

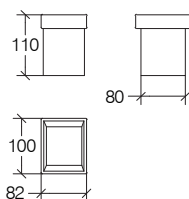

Ceramica  
Ceramic  
Céramique  
Keramik



.09



€ 25,00

### Bicchieri, abbinabile con supporto minimo 80 mm

52801.29

Tumbler, matching with bracket min size 80 mm / Verre, compatible avec support min 80 mm  
Becher verwendbar mit Halter Min 80 mm

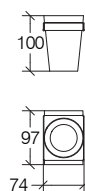

Acciaio inox lucido  
Polished stainless steel  
Acier inoxydable brillant  
Poliert Edelstahl



.29

€ 31,00

### Vaschetta portasapone, abbinabile con supporto minimo 120 mm

52802.09

Soap dish, matching with bracket minimum size 120 mm / Porte-savon, compatible avec support minimum 120 mm  
Seifenablage verwendbar mit Halter Minimum 120 mm

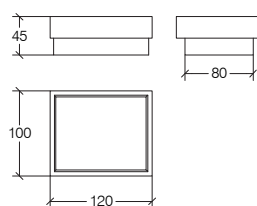

Ceramica  
Ceramic  
Céramique  
Keramik



.09



€ 20,00

### Vaschetta portasapone, abbinabile con supporto minimo 120 mm

52802.29

Soap dish, matching with bracket minimum size 120 mm / Porte-savon, compatible avec support minimum 120 mm  
Seifenablage verwendbar mit Halter Minimum 120 mm

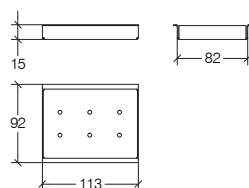

Acciaio inox lucido  
Polished stainless steel  
Acier inoxydable brillant  
Poliert Edelstahl



.29



€ 20,00

## Skuara

### Vaschetta portasapone, abbinabile con supporto minimo 200 mm

**52803.09**

Soap dish, matching with bracket minimum size 200 mm / Porte-savon, compatible avec support minimum 200 mm  
Seifenablage verwendbar mit Halter Minimum 200 mm

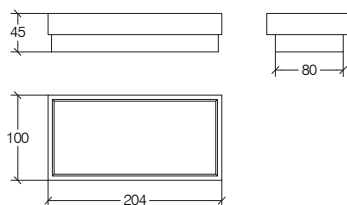

**Ceramica**  
Ceramic  
Céramique  
Keramik



.09



€ 28,00

### Vaschetta portasapone, abbinabile con supporto minimo 200 mm

**52803.29**

Soap dish, matching with bracket minimum size 200 mm / Porte-savon, compatible avec support minimum 200 mm  
Seifenablage verwendbar mit Halter Minimum 200 mm

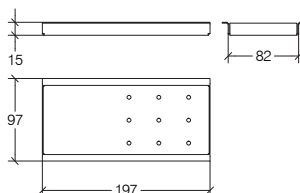

**Acciaio inox lucido**  
Polished stainless steel  
Acier inoxydable brillant  
Poliert Edelstahl



.29



€ 28,00

### Dosasapone 300 ml, abbinabile con supporto minimo 80 mm

**52804.09.29**

Soap dispenser 300 ml, matching with bracket size 80 mm / Distributeur savon liquide 300 ml, compatible avec support 80 mm  
Seifenspender 300 ml, verwendbar mit Halter Minimum 80 mm

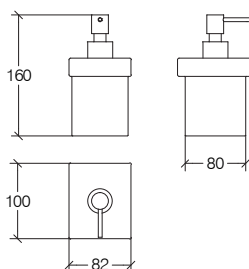

**Ceramica**  
Ceramic  
Céramique  
Keramik



.09.29



€ 49,00

### Dosasapone 350 ml, abbinabile con supporto minimo 80 mm

**52804.29**

Soap dispenser 350 ml, matching with bracket size 80 mm / Distributeur savon liquide 350 ml, compatible avec support 80 mm  
Seifenspender 350 ml, verwendbar mit Halter Minimum 80 mm

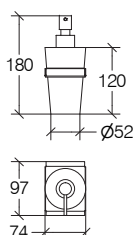

**Acciaio inox lucido**  
Polished stainless steel  
Acier inoxydable brillant  
Poliert Edelstahl



.29

€ 57,00



## Duemila

### Accessori

Accessories / Accessoires / Accessoires

#### IT

##### **Duemila:**

esattamente come la generazione dei millennials.

Snella, semplice, funzionale per quel che basta. Coetanea di coloro che, facendo spesso di necessità virtù, hanno scelto di essere cittadini del mondo.

Ottone cromato con inserti in vetro o porcellana

Fissaggio con viti a muro o a incollo

#### EN

##### **Duemila:**

*exactly like the generation of millennials.*

*Essentially lean, simple, and functional. The same age as those who, often making a virtue of the necessity, have chosen to be citizens of the world.*

*Chromed brass with glass or porcelain inserts*

*Screwed or glued to the wall*

#### FR

##### **Duemila :**

*comme la génération des millennials.*

*Élancée, simple, fonctionnelle juste ce qu'il faut. De la même génération que ceux qui, souvent par nécessité, ont choisi d'être citoyens du monde. Elle permet le choix du collage ou de la fixation traditionnelle, juste pour agrandir le champ des possibles.*

*Laiton chromé avec accessoires en verre ou en porcelaine*

*Fixation au mur avec vis ou colle*

#### DE

##### **Duemila:**

*genau wie die Generation der Millennials.*

*Schlank, einfach, gerade so funktionell wie nötig. Im gleichen Alter wie jene, die häufig aus der Not eine Tugend machten und entschieden haben, Weltbürger zu werden.*

*Verchromtes Messing mit Einsätzen aus Glas oder Porzellan*

*Wandbefestigung durch Anschrauben oder Kleben*

## Duemila

### Portarotolo

Toilet paper holder / Porte-rouleau / Toilettenpapierhalter

**5504.29**

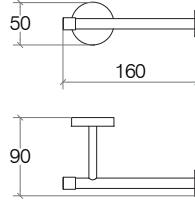

**Ottone cromato**  
Chromed brass  
Laiton chromé  
Verchromtes Messing



non incluso / da ordinare separatamente € 8,00  
not included / to be additionally ordered € 8,00  
non inclus / à commander séparément € 8,00  
Nicht Enthalten / Separat Bestellen € 8,00

ADS.02.UNI

€ 33,00 - S

### Portarotolo

Toilet paper holder / Porte-rouleau / Toilettenpapierhalter

**5508.29**

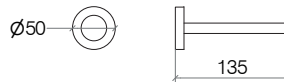

**Ottone cromato**  
Chromed brass  
Laiton chromé  
Verchromtes Messing



non incluso / da ordinare separatamente € 8,00  
not included / to be additionally ordered € 8,00  
non inclus / à commander séparément € 8,00  
Nicht Enthalten / Separat Bestellen € 8,00

ADS.02.UNI

€ 28,00 - S

### Portarotolo doppio

Double toilet paper holder / Porte-rouleau double / Toilettenpapierhalter doppelt

**5505.29**

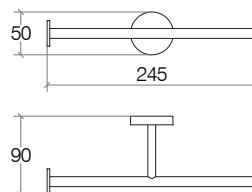

**Ottone cromato**  
Chromed brass  
Laiton chromé  
Verchromtes Messing



non incluso / da ordinare separatamente € 8,00  
not included / to be additionally ordered € 8,00  
non inclus / à commander séparément € 8,00  
Nicht Enthalten / Separat Bestellen € 8,00

ADS.02.UNI

€ 37,00 - S

## Duemila

### Coppia appendini

2 Hooks / Jeu de 2 patères / Paar Hacken

5507.29

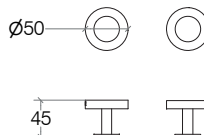

**Ottone cromato**  
Chromed brass  
Laiton chromé  
Verchromtes Messing



.29



ADS.02.UNI

non incluso / da ordinare separatamente € 8,00  
not included / to be additionally ordered € 8,00  
non inclus / à commander séparément € 8,00  
Nicht Enthalten / Separat Bestellen € 8,00

€ 36,00 - S

### Portasalvietta 300 mm

Towel rail 300 mm / Porte-serviettes 300 mm / Handtuchhalter 300 mm

5511.29

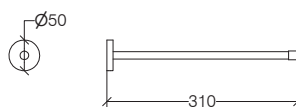

**Ottone cromato**  
Chromed brass  
Laiton chromé  
Verchromtes Messing



.29



ADS.02.UNI

non incluso / da ordinare separatamente € 8,00  
not included / to be additionally ordered € 8,00  
non inclus / à commander séparément € 8,00  
Nicht Enthalten / Separat Bestellen € 8,00

€ 33,00 - S

### Anello portasalvietta

Towel ring / Anneau porte-serviettes / Handtuchring

5509.29

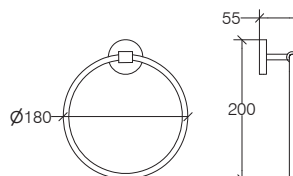

**Ottone cromato**  
Chromed brass  
Laiton chromé  
Verchromtes Messing



.29



ADS.02.UNI

non incluso / da ordinare separatamente € 8,00  
not included / to be additionally ordered € 8,00  
non inclus / à commander séparément € 8,00  
Nicht Enthalten / Separat Bestellen € 8,00

€ 37,00 - S

## Duemila

### Portasalvietta 400 mm

Towel rail 400 mm / Porte-serviettes 400 mm / Handtuchhalter 400 mm

5512.29

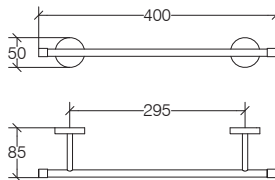

Ottone cromato  
Chromed brass  
Laiton chromé  
Verchromtes Messing



.29



ADS.02.UNI

non incluso / da ordinare separatamente € 8,00  
not included / to be additionally ordered € 8,00  
non inclus / à commander séparément € 8,00  
Nicht Enthalten / Separat Bestellen € 8,00

€ 49,00 - S

### Portasalvietta 500 mm

Towel rail 500 mm / Porte-serviettes 500 mm / Handtuchhalter 500 mm

5513.29

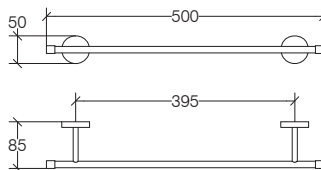

Ottone cromato  
Chromed brass  
Laiton chromé  
Verchromtes Messing



.29



ADS.02.UNI

non incluso / da ordinare separatamente € 8,00  
not included / to be additionally ordered € 8,00  
non inclus / à commander séparément € 8,00  
Nicht Enthalten / Separat Bestellen € 8,00

€ 55,00 - S

### Portasalvietta 600 mm

Towel rail 600 mm / Porte-serviettes 600 mm / Handtuchhalter 600 mm

5514.29

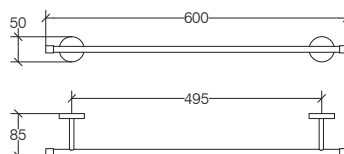

Ottone cromato  
Chromed brass  
Laiton chromé  
Verchromtes Messing



.29



ADS.02.UNI

non incluso / da ordinare separatamente € 8,00  
not included / to be additionally ordered € 8,00  
non inclus / à commander séparément € 8,00  
Nicht Enthalten / Separat Bestellen € 8,00

€ 58,00 - S



## Duemila

### Portasalviette doppio snodato

5517.29

Double jointed towel rail / Porte-serviettes articulé double / Doppelhandtuchhalter schwenkbar

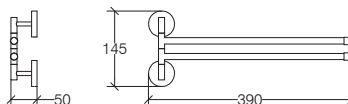

**Ottone cromato**  
Chromed brass  
Laiton chromé  
Verchromtes Messing



.29



ADS.02.UNI

non incluso / da ordinare separatamente € 8,00  
not included / to be additionally ordered € 8,00  
non inclus / à commander séparément € 8,00  
Nicht Enthalten / Separat Bestellen € 8,00

€ 70,00 - S

### Supporto singolo

55001.29

Single holder / Support individuel / Halter lose

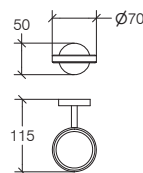

**Ottone cromato**  
Chromed brass  
Laiton chromé  
Verchromtes Messing



.29



ADS.02.UNI

non incluso / da ordinare separatamente € 8,00  
not included / to be additionally ordered € 8,00  
non inclus / à commander séparément € 8,00  
Nicht Enthalten / Separat Bestellen € 8,00

€ 27,00 - S

### Supporto doppio

55002.29

Double holder / Support double / Halter doppelt

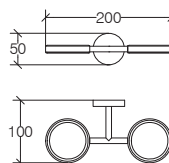

**Ottone cromato**  
Chromed brass  
Laiton chromé  
Verchromtes Messing



.29



ADS.02.UNI

non incluso / da ordinare separatamente € 8,00  
not included / to be additionally ordered € 8,00  
non inclus / à commander séparément € 8,00  
Nicht Enthalten / Separat Bestellen € 8,00

€ 33,00 - S

## Duemila

### Bicchiere

Tumbler / Verre / Becher

**55003.nn**

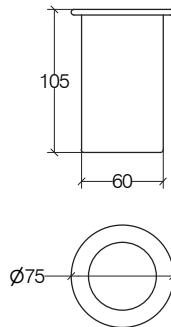

Porcellana  
Porcelaine  
Porcelaine  
Porzellan



.09

Vetro acidato  
Etched glass  
Verre dépoli  
Geätztes Glas



.81

€ 16,00

### Portasapone

Soap dish / Porte-savon / Seifenschale

**55004.nn**

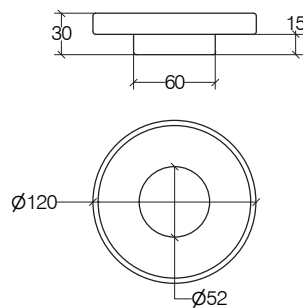

Porcellana  
Porcelaine  
Porcelaine  
Porzellan



.09

Vetro acidato  
Etched glass  
Verre dépoli  
Geätztes Glas



.81

€ 16,00

### Griglietta in silicone antiscivolo per Art. 55004 (20 pezzi assortiti in 4 colori)

20 grip grids for soap dish 55004 / Grille en silicone 20 picks pour porte-savon 55004 / 20 Einlagen für Seifenschale 55004

**5200.nn**

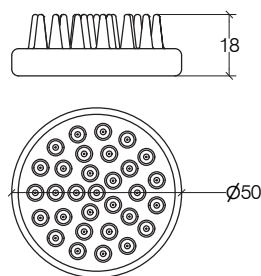

Silicone  
Silicon  
Silicone  
Silikon



.09



.15



.16



.17

€ 38,00

### Dosapone 200 ml

Soap dispenser 200 ml / Distributeur savon liquide 200 ml / Seifenspender 200 ml

**55006.nn**

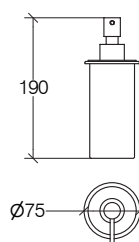

Porcellana  
Porcelaine  
Porcelaine  
Porzellan



.09



.09.22

Vetro acidato  
Etched glass  
Verre dépoli  
Geätztes Glas



.81



.81.22

€ 40,00

**Duemila**

**Dosapone a parete 200 ml**

Wall soap dispenser 200 ml / Distributeur savon liquide mural 200 ml / Wandseifenspender 200 ml

**55032.nn**

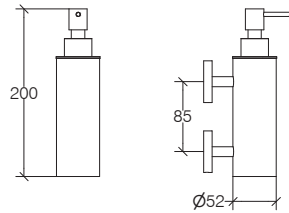

**Ottone cromato**  
 Chromed brass  
 Laiton chromé  
 Verchromtes Messing



.29



€ 70,00 - S

**Supporto portascopino a parete**

Wall toilet brush holder / Support porte-balai mural / Halter lose für Toilettenbürsten am Wand

**55061.29**

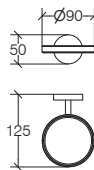

**Ottone cromato**  
 Chromed brass  
 Laiton chromé  
 Verchromtes Messing



.29



€ 33,00 - S

**Portascopino**

Toilet brush / Porte-balai / Toilettenbürstengarnitur

**55062.nn**

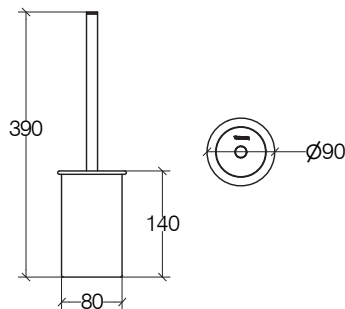

**Vetro acidato**  
 Etched glass  
 Verre dépoli  
 Geätztes Glas

**Porcellana**  
 Porcelaine  
 Porcelaine  
 Porzellan



.81



.81.22



.09



.09.22

€ 41,00

## Duemila

### Coppia supporti mensola

Shelf wall bearing (1 pair) / Paire de supports pour tablette / Paar Halter für Ablage

**5526.29**

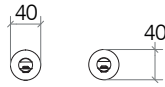

Ottone cromato  
Chromed brass  
Laiton chromé  
Verchromtes Messing



.29



€ 38,00 - S

### Mensola vetro temperato 392 mm

Glass shelf 392 mm / Étagère en verre 392 m / Glasablage 392 mm

**5276.81**

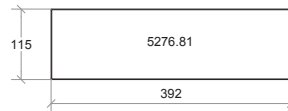

8



Vetro acidato  
Etched glass  
Verre dépoli  
Geätztes Glas

€ 30,00

### Mensola vetro temperato 492 mm

Glass shelf 492 mm / Étagère en verre 492 m / Glasablage 492 mm

**5277.81**

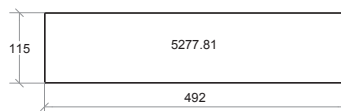

8



Vetro acidato  
Etched glass  
Verre dépoli  
Geätztes Glas

€ 33,00

### Mensola vetro temperato 592 mm

Glass shelf 592 mm / Étagère en verre 592 m / Glasablage 592 mm

**5278.81**

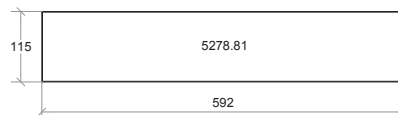

8



Vetro acidato  
Etched glass  
Verre dépoli  
Geätztes Glas

€ 36,00

### Mensola vetro temperato 792 mm

Glass shelf 792 mm / Étagère en verre 792 m / Glasablage 792 mm

**5279.81**

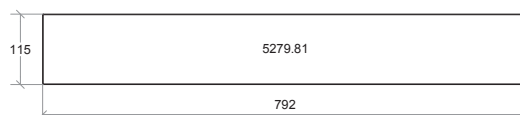

8



Vetro acidato  
Etched glass  
Verre dépoli  
Geätztes Glas

€ 43,00

**TA DUEMILA FIX**

**5512.29**  
**Portasalviette 400 mm**

Towel rail 400 mm / Porte-serviettes 400 mm / Handtuchhalter 400 mm

**Ottone cromato**  
 Chromed brass  
 Laiton chromé  
 Verchromtes Messing

**5507.29**  
**Coppia appendini**

2 Hooks / Jeu de 2 patères / Paar Hacken

**5504.29**  
**Portarotolo**

Toilet paper holder / Porte-rouleau / Toilettenpapierhalter

**55061.29+55062.09**  
**Portascopino**

Towel brush / Porte-balai / Toilettenbürstengarnitur

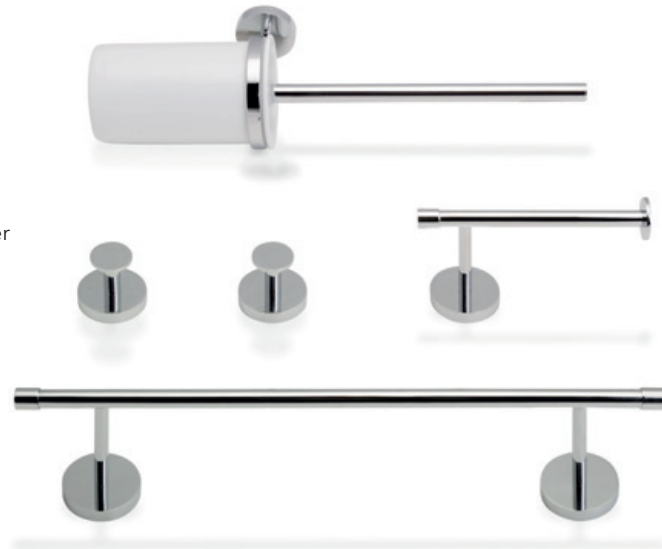

€ 180,00 - S

**TA DUEMILA FIX BIS**

**5512.29**  
**Portasalviette 400 mm**

Towel rail 400 mm / Porte-serviettes 400 mm / Handtuchhalter 400 mm

**Ottone cromato**  
 Chromed brass  
 Laiton chromé  
 Verchromtes Messing

**5507.29**  
**Coppia appendini**

2 Hooks / Jeu de 2 patères / Paar Hacken

**5504.29**  
**Portarotolo**

Toilet paper holder / Porte-rouleau / Toilettenpapierhalter

**50042.29**  
**Portascopino**

Towel brush / Porte-balai / Toilettenbürstengarnitur

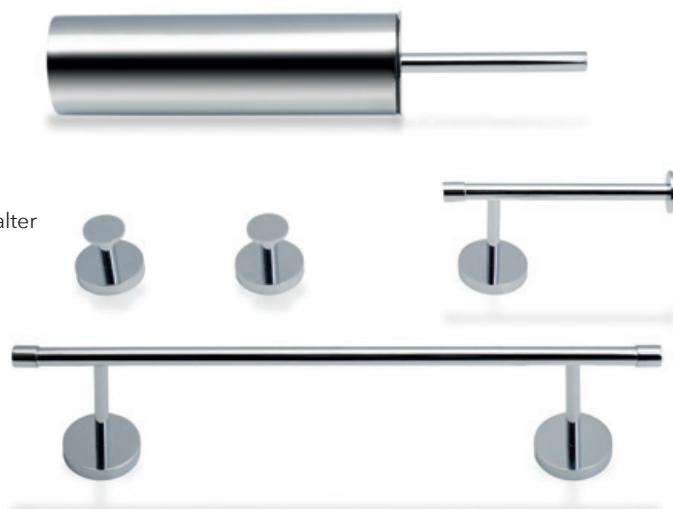

€ 189,00 - S



## Picola

### Accessori

Accessories / Accessoires / Accessoires

#### IT

##### Piccola:

piccolina, l'ultima nata in famiglia, quella che gode della simpatia e delle attenzioni di tutti gli altri membri.

Una serie discreta, amata in particolar modo dagli architetti. Non "ruba il palcoscenico", ma lascia spazio alle velleità architettoniche di chi progetta la casa e il bagno.

Ottone cromato con inserti in vetro o porcellana

Fissaggio con viti a muro

#### EN

##### Piccola:

*small, the baby of the family, the one who enjoys the sympathy and attention of all the other members.*

*A discreet range, loved especially by architects. It does not "steal the stage", but leaves room for the architectural ambitions of those who design the house and the bathroom.*

*Chromed brass with glass or porcelain inserts*

*Screwed to the wall*

#### FR

##### Piccola :

*petite fille, la dernière arrivée dans la famille, celle qui bénéficie de la sympathie et de l'attention de tous les autres membres.*

*Une série discrète, particulièrement appréciée des architectes. Elle ne « vole pas la vedette », mais laisse place aux ambitions architecturales de ceux qui décorent les intérieurs et les salles de bains.*

*Laiton chromé avec accessoires en verre ou en porcelaine*

*Fixation au mur avec vis*

#### DE

##### Piccola:

*die Kleine, die Letztgeborene der Familie, jene, die die Zuneigung und Aufmerksamkeit aller anderen Familienmitglieder genießt.*

*Eine dezente Serie, die besonders von den Architekten geliebt wird. Sie "stiehlt nicht die Schau", sondern lässt den architektonischen Ambitionen dessen Raum, der das Haus und das Bad entwirft.*

*Verchromtes Messing mit Einsätzen aus Glas oder Porzellan*

*Wandbefestigung mit Schrauben*

## Piccola

### Portarotolo

Toilet paper holder / Porte-rouleau / Toilettenpapierhalter

**5254.29**



**Ottone cromato**  
Chromed brass  
Laiton chromé  
Verchromtes Messing



.29



€ 29,00 - S

### Portarotolo

Toilet paper holder / Porte-rouleau / Toilettenpapierhalter

**52535.29**

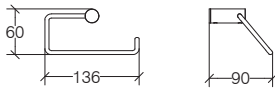

**Ottone cromato**  
Chromed brass  
Laiton chromé  
Verchromtes Messing



.29



€ 37,00 - S

### Portarotolo con riserva

Toilet paper holder with reserve / Porte-rouleau réserve / Toilettenpapier Ersatzrollenhalter

**5255.29**

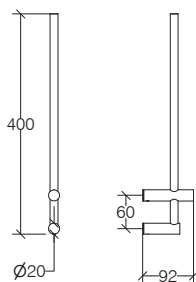

**Ottone cromato**  
Chromed brass  
Laiton chromé  
Verchromtes Messing



.29



€ 50,00 - S

### Coppia appendini

2 Hooks / Jeu de 2 patères / Paar Hacken

**5258.29**

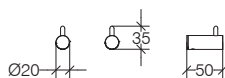

**Ottone cromato**  
Chromed brass  
Laiton chromé  
Verchromtes Messing



.29



€ 29,00 - S



**Piccola**

**Anello portasalviette**

Towel ring / Anneau porte-serviettes / Handtuchring

**5259.29**

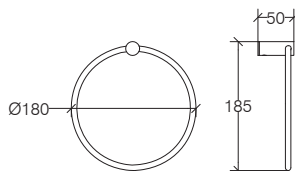

**Ottone cromato**  
 Chromed brass  
 Laiton chromé  
 Verchromtes Messing



.29



€ 38,00 - S

**Portasalviette 400 mm**

Towel rail 400 mm / Porte-serviettes 400 mm / Handtuchhalter 400 mm

**5260.29**

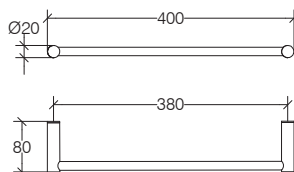

**Ottone cromato**  
 Chromed brass  
 Laiton chromé  
 Verchromtes Messing



.29



€ 54,00 - S

**Portasalviette 600 mm**

Towel rail 600 mm / Porte-serviettes 600 mm / Handtuchhalter 600 mm

**5262.29**

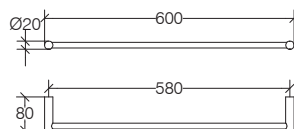

**Ottone cromato**  
 Chromed brass  
 Laiton chromé  
 Verchromtes Messing



.29



€ 57,00 - S

## Piccola

### Portasalviette doppio

Double towel rail / Porte-serviettes double / Handtuchhalter doppelt

**5264.29**

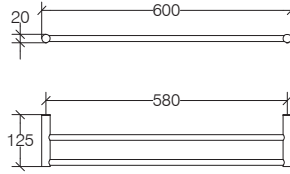

**Ottone cromato**  
Chromed brass  
Laiton chromé  
Verchromtes Messing



.29



€ 93,00 - S

### Portasalviette doppio snodato

Double jointed towel rail / Porte-serviettes articulé double / Doppelhandtuchhalter schwenkbar

**5265.29**

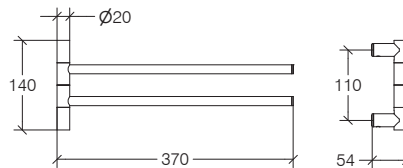

**Ottone cromato**  
Chromed brass  
Laiton chromé  
Verchromtes Messing



.29



€ 82,00 - S

### Supporto singolo

Single holder / Support individuel / Halter lose

**52511.29**

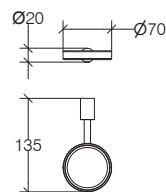

**Ottone cromato**  
Chromed brass  
Laiton chromé  
Verchromtes Messing



.29



€ 31,00 - S

**Picola**

**Supporto portascopino a parete**

Wall toilet brush holder / Support porte-balai mural / Toilettenbürstenhalter

**52561.29**

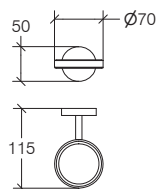

**Ottone cromato**  
 Chromed brass  
 Laiton chromé  
 Verchromtes Messing



**.29**



€ 32,00 - S

**Portascopino**

Toilet brush / Porte-balai / Toilettenbürstengarnitur

**55062.nn**

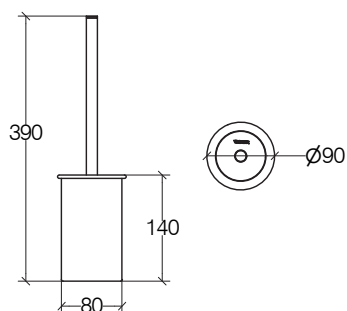

**Vetro acidato**  
 Etched glass  
 Verre dépoli  
 Geätztes Glas

**Porcellana**  
 Porcelaine  
 Porcelaine  
 Porzellan



**.81**



**.81.22**



**.09**



**.09.22**

€ 41,00

**Borchia per serie 'PICOLA'**

Plate for 'PICOLA' range / Plaque murale collection 'PICOLA' / Scheibe für Serie 'PICOLA'

**52510.29**

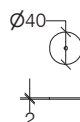

**Ottone cromato**  
 Chromed brass  
 Laiton chromé  
 Verchromtes Messing



**.29**



€ 5,00 - S

## Piccola

### Bicchiere

Tumbler / Verre / Becher

**55003.nn**

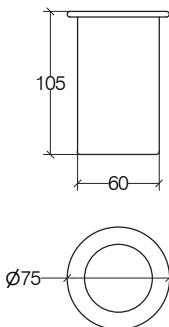

Porcellana  
Porcelaine  
Porcelaine  
Porzellan



.09

Vetro acidato  
Etched glass  
Verre dépoli  
Geätztes Glas



.81

€ 16,00

### Portasapone

Soap dish / Porte-savon / Seifenschale

**55004.nn**

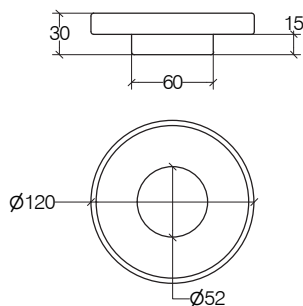

Porcellana  
Porcelaine  
Porcelaine  
Porzellan



.09

Vetro acidato  
Etched glass  
Verre dépoli  
Geätztes Glas



.81

€ 16,00

### Griglietta in silicone antiscivolo per Art. 55004 (20 pezzi assortiti in 4 colori)

20 grip grids for soap dish 55004 / Grille en silicone 20 picks pour porte-savon 55004 / 20 Einlagen für Seifenschale 55004

**5200.nn**

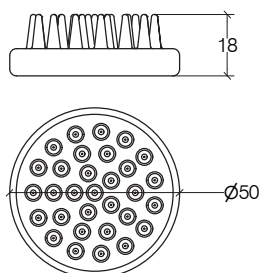

Silicone  
Silicon  
Silicone  
Silikon



.09



.15



.16



.17

€ 38,00

### Dosapapone 200 ml

Soap dispenser 200 ml / Distributeur savon liquide 200 ml / Seifenspender 200 ml

**55006.nn**

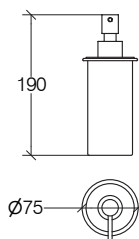

Porcellana  
Porcelaine  
Porcelaine  
Porzellan



.09



.09.22

Vetro acidato  
Etched glass  
Verre dépoli  
Geätztes Glas



.81



.81.22

€ 40,00

**Piccola**

**Coppia supporti mensola**

Shelf wall bearing (1 pair) / Paire de supports pour tablette / Paar Halter für Ablage

**5273.29**

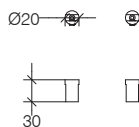

Ottone cromato  
Chromed brass  
Laiton chromé  
Verchromtes Messing



**.29**



€ 26,00 - S

**Mensola vetro temperato 392 mm**

Glass shelf 392 mm / Étagère en verre 392 m / Glasablage 392 mm

**5276.81**

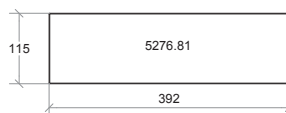

Vetro acidato  
Etched glass  
Verre dépoli  
Geätztes Glas

€ 30,00

**Mensola vetro temperato 492 mm**

Glass shelf 492 mm / Étagère en verre 492 m / Glasablage 492 mm

**5277.81**

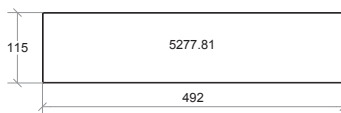

Vetro acidato  
Etched glass  
Verre dépoli  
Geätztes Glas

€ 33,00

**Mensola vetro temperato 592 mm**

Glass shelf 592 mm / Étagère en verre 592 m / Glasablage 592 mm

**5278.81**

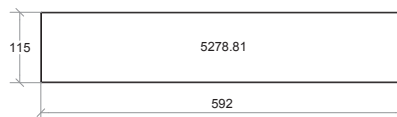

Vetro acidato  
Etched glass  
Verre dépoli  
Geätztes Glas

€ 36,00

**Mensola vetro temperato 792 mm**

Glass shelf 792 mm / Étagère en verre 792 m / Glasablage 792 mm

**5279.81**

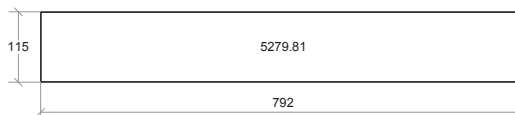

Vetro acidato  
Etched glass  
Verre dépoli  
Geätztes Glas

€ 43,00



## Napie

### Accessori

Accessories / Accessoires / Accessoires

#### IT

##### Napie:

chi ha una grande napia è dotato di un grande naso.

La serie è solida, massiccia e trasmette una sensazione di durata nel tempo. L'oggetto del desiderio di questa collezione, peraltro adattabile anche ad altri ambienti, è la griglia portasalviette dotata di piccoli ganci ad S, da utilizzare per appendere spazzole e guanti per il corpo, Make up Pods, fascie per capelli o altro.

Ottone cromato con inserti in vetro o porcellana o acciaio inox

Fissaggio con viti a muro

#### EN

##### Napie:

those who have a big "napia" have a big nose.

*This range is solid, sturdy and conveys a feeling of durability. The object of desire of this collection, which can also be adapted to other environments, is the towel rail with small S-shaped hooks, to be used to hang body brushes and gloves, make-up pods, hair bands or other items.*

*Chromed brass with glass or porcelain inserts or stainless steel*

*Screwed to the wall*

#### FR

##### Napie :

qui a un gros 'napia', a un gros nez.

*La série est solide, massive et donne une impression de durabilité. L'objet de désir de cette collection, qui peut également être adapté à d'autres contextes, est le porte-serviettes avec ses petits crochets en forme de S - à utiliser pour accrocher des brosses à cheveux, des gants de toilette, le nécessaire à démaquillage et à coiffure.*

*Laiton chromé avec accessoires en verre ou en porcelaine ou acier inox*

*Fixation au mur avec vis*

#### DE

##### Napie:

wer eine große "napia" hat, ist mit einer großen Nase gesegnet.

*Die Serie ist solide, massiv und vermittelt das Gefühl, die Zeit zu überdauern. Bei dieser Kollektion ist das Objekt der Begierde, die sich im Übrigen auch an andere Umgebungen anpassen lässt, das Handtuchgitter mit kleinen s-förmigen Haken, die verwendet werden, um Bürsten und Körperhandschuhe, Make-up-Pads, Haarbänder oder Anderes aufzuhängen.*

*Messing verchromt mit Einsätzen aus Glas oder Porzellan aus Edelstahl*

*Wandbefestigung mit Schrauben*

## Napie

### Portarotolo

Toilet paper holder / Porte-rouleau / Toilettenpapierhalter

**53061.29**

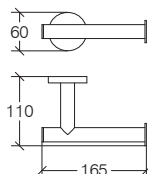

**Ottone cromato**  
Chromed brass  
Laiton chromé  
Verchromtes Messing



.29



non incluso / da ordinare separatamente € 8,00  
not included / to be additionally ordered € 8,00  
non inclus / à commander séparément € 8,00

ADS.02.UNI

Nicht Enthalten / Separat Bestellen € 8,00

€ 41,00 - M

### Portarotolo coperto

Toilet paper holder with lid / Porte-rouleau avec couvercle / Toilettenpapierhalter mit Deckel

**53064.29**

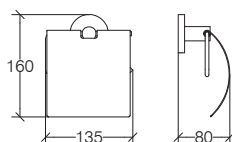

**Ottone cromato**  
Chromed brass  
Laiton chromé  
Verchromtes Messing



.29



€ 58,00 - M

### Portarotolo con riserva

Toilet paper holder with reserve / Porte-rouleau réserve / Ersatzrollenhalter

**53065.29**

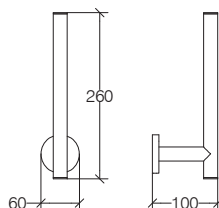

**Ottone cromato**  
Chromed brass  
Laiton chromé  
Verchromtes Messing



.29



non incluso / da ordinare separatamente € 8,00  
not included / to be additionally ordered € 8,00  
non inclus / à commander séparément € 8,00

ADS.02.UNI

Nicht Enthalten / Separat Bestellen € 8,00

€ 46,00 - M

### Coppia appendini

2 Hooks / Jeu de 2 patères / Paar Hacken

**53081.29**

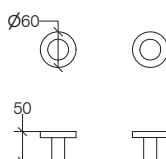

**Ottone cromato**  
Chromed brass  
Laiton chromé  
Verchromtes Messing



.29



non incluso / da ordinare separatamente € 8,00  
not included / to be additionally ordered € 8,00  
non inclus / à commander séparément € 8,00

ADS.02.UNI

Nicht Enthalten / Separat Bestellen € 8,00

€ 46,00 - M



## Napie

### Portasalviette

Towel rail / Porte-serviettes / Handtuchhalter

53111.29

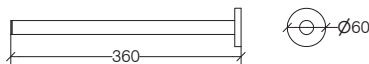

**Ottone cromato**  
Chromed brass  
Laiton chromé  
Verchromtes Messing



.29



€ 43,00 - M

### Portasalviette 400 mm

Towel rail 400 mm / Porte-serviettes 400 mm / Handtuchhalter 400 mm

53114.29

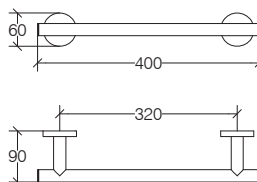

**Ottone cromato**  
Chromed brass  
Laiton chromé  
Verchromtes Messing



.29



ADS.02.UNI

non incluso / da ordinare separatamente € 8,00  
not included / to be additionally ordered € 8,00  
non inclus / à commander séparément € 8,00  
Nicht Enthalten / Separat Bestellen € 8,00

€ 69,00 - M

### Portasalviette 600 mm

Towel rail 600 mm / Porte-serviettes 600 mm / Handtuchhalter 600 mm

53116.29

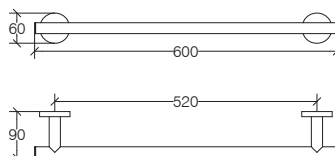

**Ottone cromato**  
Chromed brass  
Laiton chromé  
Verchromtes Messing



.29



ADS.02.UNI

non incluso / da ordinare separatamente € 8,00  
not included / to be additionally ordered € 8,00  
non inclus / à commander séparément € 8,00  
Nicht Enthalten / Separat Bestellen € 8,00

€ 74,00 - M

### Portasalviette doppio snodato

Double jointed towel rail / Porte-serviettes articulé double / Handtuchhalter doppelt schwenkbar

53132.29

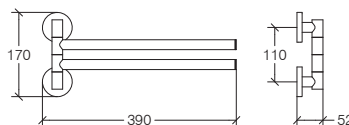

**Ottone cromato**  
Chromed brass  
Laiton chromé  
Verchromtes Messing



.29



€ 105,00 - M

## Napie

### Griglia portasalviette

Towel shelf / Rack porte-serviettes / Handtuchablage

53141.29

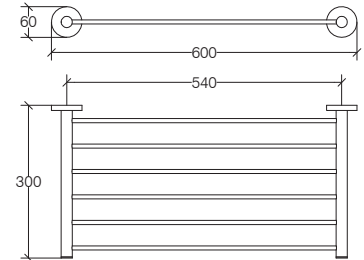

Ottone cromato  
Chromed brass  
Laiton chromé  
Verchromtes Messing



.29



€ 135,00 - M

### Griglia con Portasalviette

Shelf with towel rail / Rack porte-serviettes / Handtuchhalter mit ablage

53151.29

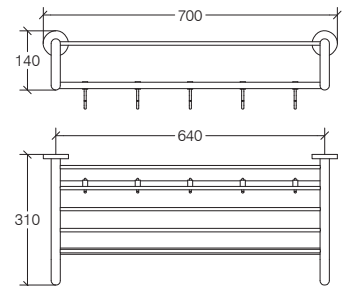

Ottone cromato  
Chromed brass  
Laiton chromé  
Verchromtes Messing



.29



€ 194,00 - M

## Napie

### Supporto singolo

Single holder / Support individuel / Einzelhalter

**53011.29**

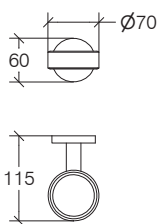

**Ottone cromato**  
 Chromed brass  
 Laiton chromé  
 Verchromtes Messing



.29



€ 33,00 - M

### Supporto portascopino

Toilet brush holder / Support porte-balai / Toilettenbürsten halter

**53066.29**

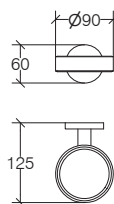

**Ottone cromato**  
 Chromed brass  
 Laiton chromé  
 Verchromtes Messing



.29



€ 36,00 - M

### Portascopino

Toilet brush / Porte-balai / Toilettenbürstengarnitur

**55062.nn**

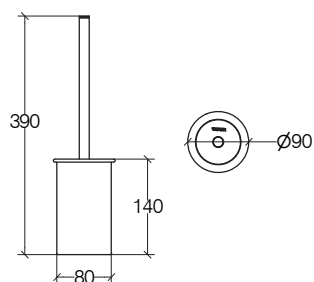

**Vetro acidato**  
 Etched glass  
 Verre dépoli  
 Geätztes Glas



.81 .81.22

**Porcellana**  
 Porcelaine  
 Porcelaine  
 Porzellan



.09 .09.22

€ 41,00

## Napie

### Ghiera per accessori da appoggio serie 'NAPIE'

44070.29

Tabletop ring for 'NAPIE' accessories / Anneau d'appui pour accessoires 'NAPIE' / Tisch Ring für Accessories Serie 'NAPIE'

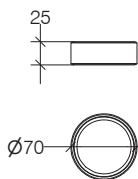

**Ottone cromato**  
Chromed brass  
Laiton chromé  
Verchromtes Messing



.29

€ 13,00 - M

### Bicchiere

Tumbler / Verre / Becher

53020.nn

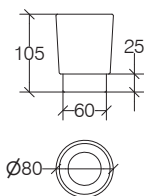

**Porcellana**  
Porcelaine  
Porcelaine  
Porzellan



.09

€ 20,00

**Acciaio lucido**  
Polished stainless steel  
Acier inoxydable brillant  
Glänzer Edelstahl



.29

€ 38,00

**Vetro acidato**  
Etched glass  
Verre dépoli  
Geätztes Glas



.81

€ 15,00

### Portasapone

Soap dish / Porte-savon / Seifenschale

53021.nn

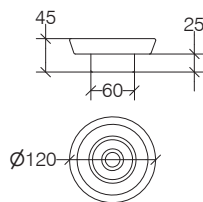

**Porcellana**  
Porcelaine  
Porcelaine  
Porzellan



.09

€ 22,00

**Acciaio lucido**  
Polished stainless steel  
Acier inoxydable brillant  
Glänzer Edelstahl



.29

€ 38,00

**Vetro acidato**  
Etched glass  
Verre dépoli  
Geätztes Glas



.81

€ 17,00

### Dosasapone 300 ml

Soap dispenser 300 ml / Distributeur savon liquide 300 ml / Seifenspender 300 ml

53022.nn

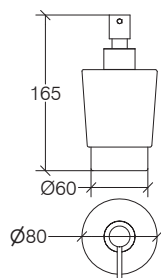

**Porcellana**  
Porcelaine  
Porcelaine  
Porzellan



.09

€ 46,00

**Acciaio lucido**  
Polished stainless steel  
Acier inoxydable brillant  
Glänzer Edelstahl



.29

€ 50,00

**Vetro acidato**  
Etched glass  
Verre dépoli  
Geätztes Glas



.81

€ 42,00

## Napie

### Coppia supporti mensola

Shelf wall bearing (1 pair) / Paire de supports pour étagère / Paar Halter für Ablage

**53153.29**

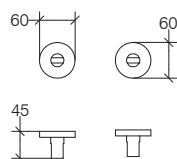

Ottone cromato  
Chromed brass  
Laiton chromé  
Verchromtes Messing



.29



€ 40,00 - M

### Mensola vetro temperato 392 mm

Glass shelf 392 mm / Etagère en verre 392 m / Glasablage 392 mm

**5276.81**

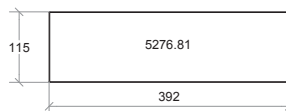

Vetro acidato  
Etched glass  
Verre dépoli  
Geätztes Glas



€ 30,00

### Mensola vetro temperato 492 mm

Glass shelf 492 mm / Etagère en verre 492 m / Glasablage 492 mm

**5277.81**

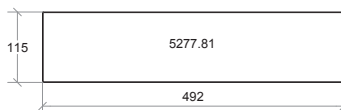

Vetro acidato  
Etched glass  
Verre dépoli  
Geätztes Glas



€ 33,00

### Mensola vetro temperato 592 mm

Glass shelf 592 mm / Etagère en verre 592 m / Glasablage 592 mm

**5278.81**

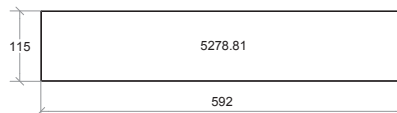

Vetro acidato  
Etched glass  
Verre dépoli  
Geätztes Glas



€ 36,00

### Mensola vetro temperato 792 mm

Glass shelf 792 mm / Etagère en verre 792 m / Glasablage 792 mm

**5279.81**

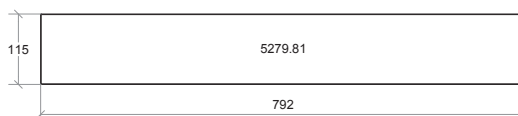

Vetro acidato  
Etched glass  
Verre dépoli  
Geätztes Glas



€ 43,00



## Venessia

### Accessori

Accessories / Accessoires / Accessoires

#### IT

##### Venessia:

Venezia, la nostra adorata città, capoluogo di regione.

Questa serie, proprio come la città della quale porta orgogliosamente il nome, è classica nello stile ma innovativa nei dettagli.

Designer: Royi Frame - Spiral Product Design London

Ottone cromato, oro o bronzo con inserti in porcellana

Fissaggio con viti a muro

#### EN

##### Venessia:

Venice, our beloved city and regional capital.

*This range, just like the city whose name it proudly bears, is classic in style but innovative when it comes to details.*  
Designer: Royi Frame - Spiral Product Design London

*Chromed, gold or bronze brass with porcelain inserts*

*Screwed to the wall*

#### FR

##### Venessia :

Venise, notre ville bien-aimée, capitale régionale.

*Cette série, tout comme la ville dont elle porte fièrement le nom, est de style classique mais innovante dans les détails.*

Designer : Royi Frame - Spiral Product Design - Londres

*Laiton chromé, or ou bronze avec accessoires en porcelaine*

*Fixation au mur avec vis*

#### DE

##### Venessia:

Venedig, unsere bewunderte Stadt, Hauptstadt der Region Venetien.

*Diese Serie ist genau wie die Stadt, deren Namen sie so stolz trägt, klassisch im Stil, aber innovativ in den Details.*  
Designer: Royi Frame - Spiral Product Design London

*Verchromtes, Gold oder Bronze Messing mit Einsätzen aus Porzellan*

*Wandbefestigung mit Schrauben*

## Venessia

### Portarotolo

Toilet paper holder / Porte-rouleau / Toilettenpapierhalter

52908.nn

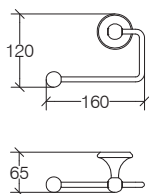

**Ottone cromato**  
Chromed brass  
Laiton chromé  
Verchromtes Messing



.29

**Ottone oro**  
Gold brass  
Laiton or  
Gold Messing



.30

**Ottone bronzo**  
Bronze brass  
Laiton bronze  
Bronze Messing



.35

€ 51,00 - M

€ 77,00 - M



ADS.02.UNI

non incluso / da ordinare separatamente € 8,00  
not included / to be additional y ordered € 8,00  
non inclus / à commander séparément € 8,00  
Nicht Enthalten / Separat Bestellen € 8,00

### Portarotolo coperto

Toilet paper holder with lid / Porte-rouleau avec couvercle / Toilettenpapierhalter mit Deckel

52907.nn

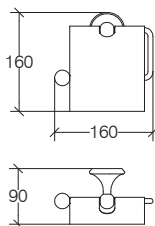

**Ottone cromato**  
Chromed brass  
Laiton chromé  
Verchromtes Messing



.29

**Ottone oro**  
Gold brass  
Laiton or  
Gold Messing



.30

**Ottone bronzo**  
Bronze brass  
Laiton bronze  
Bronze Messing



.35

€ 75,00 - M

€ 106,00 - M



ADS.02.UNI

non incluso / da ordinare separatamente € 8,00  
not included / to be additional y ordered € 8,00  
non inclus / à commander séparément € 8,00  
Nicht Enthalten / Separat Bestellen € 8,00

### Portarotolo con riserva

Toilet paper holder with reserve / Porte-rouleau réserve / Ersatztoilettenpapier

52910.nn

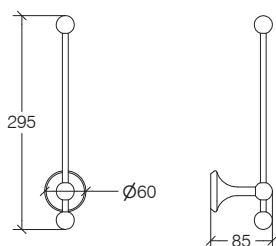

**Ottone cromato**  
Chromed brass  
Laiton chromé  
Verchromtes Messing



.29

**Ottone oro**  
Gold brass  
Laiton or  
Gold Messing



.30

**Ottone bronzo**  
Bronze brass  
Laiton bronze  
Bronze Messing



.35

€ 51,00 - M

€ 75,00 - M





**Appendino**

Hook / Patère / Hacken

**52938.nn**

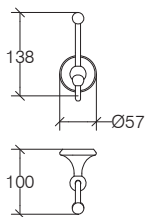

**Ottone cromato**  
Chromed brass  
Laiton chromé  
Verchromtes Messing



**.29**

€ 39,00 - M

**Ottone oro**  
Gold brass  
Laiton or  
Gold Messing



**.30**

€ 61,00 - M

**Ottone bronzo**  
Bronze brass  
Laiton bronze  
Bronze Messing



**.35**



ADS.02.UNI

non incluso / da ordinare separatamente € 8,00  
not included / to be additionally ordered € 8,00  
non inclus / à commander séparément € 8,00  
Nicht Enthalten / Separat Bestellen € 8,00

**Appendino doppio**

Double hook / Patère double / Doppelthacken

**52939.nn**

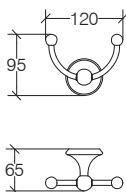

**Ottone cromato**  
Chromed brass  
Laiton chromé  
Verchromtes Messing



**.29**

€ 41,00 - M

**Ottone oro**  
Gold brass  
Laiton or  
Gold Messing



**.30**

€ 64,00 - M

**Ottone bronzo**  
Bronze brass  
Laiton bronze  
Bronze Messing



**.35**



ADS.02.UNI

non incluso / da ordinare separatamente € 8,00  
not included / to be additionally ordered € 8,00  
non inclus / à commander séparément € 8,00  
Nicht Enthalten / Separat Bestellen € 8,00

**Anello portasalviette**

Towel ring / Anneau porte-serviettes / Handtuchring

**52921.nn**

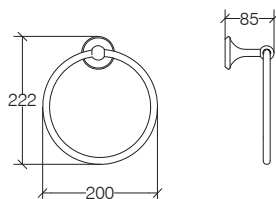

**Ottone cromato**  
Chromed brass  
Laiton chromé  
Verchromtes Messing



**.29**

€ 41,00 - M



ADS.02.UNI

non incluso / da ordinare separatamente € 8,00  
not included / to be additionally ordered € 8,00  
non inclus / à commander séparément € 8,00  
Nicht Enthalten / Separat Bestellen € 8,00

## Venessia

### Portasalviette 457 mm

Towel rail 457 mm / Porte-serviettes 457 mm / Handtuchhalter 457 mm

52914.nn

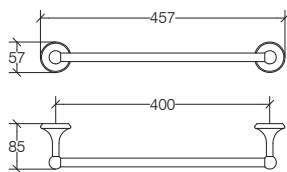

**Ottone cromato**  
Chromed brass  
Laiton chromé  
Verchromtes Messing

**Ottone oro**  
Gold brass  
Laiton or  
Gold Messing

**Ottone bronzo**  
Bronze brass  
Laiton bronze  
Bronze Messing



.29

€ 88,00 - M



.30

€ 114,00 - M



.35



ADS.02.UNI

non incluso / da ordinare separatamente € 8,00  
not included / to be additionally ordered € 8,00  
non inclus / à commander séparément € 8,00  
Nicht Enthalten / Separat Bestellen € 8,00

### Portasalviette 657 mm

Towel rail 657 mm / Porte-serviettes 657 mm / Handtuchhalter 657 mm

52916.nn

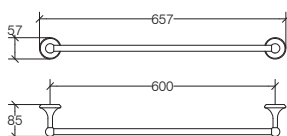

**Ottone cromato**  
Chromed brass  
Laiton chromé  
Verchromtes Messing

**Ottone oro**  
Gold brass  
Laiton or  
Gold Messing

**Ottone bronzo**  
Bronze brass  
Laiton bronze  
Bronze Messing



.29

€ 98,00 - M



.30

€ 124,00 - M



.35



ADS.02.UNI

non incluso / da ordinare separatamente € 8,00  
not included / to be additionally ordered € 8,00  
non inclus / à commander séparément € 8,00  
Nicht Enthalten / Separat Bestellen € 8,00

### Portasalviette doppio 657 mm

Double towel holder 657 mm / Porte-serviettes double 657 mm / Doppelhandtuchhalter 657 mm

52917.nn

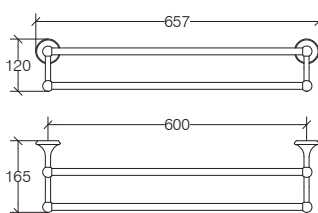

**Ottone cromato**  
Chromed brass  
Laiton chromé  
Verchromtes Messing

**Ottone oro**  
Gold brass  
Laiton or  
Gold Messing

**Ottone bronzo**  
Bronze brass  
Laiton bronze  
Bronze Messing



.29

€ 116,00 - M



.30

€ 152,00 - M



.35



### Portasalviette snodato 340 mm

Jointed towel rail 340 mm / Porte-serviettes articulé 340 mm / Handtuchhalter schwenkbar 340 mm

52920.nn

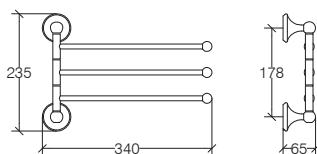

**Ottone cromato**  
Chromed brass  
Laiton chromé  
Verchromtes Messing

**Ottone oro**  
Gold brass  
Laiton or  
Gold Messing

**Ottone bronzo**  
Bronze brass  
Laiton bronze  
Bronze Messing



.29

€ 106,00 - M



.30

€ 166,00 - M



.35



**Portabicchiere con bicchiere in porcellana**

**52901.nn**

Holder with porcelain tumbler / Support avec verre en porcelaine / Halter mit Porzellan Becher

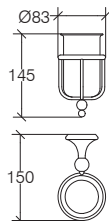

**Ottone cromato**  
Chromed brass  
Laiton chromé  
Verchromtes Messing



**.29**

€ 60,00 - M

**Ottone oro**  
Gold brass  
Laiton or  
Gold Messing



**.30**

€ 94,00 - M

**Ottone bronzo**  
Bronze brass  
Laiton bronze  
Bronze Messing



**.35**



ADS.02.UNI

non incluso / da ordinare separatamente € 8,00  
not included / to be additionally ordered € 8,00  
non inclus / à commander séparément € 8,00  
Nicht Enthalten / Separat Bestellen € 8,00

**Portasapone con piattino in porcellana**

**52902.nn**

Holder with porcelain soap dish / Support avec porte-savon en porcelaine / Halter mit Porzellan Seifenschale

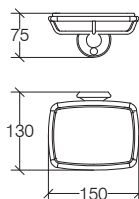

**Ottone cromato**  
Chromed brass  
Laiton chromé  
Verchromtes Messing



**.29**

€ 79,00 - M

**Ottone oro**  
Gold brass  
Laiton or  
Gold Messing



**.30**

€ 106,00 - M

**Ottone bronzo**  
Bronze brass  
Laiton bronze  
Bronze Messing



**.35**



ADS.02.UNI

non incluso / da ordinare separatamente € 8,00  
not included / to be additionally ordered € 8,00  
non inclus / à commander séparément € 8,00  
Nicht Enthalten / Separat Bestellen € 8,00

**Dosasapone a parete 200 ml**

**52904.nn**

Wall soap dispenser 200 ml / Distributeur savon liquide mural 200 ml / Wandseifenspender 200 ml

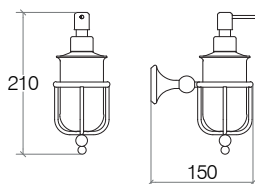

**Ottone cromato**  
Chromed brass  
Laiton chromé  
Verchromtes Messing



**.29**

€ 93,00 - M

**Ottone oro**  
Gold brass  
Laiton or  
Gold Messing



**.30**

€ 126,00 - M

**Ottone bronzo**  
Bronze brass  
Laiton bronze  
Bronze Messing



**.35**



## Venessia

### Portascopino

Towel brush / Porte-balai / Toilettenbürstengarnitur

52906.nn

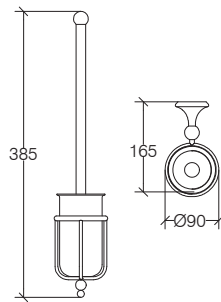

**Ottone cromato**  
Chromed brass  
Laiton chromé  
Verchromtes Messing



.29

€ 93,00 - M

**Ottone oro**  
Gold brass  
Laiton or  
Gold Messing



.30

€ 155,00 - M

**Ottone bronzo**  
Bronze brass  
Laiton bronze  
Bronze Messing



.35



### Griglia con portasalviette

Towel shelf / Rack porte-serviettes / Handtuchablage

52926.nn

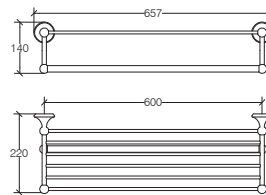

**Ottone cromato**  
Chromed brass  
Laiton chromé  
Verchromtes Messing



.29

€ 171,00 - M

**Ottone oro**  
Gold brass  
Laiton or  
Gold Messing



.30

€ 287,00 - M

**Ottone bronzo**  
Bronze brass  
Laiton bronze  
Bronze Messing



.35



### Traversa vasca

Bathtub bridge / Porte-objets transversal pour baignoire / Badewannenauflage

52924.29

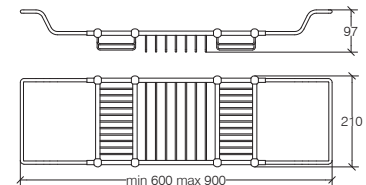

**Ottone cromato**  
Chromed brass  
Laiton chromé  
Verchromtes Messing



.29

€ 151,00 - M

**Coppia supporti mensola**

**52932.29**

Shelf wall bearing (1 pair) / Paire de supports pour étagère / Paar Halter für Ablage

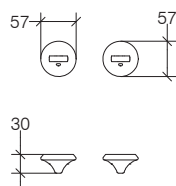

**Ottone cromato**  
Chromed brass  
Laiton chromé  
Verchromtes Messing

**Ottone oro**  
Gold brass  
Laiton or  
Gold Messing

**Ottone bronzo**  
Bronze brass  
Laiton bronze  
Bronze Messing



.29



.30



.35

€ 38,00 - M

€ 59,00 - M



ADS.Q2.UNI

non incluso / da ordinare separatamente € 8,00  
not included / to be additionally ordered € 8,00  
non inclus / à commander séparément € 8,00  
Nicht Enthalten / Separat Bestellen € 8,00

**Mensola vetro temperato 392 mm**

**5276.81**

Glass shelf 392 mm / Étagère en verre 392 m / Glasablage 392 mm

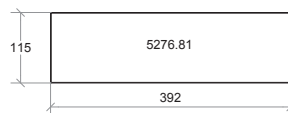

**Vetro acidato**  
Etched glass  
Verre dépoli  
Geätztes Glas

€ 30,00

**Mensola vetro temperato 492 mm**

**5277.81**

Glass shelf 492 mm / Étagère en verre 492 m / Glasablage 492 mm

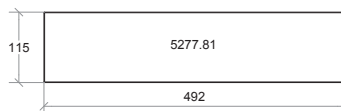

**Vetro acidato**  
Etched glass  
Verre dépoli  
Geätztes Glas

€ 33,00

**Mensola vetro temperato 592 mm**

**5278.81**

Glass shelf 592 mm / Étagère en verre 592 m / Glasablage 592 mm

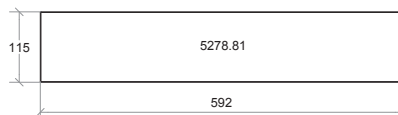

**Vetro acidato**  
Etched glass  
Verre dépoli  
Geätztes Glas

€ 36,00

**Mensola vetro temperato 792 mm**

**5279.81**

Glass shelf 792 mm / Étagère en verre 792 m / Glasablage 792 mm

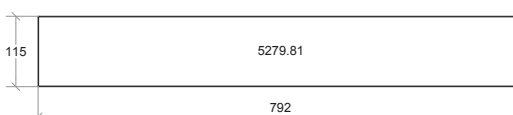

**Vetro acidato**  
Etched glass  
Verre dépoli  
Geätztes Glas

€ 43,00

**Inamorà/Posà**

**Coppia appendini**

2 Hooks / Jeu de 2 patères / Paar Hacken

**49006.91**

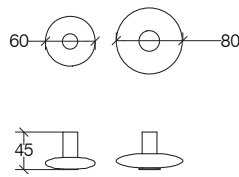

**Ottone spazzolato**  
Brushed brass  
Laiton brossé  
Verchromtes Messing

**Marmo bianco**  
White marble  
Marbre blanc  
Weißer Marmor



€ 100,00 - L

**Coppia appendini**

2 Hooks / Jeu de 2 patères / Paar Hacken

**49006.94**

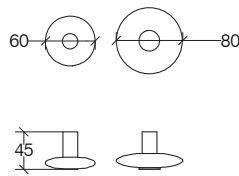

**Ottone spazzolato**  
Brushed brass  
Laiton brossé  
Verchromtes Messing

**Marmo nero**  
Black marble  
Marbre noir  
Schwarz Marmor



€ 100,00 - L

**Appendino doppio**

Double hook / Patère double / Doppelthacken

**5132.nn**

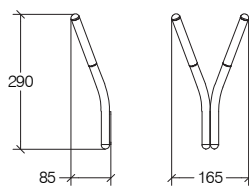

**Metallo verniciato**  
Painted metal  
Métal laqué  
Lackiertes Metall



€ 72,00 - L

## Ricambi / Spare parts / Pièces détachées / Ersatzteile

<b>5152</b>	R2553951	Pompetta completa in ottone cromato per dosatore in vetro e porcellana, Brass chromed pump for glass and porcelaine soap dispenser	<b>20,00</b>
	R22440181	Flacone plastica interno Internal plastic container	<b>4,00</b>
<b>5151</b>	R2250002C	Confezione 2 viti 4x40 + 2 tasselli + chiave - 4 4x40 screws + 4 plugs + key	<b>3,00</b>
<b>5150</b>	R2250002C	Confezione 2 viti 4x40 + 2 tasselli + chiave - 4 4x40 screws + 4 plugs + key	<b>3,00</b>
<b>5144</b>	R2250004C	Confezione 4 viti 4x40 + 4 tasselli - 4 4x40 screws + 4 plugs	<b>3,00</b>
<b>5145</b>	R2250004C	Confezione 4 viti 4x40 + 4 tasselli - 4 4x40 screws + 4 plugs	<b>3,00</b>
<b>5142</b>	R2250004T	Confezione 4 viti 4x40 + 4 tasselli - 4 4x40 screws + 4 plugs	<b>3,00</b>
<b>5143</b>	R2250004C	Confezione 4 viti 4x40 + 4 tasselli - 4 4x40 screws + 4 plugs	<b>3,00</b>
<b>5149DX</b>	R2250004C	Confezione 4 viti 4x40 + 4 tasselli - 4 4x40 screws + 4 plugs	<b>3,00</b>
<b>5149</b>	R2250004C	Confezione 4 viti 4x40 + 4 tasselli - 4 4x40 screws + 4 plugs	<b>3,00</b>
<b>5161</b>	R2400454029	Vite con tappo cromo - Screw with chromed cap	<b>5,00</b>
	R2400454032	Vite con tappo satinato - Screw with satined cap	<b>5,00</b>
<b>5160</b>	R2400454029	Vite con tappo cromo - Screw with chromed cap	<b>5,00</b>
	R2400454032	Vite con tappo satinato - Screw with satined cap	<b>5,00</b>
<b>5164</b>	R2400454029	Vite con tappo cromo - Screw with chromed cap	<b>5,00</b>
	R2400454032	Vite con tappo satinato - Screw with satined cap	<b>5,00</b>
<b>5165</b>	R2400454029	Vite con tappo cromo - Screw with chromed cap	<b>5,00</b>
	R2400454032	Vite con tappo satinato - Screw with satined cap	<b>5,00</b>
<b>5169</b>	R2400454029	Vite con tappo cromo - Screw with chromed cap	<b>5,00</b>
	R2400454032	Vite con tappo satinato - Screw with satined cap	<b>5,00</b>
<b>5170</b>	R2400454029	Vite con tappo cromo - Screw with chromed cap	<b>5,00</b>
	R2400454032	Vite con tappo satinato - Screw with satined cap	<b>5,00</b>
<b>5171</b>	R2400454029	Vite con tappo cromo - Screw with chromed cap	<b>5,00</b>
	R2400454032	Vite con tappo satinato - Screw with satined cap	<b>5,00</b>
<b>5172</b>	R2400454029	Vite con tappo cromo - Screw with chromed cap	<b>5,00</b>
	R2400454032	Vite con tappo satinato - Screw with satined cap	<b>5,00</b>
<b>52894</b>	R2553951	Pompetta completa in ottone cromato per dosatore in vetro e porcellana, Brass chromed pump for glass and porcelaine soap dispenser,	<b>20,00</b>
	R22440021	Tubetto in plastica per pompetta -Venduti pre-Aprile 2015 Plastic tube for pump - Articles sold before April 2015	<b>2,00</b>
	R2244002	Tubetto per pompetta - Articoli venduti dopo Aprile 2015 Plastic tube for pump - Articles sold after April 2015	<b>2,00</b>
<b>52806</b>	R2250002C	Confezione 2 viti 4x40 + 2 tasselli + 1 chiave - 2 screws 4x40 + 2 raw plug + Allan key set	<b>3,00</b>
	R20528084	Kit piastrina + grano serie Skuara - Plate + screw kit Skuara	<b>5,00</b>
	R25528064	Rullo portarotolo SKUARA - Toilet paper SKUARA roll	<b>12,00</b>

## Ricambi / Spare parts / Pièces détachées / Ersatzteile

<b>52807</b>	R2250002C	Confezione 2 viti 4x40 + 2 tasselli + 1 chiave - 2 screws 4x40 + 2 raw plug + Allan key set	<b>3,00</b>
	R20528084	Kit piastrina + grano serie Skuara - Plate + screw kit Skuara	<b>5,00</b>
	R25528064	Rullo portarotolo SKUARA - Toilet paper SKUARA roll	<b>12,00</b>
<b>52853</b>	R2250002C	Confezione 2 viti 4x40 + 2 tasselli + 1 chiave - 2 screws 4x40 + 2 raw plug + Allan key set	<b>3,00</b>
	R20528084	Kit piastrina + grano serie Skuara - Plate + screw kit Skuara	<b>5,00</b>
<b>52813</b>	R2250002C	Confezione 2 viti 4x40 + 2 tasselli + 1 chiave - 2 screws 4x40 + 2 raw plug + Allan key set	<b>3,00</b>
	R20528084	Kit piastrina + grano serie Skuara - Plate + screw kit Skuara	<b>5,00</b>
<b>52814</b>	R2250002C	Confezione 2 viti 4x40 + 2 tasselli + 1 chiave - 2 screws 4x40 + 2 raw plug + Allan key set	<b>3,00</b>
	R20528084	Kit piastrina + grano serie Skuara - Plate + screw kit Skuara	<b>5,00</b>
<b>52815</b>	R2250002C	Confezione 2 viti 4x40 + 2 tasselli + 1 chiave - 2 screws 4x40 + 2 raw plug + Allan key set	<b>3,00</b>
	R20528084	Kit piastrina + grano serie Skuara - Plate + screw kit Skuara	<b>5,00</b>
<b>52816</b>	R2250002C	Confezione 2 viti 4x40 + 2 tasselli + 1 chiave - 2 screws 4x40 + 2 raw plug + Allan key set	<b>3,00</b>
	R20528084	Kit piastrina + grano serie Skuara - Plate + screw kit Skuara	<b>5,00</b>
<b>52818</b>	R2250002C	Confezione 2 viti 4x40 + 2 tasselli + 1 chiave - 2 screws 4x40 + 2 raw plug + Allan key set	<b>3,00</b>
	R20528084	Kit piastrina + grano serie Skuara - Plate + screw kit Skuara	<b>5,00</b>
<b>52808</b>	R2250002C	Confezione 2 viti 4x40 + 2 tasselli + 1 chiave - 2 screws 4x40 + 2 raw plug + Allan key set	<b>3,00</b>
	R20528084	Kit piastrina + grano serie Skuara - Plate + screw kit Skuara	<b>5,00</b>
<b>52810</b>	R2250002C	Confezione 2 viti 4x40 + 2 tasselli + 1 chiave - 2 screws 4x40 + 2 raw plug + Allan key set	<b>3,00</b>
	R20528084	Kit piastrina + grano serie Skuara - Plate + screw kit Skuara	<b>5,00</b>
<b>52811</b>	R2250002C	Confezione 2 viti 4x40 + 2 tasselli + 1 chiave - 2 screws 4x40 + 2 raw plug + Allan key set	<b>3,00</b>
	R20528084	Kit piastrina + grano serie Skuara - Plate + screw kit Skuara	<b>5,00</b>
<b>52812</b>	R2250002C	Confezione 2 viti 4x40 + 2 tasselli + 1 chiave - 2 screws 4x40 + 2 raw plug + Allan key set	<b>3,00</b>
	R20528084	Kit piastrina + grano serie Skuara - Plate + screw kit Skuara	<b>5,00</b>
<b>52834</b>	R2250002C	Confezione 2 viti 4x40 + 2 tasselli + 1 chiave - 2 screws 4x40 + 2 raw plug + Allan key set	<b>3,00</b>
	R20528084	Kit piastrina + grano serie Skuara - Plate + screw kit Skuara	<b>5,00</b>
	5276.81	Mensola vetro temperato spessore 8 mm - Glass shelf thickness 8 mm	<b>30,00</b>
<b>52836</b>	R2250002C	Confezione 2 viti 4x40 + 2 tasselli + 1 chiave - 2 screws 4x40 + 2 raw plug + Allan key set	<b>3,00</b>
	R20528084	Kit piastrina + grano serie Skuara - Plate + screw kit Skuara	<b>5,00</b>
	5278.81	Mensola vetro temperato spessore 8 mm - Glass shelf thickness 8 mm	<b>36,00</b>
<b>52843</b>	R2250002C	Confezione 2 viti 4x40 + 2 tasselli + 1 chiave - 2 screws 4x40 + 2 raw plug + Allan key set	<b>3,00</b>
	R20528084	Kit piastrina + grano serie Skuara - Plate + screw kit Skuara	<b>5,00</b>
<b>52844</b>	R2250002C	Confezione 2 viti 4x40 + 2 tasselli + 1 chiave - 2 screws 4x40 + 2 raw plug + Allan key set	<b>3,00</b>
	R20528084	Kit piastrina + grano serie Skuara - Plate + screw kit Skuara	<b>5,00</b>



## Ricambi / Spare parts / Pièces détachées / Ersatzteile

<b>52801.29</b>	R2252801	Guarnizione - Gasket	<b>3,00</b>
	R23528011	Vaschetta inox - Inox container	<b>12,00</b>
<b>52804.09</b>	R2553951	Pompetta completa in ottone cromato per dosatore in vetro e porcellana. Brass chromed pump for glass and porcelaine soap dispenser.	<b>20,00</b>
	R21528041	Spandisapone ceramica, 300 ml - Soap dispenser ceramic, 300 ml	<b>36,00</b>
	R22440021	Tubetto in plastica per pompetta -Venduti pre-Aprile 2015 Plastic tube for pump - Articles sold before April 2015	<b>2,00</b>
	R2244002	Tubetto per pompetta - Articoli venduti dopo Aprile 2015 Plastic tube for pump - Articles sold after April 2015	<b>2,00</b>
<b>52804.29</b>	R2344090	Pompetta per dosatore inox - Pump for soap dispenser in stainless steel	<b>17,00</b>
	R22440021	Tubetto in plastica per pompetta -Venduti pre-Aprile 2015 Plastic tube for pump - Articles sold before April 2015	<b>2,00</b>
	R2252801	Guarnizione - Gasket	<b>3,00</b>
	R2244002	Tubetto per pompetta - Articoli venduti dopo Aprile 2015 Plastic tube for pump - Articles sold after April 2015	<b>2,00</b>
	R23528011	Vaschetta inox - Inox container	<b>12,00</b>
<b>52805.09</b>	R2250055	Setola scopino - Toilet brush	<b>6,00</b>
	R539329	Manico scopino cromato con ciuffo - Toilet brush with chromed stick	<b>19,00</b>
	R21528051	Porta scopino - Toilet brush holder	<b>29,00</b>
	R2250054	Copriscopino Ø 67 - Toilet brush lid Ø 67	<b>4,00</b>
	R2550069	Manico scopino 300 mm - Toilet brush handle 300 mm	<b>15,00</b>
<b>52805.29</b>	R2250055	Setola scopino - Toilet brush	<b>6,00</b>
	R23528051	Porta scopino - Toilet brush holder	<b>27,00</b>
	R539329	Manico scopino cromato con ciuffo - Toilet brush with chromed stick	<b>19,00</b>
	R2250056	Copri scopino - Toilet brush lid	<b>4,00</b>
	R2550069	Manico scopino 300 mm - Toilet brush handle 300 mm	<b>15,00</b>
	R23528052	Vaschetta inox - Inox container	<b>16,00</b>
	R2252805	Guarnizione scopino d. 73 - 80 mm Toilet brush seal diam. 73-80 mm	<b>3,00</b>
<b>5204</b>	R2250002C	Confezione 2 viti 4x40 + 2 tasselli + 1 chiave - 2 screws 4x40 + 2 raw plug + Allan key set	<b>3,00</b>
	R2500119	Piastrina conica Ø 30 mm - Conical plate Ø 30 mm	<b>3,00</b>
<b>5203</b>	R2250002	Confezione 2 viti 4x40 + 2 tasselli - 2 screws 4x40 + 2 raw plug set	<b>2,00</b>
<b>5205</b>	R2250002C	Confezione 2 viti 4x40 + 2 tasselli + 1 chiave - 2 screws 4x40 + 2 raw plug + Allan key set	<b>3,00</b>
	R2500119	Piastrina conica Ø 30 mm - Conical plate Ø 30 mm	<b>3,00</b>
<b>5208</b>	R2250004C	Confezione 4 viti 4x40 + 4 tasselli +1 chiave - 4 screws 4x40 + 4 raw plug + Allan key set	<b>3,00</b>
	R2500119	Piastrina conica Ø 30 mm - Conical plate Ø 30 mm	<b>3,00</b>
<b>5210</b>	R2250004C	Confezione 4 viti 4x40 + 4 tasselli +1 chiave - 4 screws 4x40 + 4 raw plug + Allan key set	<b>3,00</b>
	R2500119	Piastrina conica Ø 30 mm - Conical plate Ø 30 mm	<b>3,00</b>

## Ricambi / Spare parts / Pièces détachées / Ersatzteile

<b>5211</b>	R2250004C	Confezione 4 viti 4x40 + 4 tasselli +1 chiave - 4 screws 4x40 + 4 raw plug + Allan key set	<b>3,00</b>
	R2500119	Piastrina conica Ø 30 mm - Conical plate Ø 30 mm	<b>3,00</b>
<b>5212</b>	R2250004C	Confezione 4 viti 4x40 + 4 tasselli +1 chiave - 4 screws 4x40 + 4 raw plug + Allan key set	<b>3,00</b>
	R2500119	Piastrina conica Ø 30 mm - Conical plate Ø 30 mm	<b>3,00</b>
<b>5214</b>	R2250004C	Confezione 4 viti 4x40 + 4 tasselli +1 chiave - 4 screws 4x40 + 4 raw plug + Allan key set	<b>3,00</b>
	R2500119	Piastrina conica Ø 30 mm - Conical plate Ø 30 mm	<b>3,00</b>
<b>52152</b>	R2250004C	Confezione 4 viti 4x40 + 4 tasselli +1 chiave - 4 screws 4x40 + 4 raw plug + Allan key set	<b>3,00</b>
	R2500119	Piastrina conica Ø 30 mm - Conical plate Ø 30 mm	<b>3,00</b>
<b>52153</b>	R2250004C	Confezione 4 viti 4x40 + 4 tasselli +1 chiave - 4 screws 4x40 + 4 raw plug + Allan key set	<b>3,00</b>
	R2500119	Piastrina conica Ø 30 mm - Conical plate Ø 30 mm	<b>3,00</b>
	R2255173	Guarnizione in plastica - Plastic gasket	<b>3,00</b>
<b>52011</b>	R2255011	Guarnizione silicone Ø 70 mm - Silicon gasket Ø 70 mm	<b>3,00</b>
	R2250002C	Confezione 2 viti 4x40 + 2 tasselli + 1 chiave - 2 screws 4x40 + 2 raw plug + Allan key set	<b>3,00</b>
	R2500119	Piastrina conica Ø 30 mm - Conical plate Ø 30 mm	<b>3,00</b>
<b>52061</b>	R2255011	Guarnizione silicone Ø 70 mm - Silicon gasket Ø 70 mm	<b>3,00</b>
	R2250002C	Confezione 2 viti 4x40 + 2 tasselli + 1 chiave - 2 screws 4x40 + 2 raw plug + Allan key set	<b>3,00</b>
	R2500119	Piastrina conica Ø 30 mm - Conical plate Ø 30 mm	<b>3,00</b>
<b>5216</b>	R2250004C	Confezione 4 viti 4x40 + 4 tasselli +1 chiave - 4 screws 4x40 + 4 raw plug + Allan key set	<b>3,00</b>
	R2500119	Piastrina conica Ø 30 mm - Conical plate Ø 30 mm	<b>3,00</b>
<b>5234</b>	R2250004C	Confezione 4 viti 4x40 + 4 tasselli +1 chiave - 4 screws 4x40 + 4 raw plug + Allan key set	<b>3,00</b>
	R2500119	Piastrina conica Ø 30 mm - Conical plate Ø 30 mm	<b>3,00</b>
<b>5233</b>	R2250004C	Confezione 4 viti 4x40 + 4 tasselli +1 chiave - 4 screws 4x40 + 4 raw plug + Allan key set	<b>3,00</b>
	R2500119	Piastrina conica Ø 30 mm - Conical plate Ø 30 mm	<b>3,00</b>
<b>5217</b>	R2553951	Pompetta completa in ottone cromato per dosatore in vetro e porcellana, Brass chromed pump for glass and porcelain soap dispenser,	<b>20,00</b>
	R2240402	Flacone in plastica, 180 ml - Plastic dispenser, 180 ml	<b>4,00</b>
	R2250002C	Confezione 2 viti 4x40 + 2 tasselli + 1 chiave - 2 screws 4x40 + 2 raw plug + Allan key set	<b>3,00</b>
	R2500119	Piastrina conica Ø 30 mm - Conical plate Ø 30 mm	<b>3,00</b>
	R2200108	O-ring - O-ring	<b>3,00</b>
	R2244002	Tubetto per pompetta - Articoli venduti dopo Aprile 2015 Plastic tube for pump - Articles sold after April 2015	<b>2,00</b>
	R22440021	Tubetto in plastica per pompetta -Venduti pre-Aprile 2015 Plastic tube for pump - Articles sold before April 2015	<b>2,00</b>
<b>55006</b>	R2553951	Pompetta completa in ottone cromato per dosatore in vetro e porcellana, Brass chromed pump for glass and porcelain soap dispenser,	<b>20,00</b>
	R2652031	Vaso vetro acidato per dosatore, 200 ml - Etched glass soap dispenser, 200 ml	<b>15,00</b>
	R2652032	Vaso porcellana per dosasapone, 200 ml - Porcelaine soap dispenser holder, 200 ml	<b>15,00</b>
	R2244002	Tubetto per pompetta - Articoli venduti dopo Aprile 2015 Plastic tube for pump - Articles sold after April 2015	<b>2,00</b>
	R2255006	Guarnizione in plastica - Plastic gasket	<b>5,00</b>
	R25550061	Ghiera in ottone con guarnizione in plastica - Chromed brass ring with plastic gasket	<b>9,00</b>

## Ricambi / Spare parts / Pièces détachées / Ersatzteile

<b>55062</b>	R2155062	Vaso porta scopino in porcellana - Porcelaine toilet brush holder	<b>20,00</b>
	R2652061	Vaso vetro acidato per porta scopino - Etched glass toilet brush	<b>16,00</b>
	R2250055	Setola scopino - Toilet brush	<b>6,00</b>
	R539329	Manico scopino cromato con ciuffo - Toilet brush with chromed stick	<b>19,00</b>
	R2250054	Copriscopino Ø 67 - Toilet brush lid Ø 67	<b>4,00</b>
	R2550069	Manico scopino 300 mm - Toilet brush handle 300 mm	<b>15,00</b>
<b>5504</b>	R2250002C	Confezione 2 viti 4x40, 2 tasselli, 1 chiave - 2 screws 4x40, 2 raw plug, Allan key set	<b>3,00</b>
	R25001181	Kit piastrina + grano - Plate + screw kit	<b>3,00</b>
<b>5508</b>	R2250002C	Confezione 2 viti 4x40, 2 tasselli, 1 chiave - 2 screws 4x40, 2 raw plug, Allan key set	<b>3,00</b>
	R25001181	Kit piastrina + grano - Plate + screw kit	<b>3,00</b>
<b>5505</b>	R2250002C	Confezione 2 viti 4x40, 2 tasselli, 1 chiave - 2 screws 4x40, 2 raw plug, Allan key set	<b>3,00</b>
	R25001181	Kit piastrina + grano - Plate + screw kit	<b>3,00</b>
<b>5507</b>	R2250004C	Confezione 4 viti 4x4, 4 tasselli, chiave - 4 screws 4x40, 4 raw plug, Allan key set	<b>3,00</b>
	R25001181	Kit piastrina + grano - Plate + screw kit	<b>3,00</b>
<b>5509</b>	R2250002C	Confezione 2 viti 4x40, 2 tasselli, 1 chiave - 2 screws 4x40, 2 raw plug, Allan key set	<b>3,00</b>
	R25001181	Kit piastrina + grano - Plate + screw kit	<b>3,00</b>
<b>5511</b>	R2250002C	Confezione 2 viti 4x40, 2 tasselli, 1 chiave - 2 screws 4x40, 2 raw plug, Allan key set	<b>3,00</b>
	R25001181	Kit piastrina + grano - Plate + screw kit	<b>3,00</b>
<b>5512</b>	R2250004C	Confezione 4 viti 4x4, 4 tasselli, chiave - 4 screws 4x40, 4 raw plug, Allan key set	<b>3,00</b>
	R25001181	Kit piastrina + grano - Plate + screw kit	<b>3,00</b>
<b>5513</b>	R2250004C	Confezione 4 viti 4x4, 4 tasselli, chiave - 4 screws 4x40, 4 raw plug, Allan key set	<b>3,00</b>
	R25001181	Kit piastrina + grano - Plate + screw kit	<b>3,00</b>
<b>5514</b>	R2250004C	Confezione 4 viti 4x4, 4 tasselli, chiave - 4 screws 4x40, 4 raw plug, Allan key set	<b>3,00</b>
	R25001181	Kit piastrina + grano - Plate + screw kit	<b>3,00</b>
<b>5517</b>	R2250004C	Confezione 4 viti 4x4, 4 tasselli, chiave - 4 screws 4x40, 4 raw plug, Allan key set	<b>3,00</b>
	R25001181	Kit piastrina + grano - Plate + screw kit	<b>3,00</b>
<b>55001</b>	R2255011	Guarnizione silicone Ø 70 mm - Silicon gasket Ø 70 mm	<b>3,00</b>
	R2250002C	Confezione 2 viti 4x40, 2 tasselli, 1 chiave - 2 screws 4x40, 2 raw plug, Allan key set	<b>3,00</b>
	R25001181	Kit piastrina + grano - Plate + screw kit	<b>3,00</b>
<b>55002</b>	R2255011	Guarnizione silicone Ø 70 mm - Silicon gasket Ø 70 mm	<b>3,00</b>
	R2250002C	Confezione 2 viti 4x40, 2 tasselli, 1 chiave - 2 screws 4x40, 2 raw plug, Allan key set	<b>3,00</b>
	R25001181	Kit piastrina + grano - Plate + screw kit	<b>3,00</b>

## Ricambi / Spare parts / Pièces détachées / Ersatzteile

55061	R2255011	Guarnizione silicone Ø 70 mm - Silicon gasket Ø 70 mm	3,00
	R2250002C	Confezione 2 viti 4x40, 2 tasselli, 1 chiave - 2 screws 4x40, 2 raw plug, Allan key set	3,00
	R25001181	Kit piastrina + grano - Plate + screw kit	3,00
5526	R2250004C	Confezione 4 viti 4x4, 4 tasselli, chiave -4 screws 4x40, 4 raw plug, Allan key set	3,00
	R25001181	Kit piastrina + grano - Plate + screw kit	3,00
55032	R22440021	Tubetto in plastica per pompetta -Venduti pre-Aprile 2015 Plastic tube for pump - Articles sold before April 2015	2,00
	R2553951	Pompetta completa in ottone cromato per dosatore in vetro e porcellana, Brass chromed pump for glass and porcelain soap dispenser,	20,00
	R2250004C	Confezione 4 viti 4x4, 4 tasselli, chiave -4 screws 4x40, 4 raw plug, Allan key set	3,00
	R25001181	Kit piastrina + grano - Plate + screw kit	3,00
	R2200108	O-ring - O-ring	3,00
	R2240403	Flacone in plastica, 220 ml - Plastic dispenser, 220 ml	4,00
	R2244002	Tubetto per pompetta - Articoli venduti dopo Aprile 2015 Plastic tube for pump - Articles sold after April 2015	2,00
55006	R2553951	Pompetta completa in ottone cromato per dosatore in vetro e porcellana, Brass chromed pump for glass and porcelain soap dispenser,	20,00
	R2652031	Vaso vetro acidato per dosatore, 200 ml - Etched glass soap dispenser, 200 ml	15,00
	R2652032	Vaso porcellana per dosasapone, 200 ml - Porcelaine soap dispenser holder, 200 ml	15,00
	R2244002	Tubetto per pompetta - Articoli venduti dopo Aprile 2015 Plastic tube for pump - Articles sold after April 2015	2,00
	R2255006	Guarnizione in plastica - Plastic gasket	5,00
	R25550061	Ghiera in ottone con guarnizione in plastica - Chromed brass ring with plastic gasket	9,00
55062	R2155062	Vaso porta scopino in porcellana - Porcelaine toilet brush holder	20,00
	R2652061	Vaso vetro acidato per porta scopino - Etched glass toilet brush	16,00
	R2250055	Setola scopino - Toilet brush	6,00
	R539329	Manico scopino cromato con ciuffo - Toilet brush with chromed stick	19,00
	R2250054	Copriscopino Ø 67 - Toilet brush lid Ø 67	4,00
	R2550069	Manico scopino 300 mm - Toilet brush handle 300 mm	15,00
5254	R2250001C	Confezione 1 vite 4x40 + 1 tassello + 1 chiave - 1 screws 4x40 + 1 raw plug + Allan key set	3,00
	R2552532	Kit perno + grano serie Picola - Plate + screw kit Picola	7,00
52535	R2250001C	Confezione 1 vite 4x40 + 1 tassello + 1 chiave - 1 screws 4x40 + 1 raw plug + Allan key set	3,00
	R2552532	Kit perno + grano serie Picola - Plate + screw kit Picola	7,00
5255	R2250002C	Confezione 2 viti 4x40 + 2 tasselli + 1 chiave - 2 screws 4x40 + 2 raw plug + Allan key set	3,00
	R2552532	Kit perno + grano serie Picola - Plate + screw kit Picola	7,00
5258	R2250002C	Confezione 2 viti 4x40 + 2 tasselli + 1 chiave - 2 screws 4x40 + 2 raw plug + Allan key set	3,00
	R2552532	Kit perno + grano serie Picola - Plate + screw kit Picola	7,00
5259	R2250001C	Confezione 1 vite 4x40 + 1 tassello + 1 chiave - 1 screws 4x40 + 1 raw plug + Allan key set	3,00
	R2552532	Kit perno + grano serie Picola - Plate + screw kit Picola	7,00

## Ricambi / Spare parts / Pièces détachées / Ersatzteile

<b>5260</b>	R2250002C	Confezione 2 viti 4x40 + 2 tasselli + 1 chiave - 2 screws 4x40 + 2 raw plug + Allan key set	<b>3,00</b>
	R2552532	Kit perno + grano serie Picola - Plate + screw kit Picola	<b>7,00</b>
<b>5262</b>	R2250002C	Confezione 2 viti 4x40 + 2 tasselli + 1 chiave - 2 screws 4x40 + 2 raw plug + Allan key set	<b>3,00</b>
	R2552532	Kit perno + grano serie Picola - Plate + screw kit Picola	<b>7,00</b>
<b>5264</b>	R2250002C	Confezione 2 viti 4x40 + 2 tasselli + 1 chiave - 2 screws 4x40 + 2 raw plug + Allan key set	<b>3,00</b>
	R2552532	Kit perno + grano serie Picola - Plate + screw kit Picola	<b>7,00</b>
<b>5265</b>	R2250002C	Confezione 2 viti 4x40 + 2 tasselli + 1 chiave - 2 screws 4x40 + 2 raw plug + Allan key set	<b>3,00</b>
	R2552532	Kit perno + grano serie Picola - Plate + screw kit Picola	<b>7,00</b>
<b>52511</b>	R2255011	Guarnizione silicone Ø 70 mm - Silicon gasket Ø 70 mm	<b>3,00</b>
	R2250001C	Confezione 1 vite 4x40 + 1 tassello + 1 chiave - 1 screws 4x40 + 1 raw plug + Allan key set	<b>3,00</b>
	R2552532	Kit perno + grano serie Picola - Plate + screw kit Picola	<b>7,00</b>
<b>52561</b>	R2255061	Guarnizione in silicone Ø 90 mm - Silicon gasket Ø 90 mm	<b>3,00</b>
	R2250001C	Confezione 1 vite 4x40 + 1 tassello + 1 chiave - 1 screws 4x40 + 1 raw plug + Allan key set	<b>3,00</b>
	R2552532	Kit perno + grano serie Picola - Plate + screw kit Picola	<b>7,00</b>
<b>5273</b>	R2250002C	Confezione 2 viti 4x40 + 2 tasselli + 1 chiave - 2 screws 4x40 + 2 raw plug + Allan key set	<b>3,00</b>
	R2552532	Kit perno + grano serie Picola - Plate + screw kit Picola	<b>7,00</b>
<b>55006</b>	R2553951	Pompetta completa in ottone cromato per dosatore in vetro e porcellana, Brass chromed pump for glass and porcelaine soap dispenser,	<b>20,00</b>
	R2652031	Vaso vetro acidato per dosatore, 200 ml - Etched glass soap dispenser, 200 ml	<b>15,00</b>
	R2652032	Vaso porcellana per dosasapone, 200 ml - Porcelaine soap dispenser holder, 200 ml	<b>15,00</b>
	R2244002	Tubetto per pompetta - Articoli venduti dopo Aprile 2015 Plastic tube for pump - Articles sold after April 2015	<b>2,00</b>
	R2255006	Guarnizione in plastica - Plastic gasket	<b>5,00</b>
	R25550061	Ghiera in ottone con guarnizione in plastica - Chromed brass ring with plastic gasket	<b>9,00</b>
<b>55062</b>	R2155062	Vaso porta scopino in porcellana - Porcelaine toilet brush holder	<b>20,00</b>
	R2652061	Vaso vetro acidato per porta scopino - Etched glass toilet brush	<b>16,00</b>
	R2250055	Setola scopino - Toilet brush	<b>6,00</b>
	R539329	Manico scopino cromato con ciuffo - Toilet brush with chromed stick	<b>19,00</b>
	R2250054	Copriscopino Ø 67 - Toilet brush lid Ø 67	<b>4,00</b>
	R2550069	Manico scopino 300 mm - Toilet brush handle 300 mm	<b>15,00</b>
<b>53061</b>	R2250002C	Confezione 2 viti 4x40 + 2 tasselli + 1 chiave - 2 screws 4x40 + 2 raw plug + Allan key set	<b>3,00</b>
	R2500116	Piastrina conica Ø 45 mm - Conical plate Ø 45 mm	<b>3,00</b>
<b>53064</b>	R2250002C	Confezione 2 viti 4x40 + 2 tasselli + 1 chiave - 2 screws 4x40 + 2 raw plug + Allan key set	<b>3,00</b>
	R25530641	Piastrina conica - Conical plate	<b>3,00</b>

## Ricambi / Spare parts / Pièces détachées / Ersatzteile

<b>53065</b>	R2250002C	Confezione 2 viti 4x40 + 2 tasselli + 1 chiave - 2 screws 4x40 + 2 raw plug + Allan key set	<b>3,00</b>
	R2500116	Piastrina conica Ø 45 mm - Conical plate Ø 45 mm	<b>3,00</b>
<b>53081</b>	R2250004C	Confezione 4 viti 4x4, 4 tasselli, chiave -4 screws 4x40, 4 raw plug, Allan key set	<b>3,00</b>
	R2500116	Piastrina conica Ø 45 mm - Conical plate Ø 45 mm	<b>3,00</b>
<b>53111</b>	R2250002C	Confezione 2 viti 4x40 + 2 tasselli + 1 chiave - 2 screws 4x40 + 2 raw plug + Allan key set	<b>3,00</b>
	R2500116	Piastrina conica Ø 45 mm - Conical plate Ø 45 mm	<b>3,00</b>
<b>53114</b>	R2250004C	Confezione 4 viti 4x4, 4 tasselli, chiave -4 screws 4x40, 4 raw plug, Allan key set	<b>3,00</b>
	R2500116	Piastrina conica Ø 45 mm - Conical plate Ø 45 mm	<b>3,00</b>
<b>53116</b>	R2250004C	Confezione 4 viti 4x4, 4 tasselli, chiave -4 screws 4x40, 4 raw plug, Allan key set	<b>3,00</b>
	R2500116	Piastrina conica Ø 45 mm - Conical plate Ø 45 mm	<b>3,00</b>
<b>53132</b>	R2250004C	Confezione 4 viti 4x4, 4 tasselli, chiave -4 screws 4x40, 4 raw plug, Allan key set	<b>3,00</b>
	R2500116	Piastrina conica Ø 45 mm - Conical plate Ø 45 mm	<b>3,00</b>
<b>44070</b>	R2253011	Guarnizione silicone Ø 70 mm - Silicon gasket Ø 70 mm	<b>3,00</b>
<b>53011</b>	R2253011	Guarnizione silicone Ø 70 mm - Silicon gasket Ø 70 mm	<b>3,00</b>
	R2250002C	Confezione 2 viti 4x40 + 2 tasselli + 1 chiave - 2 screws 4x40 + 2 raw plug + Allan key set	<b>3,00</b>
	R2500116	Piastrina conica Ø 45 mm - Conical plate Ø 45 mm	<b>3,00</b>
<b>53022</b>	R2553951	Pompetta completa in ottone cromato per dosatore in vetro e porcellana, Brass chromed pump for glass and porcelaine soap dispenser,	<b>20,00</b>
	R2344090	Pompetta per dosatore inox - Pump for soap dispenser in stainless steel	<b>17,00</b>
	R22440021	Tubetto in plastica per pompetta -Venduti pre-Aprile 2015 Plastic tube for pump - Articles sold before April 2015	<b>2,00</b>
	R2653022	Bottiglia in vetro acidato - Etched glass bottle	<b>17,00</b>
	R2153022	Bottiglia in porcellana - Porcelaine bottle	<b>39,00</b>
	R2353022	Bottiglia inox - Inox bottle	<b>50,00</b>
	R2244002	Tubetto per pompetta - Articoli venduti dopo Aprile 2015 Plastic tube for pump - Articles sold after April 2015	<b>2,00</b>
<b>53066</b>	R2253066	Guarnizione in silicone Ø 90 mm - Silicon gasket Ø 90 mm	<b>3,00</b>
	R2250002C	Confezione 2 viti 4x40 + 2 tasselli + 1 chiave - 2 screws 4x40 + 2 raw plug + Allan key set	<b>3,00</b>
	R2500116	Piastrina conica Ø 45 mm - Conical plate Ø 45 mm	<b>3,00</b>
<b>55062</b>	R2155062	Vaso porta scopino in porcellana - Porcelaine toilet brush holder	<b>20,00</b>
	R2652061	Vaso vetro acidato per porta scopino - Etched glass toilet brush	<b>16,00</b>
	R2250055	Setola scopino - Toilet brush	<b>6,00</b>
	R539329	Manico scopino cromato con ciuffo - Toilet brush with chromed stick	<b>19,00</b>
	R2250054	Copriscopino Ø 67 - Toilet brush lid Ø 67	<b>4,00</b>
	R2550069	Manico scopino 300 mm - Toilet brush handle 300 mm	<b>15,00</b>
<b>53141</b>	R2250004C	Confezione 4 viti 4x4, 4 tasselli, chiave -4 screws 4x40, 4 raw plug, Allan key set	<b>3,00</b>
	R2500116	Piastrina conica Ø 45 mm - Conical plate Ø 45 mm	<b>3,00</b>

## Ricambi / Spare parts / Pièces détachées / Ersatzteile

<b>53151</b>	R2250004C	Confezione 4 viti 4x4, 4 tasselli, chiave -4 screws 4x40, 4 raw plug, Allan key set	<b>3,00</b>
	R2500116	Piastrina conica Ø 45 mm - Conical plate Ø 45 mm	<b>3,00</b>
<b>53153</b>	R2250004C	Confezione 4 viti 4x4, 4 tasselli, chiave -4 screws 4x40, 4 raw plug, Allan key set	<b>3,00</b>
	R2500116	Piastrina conica Ø 45 mm - Conical plate Ø 45 mm	<b>3,00</b>
<b>52908</b>	R2250002C	Confezione 2 viti 4x40 + 2 tasselli + 1 chiave - 2 screws 4x40 + 2 raw plug + Allan key set	<b>3,00</b>
	R2500118	Kit piastrina conica + grano Ø 38 mm - Conical plate and screw kit Ø 38 mm	<b>3,00</b>
<b>52907</b>	R2250002C	Confezione 2 viti 4x40 + 2 tasselli + 1 chiave - 2 screws 4x40 + 2 raw plug + Allan key set	<b>3,00</b>
	R2500118	Kit piastrina conica + grano Ø 38 mm - Conical plate and screw kit Ø 38 mm	<b>3,00</b>
<b>52910</b>	R2250002C	Confezione 2 viti 4x40 + 2 tasselli + 1 chiave - 2 screws 4x40 + 2 raw plug + Allan key set	<b>3,00</b>
	R2500118	Kit piastrina conica + grano Ø 38 mm - Conical plate and screw kit Ø 38 mm	<b>3,00</b>
<b>52938</b>	R2250002C	Confezione 2 viti 4x40 + 2 tasselli + 1 chiave - 2 screws 4x40 + 2 raw plug + Allan key set	<b>3,00</b>
	R2500118	Kit piastrina conica + grano Ø 38 mm - Conical plate and screw kit Ø 38 mm	<b>3,00</b>
<b>52939</b>	R2250002C	Confezione 2 viti 4x40 + 2 tasselli + 1 chiave - 2 screws 4x40 + 2 raw plug + Allan key set	<b>3,00</b>
	R2500118	Kit piastrina conica + grano Ø 38 mm - Conical plate and screw kit Ø 38 mm	<b>3,00</b>
<b>52921</b>	R2250002C	Confezione 2 viti 4x40 + 2 tasselli + 1 chiave - 2 screws 4x40 + 2 raw plug + Allan key set	<b>3,00</b>
	R2500118	Kit piastrina conica + grano Ø 38 mm - Conical plate and screw kit Ø 38 mm	<b>3,00</b>
<b>52914</b>	R2250004C	Confezione 4 viti 4x4, 4 tasselli, chiave -4 screws 4x40, 4 raw plug, Allan key set	<b>3,00</b>
	R2500118	Kit piastrina conica + grano Ø 38 mm - Conical plate and screw kit Ø 38 mm	<b>3,00</b>
<b>52916</b>	R2250004C	Confezione 4 viti 4x4, 4 tasselli, chiave -4 screws 4x40, 4 raw plug, Allan key set	<b>3,00</b>
	R2500118	Kit piastrina conica + grano Ø 38 mm - Conical plate and screw kit Ø 38 mm	<b>3,00</b>
<b>52917</b>	R2250004C	Confezione 4 viti 4x4, 4 tasselli, chiave -4 screws 4x40, 4 raw plug, Allan key set	<b>3,00</b>
	R2500118	Kit piastrina conica + grano Ø 38 mm - Conical plate and screw kit Ø 38 mm	<b>3,00</b>
<b>52920</b>	R2250004C	Confezione 4 viti 4x4, 4 tasselli, chiave -4 screws 4x40, 4 raw plug, Allan key set	<b>3,00</b>
	R2500118	Kit piastrina conica + grano Ø 38 mm - Conical plate and screw kit Ø 38 mm	<b>3,00</b>
<b>52901</b>	R2152901	Bicchieri - Tumbler	<b>16,00</b>
	R2250002C	Confezione 2 viti 4x40 + 2 tasselli + 1 chiave - 2 screws 4x40 + 2 raw plug + Allan key set	<b>3,00</b>
	R2500118	Kit piastrina conica + grano Ø 38 mm - Conical plate and screw kit Ø 38 mm	<b>3,00</b>
<b>52902</b>	R2152902	Portasapone - Soap dish	<b>25,00</b>
	R2250002C	Confezione 2 viti 4x40 + 2 tasselli + 1 chiave - 2 screws 4x40 + 2 raw plug + Allan key set	<b>3,00</b>
	R2500118	Kit piastrina conica + grano Ø 38 mm - Conical plate and screw kit Ø 38 mm	<b>3,00</b>
<b>52926</b>	R2250004C	Confezione 4 viti 4x4, 4 tasselli, chiave -4 screws 4x40, 4 raw plug, Allan key set	<b>3,00</b>
	R2500118	Kit piastrina conica + grano Ø 38 mm - Conical plate and screw kit Ø 38 mm	<b>34,00</b>

## Ricambi / Spare parts / Pièces détachées / Ersatzteile

<b>52932</b>	R2250004C	Confezione 4 viti 4x4, 4 tasselli, chiave -4 screws 4x40, 4 raw plug, Allan key set	<b>4,00</b>
	R2500118	Kit piastrina conica + grano Ø 38 mm - Conical plate and screw kit Ø 38 mm	<b>4,00</b>
<b>52906</b>	R2152906	Portascopino - Towel brush	<b>19,00</b>
	R2250056	Copriscopino - Toilet brush	<b>4,00</b>
	R2250055	Setola scopino - Toilet brush	<b>6,00</b>
	R2250002C	Confezione 2 viti 4x40 + 2 tasselli + 1 chiave - 2 screws 4x40 + 2 raw plug + Allan key set	<b>3,00</b>
	R2500118	Kit piastrina conica + grano Ø 38 mm - Conical plate and screw kit Ø 38 mm	<b>34,00</b>
	R25529061	Manico scopino cromato - Toilet brush chrome	<b>23,00</b>
<b>61101</b>	R2661101	Bicchieri in vetro satinato - Satin glass tumbler	<b>27,00</b>
<b>61102</b>	R2661102	Piattino in vetro satinato - Satin glass soap dish	<b>21,00</b>
<b>61103</b>	R2661103	Bottiglia dosatore 250 ml in vetro satinato - Satin glass bottle 250 ml	<b>25,00</b>
	R25611032	Pompetta completa in ottone cromato per dosatore Brass chromed pump for glass soap dispenser	<b>21,00</b>
	R2461103222	Pompetta completa in ottone verniciato nero per dosatore Black painted pump for glass soap dispenser	<b>27,00</b>





# accessori appoggio

*Tabletop accessories / Accessoires à poser / Stand Accessoires*





## Saon

### Accessori appoggio

Tabletop accessories/ Accessoires à poser / Stand Accessoires

#### IT

##### Saon:

per noi veneti è il sapone, sia liquido che solido.

Una collezione completa di oggettistica da appoggio, dalle forme semplici e rigorose, realizzati nei materiali più vari.

Designers: OpenDesignItalia - Spiral Product Design - London - Mimmo Lorella

Porcellana smaltata, acciaio lucido, alluminio verniciato, vetro borosilicato soffiato a mano

#### EN

##### Saon:

for Venetians it is soap, both liquid and solid.

A complete collection of free-standing objects, characterised by simple and rigorous shapes, made using a large variety of materials.

Designers: OpenDesignItalia - Spiral Product Design - London - Mimmo Lorella

Glazed porcelain, polished steel, painted aluminium, hand-blown borosilicate glass

#### FR

##### Saon :

pour nous vénitiens, c'est le savon, aussi bien liquide que solide.

Une collection complète d'objets à poser, aux formes simples et précises, réalisés dans différents matériaux.

Designers : OpenDesignItalia - Spiral Product Design - Londres - Mimmo Lorella

Porcelaine émaillée, acier brillant, aluminium verni, verre borosilicate soufflé bouche

#### DE

##### Saon:

für uns aus Venetien die Seife, ob flüssig oder fest.

Eine vollständige Kollektion von Ablagen mit schlichten, strengen Formen, die in den verschiedensten Materialien hergestellt werden.

Designer: OpenDesignItalia - Spiral Product Design - London - Mimmo Lorella

Emailliertes Porzellan, glänzender Stahl, lackiertes Aluminium, handgeblasenes Borosilikatglas



## Saon

### Bicchiera

Tumbler / Verre / Becher

**44021.09**

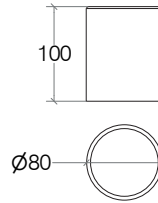

Porcellana  
Porcelaine  
Porcelaine  
Porzellan



.09

€ 18,00 - S

### Portasapone

Soap dish / Porte-savon / Seifenschale

**44022.09**

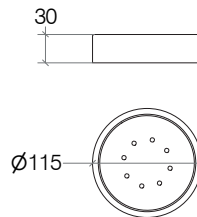

Porcellana  
Porcelaine  
Porcelaine  
Porzellan



.09

€ 29,00 - S

### Dosapapone 500 ml

Soap dispenser 500 ml / Distributeur savon liquide 500 ml / Seifenspender 500 ml

**44023.09**

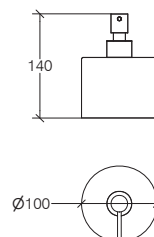

Porcellana  
Porcelaine  
Porcelaine  
Porzellan



.29



.22

€ 50,00 - M

**Dosapone 400 ml**

Soap dispenser 400 ml / Distributeur savon liquide 400 ml / Seifenspender 400 ml

**44024.09**

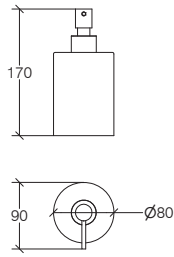

Porcellana  
Porcelaine  
Porcelaine  
Porzellan



.29

.22

€ 50,00 - M

**Bicchiere**

Tumbler / Verre / Becher

**44031.09**

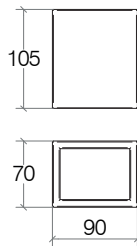

Porcellana  
Porcelaine  
Porcelaine  
Porzellan



.09

€ 38,00 - S

**Portasapone**

Soap dish / Porte-savon / Seifenschale

**44032.09**

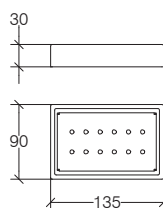

Porcellana  
Porcelaine  
Porcelaine  
Porzellan



.09

€ 40,00 - M

## Saon

### Dosasapone 400 ml

Soap dispenser 400 ml / Distributeur savon liquide 400 ml / Seifenspender 400 ml

**44033.nn**

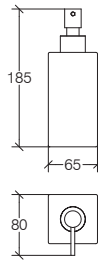

Porcellana  
Porcelaine  
Porcelaine  
Porzellan



.09.29

.09.22

€ 56,00 - M

### Dosasapone 600 m

Soap dispenser 600 ml / Distributeur savon liquide 600 ml / Seifenspender 600 ml

**44034.nn**

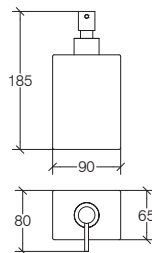

Porcellana  
Porcelaine  
Porcelaine  
Porzellan



.09.29

.09.22

€ 59,00 - M

### Dosasapone 500 ml

Soap dispenser 500 ml / Distributeur savon liquide 500 ml / Seifenspender 500 ml

**44041.nn**

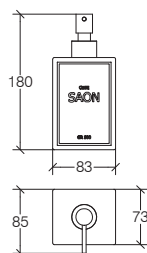

Porcellana  
Porcelaine  
Porcelaine  
Porzellan



.09.29

.09.22

€ 59,00 - M

**Tazza portaspazzolini**

Toothbrush holder mug / Porte-brosses à dents / Zahnbürstehalter

**44025.09**

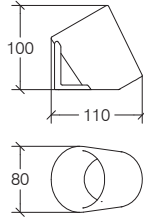

Ceramica  
Ceramic  
Céramique  
Keramik



.09

ITALY

€ 33,00 - S

**Bicchieri e dosasapone**

Tumbler and soap dispenser / Verre et distributeur savon liquide / Becher und Seifenspender

**4072.80**

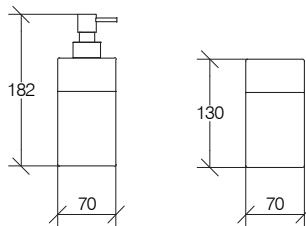

Vetro borosilicato trasparente  
Borosilicated glass  
Verre borosilicate  
Borosilikatglas



.80

ITALY

€ 114,00 - M

**Dosasapone 250 m**

Soap dispenser 250 ml / Distributeur savon liquide 250 ml / Seifenspender 250 ml

**44018.nn**

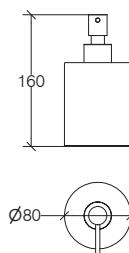

Alluminio verniciato  
Painted aluminium  
Aluminium laqué  
Lackiertem Aluminium

Acciaio inox lucido  
Polished stainless steel  
Acier inoxydable brillant  
Poliert Edelstahl



.09

.17

.18

.29

€ 42,00 - M

€ 65,00 - M

ITALY

## Saon

### Dosapone 220 ml

Soap dispenser 220 ml / Distributeur savon liquide 220 ml / Seifenspender 220 ml

4400.nn

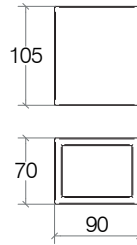

**Ottone cromato**  
Chromed brass  
Laiton chromé  
Verchromtes Messing

**Ottone verniciato**  
Painted brass  
Laiton laqué  
Lackiertem Messing



.29



.22

€ 53,00 - M

### Bicchieri

Tumbler / Verre / Becher

4412.09

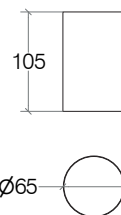

**Acciaio inox lucido**  
Polished stainless steel  
Acier inoxydable brillant  
Poliert Edelstahl



.29

€ 28,00 - S

### Portasapone

Soap dish / Porte-savon / Seifenschale

4413.29

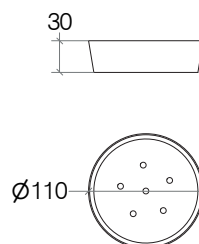

**Acciaio inox lucido**  
Polished stainless steel  
Acier inoxydable brillant  
Poliert Edelstahl



.29

€ 32,00 - S



**Bicchieri**

Tumbler / Verre / Becher

**4414.29**

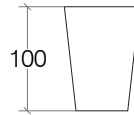

**Acciaio inox lucido**  
Polished stainless steel  
Acier inoxydable brillant  
Poliert Edelstahl



.29

€ 27,00 - S

**Contentore portasalviette**

Hand towels box / Récipient porte-serviettes lave-mains / Behälter für Schalehandtücher

**44281.29**

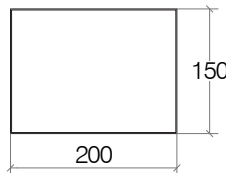

**Acciaio inox lucido**  
Polished stainless steel  
Acier inoxydable brillant  
Poliert Edelstahl



.29

€ 66,00 - M

**Dosapone 350 ml**

Soap dispenser 350 ml / Distributeur savon liquide 350 ml / Seifenspender 350 ml

**528041.29**

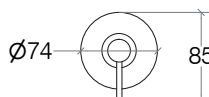
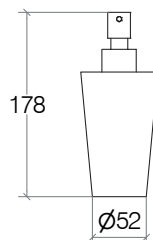

**Acciaio inox lucido**  
Polished stainless steel  
Acier inoxydable brillant  
Poliert Edelstahl



.29

€ 57,00 - M

## Saon

### Bicchiere

Tumbler / Verre / Becher

**55003.nn**

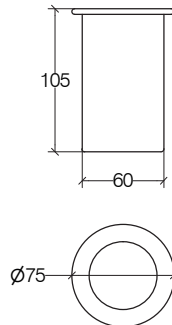

**Porcellana**  
Porcelaine  
Porcelaine  
Porzellan



.09

**Vetro acidato**  
Etched glass  
Verre dépoli  
Geätztes Glas



.81

€ 16,00 - S

### Portasapone

Soap dish / Porte-savon / Seifenschale

**55004.nn**

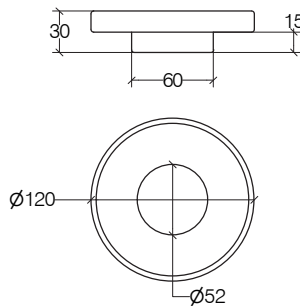

**Porcellana**  
Porcelaine  
Porcelaine  
Porzellan



.09

**Vetro acidato**  
Etched glass  
Verre dépoli  
Geätztes Glas



.81

€ 16,00 - S

### Dosapapone 200 ml

Soap dispenser 200 ml / Distributeur savon liquide 200 ml / Seifenspender 200 ml

**55006.nn**

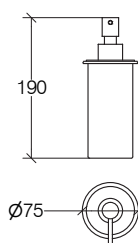

**Porcellana**  
Porcelaine  
Porcelaine  
Porzellan



.09 .09.22

**Vetro acidato**  
Etched glass  
Verre dépoli  
Geätztes Glas



.81 .81.22

€ 40,00 - S



**Griglietta in silicone antiscivolo per Art. 55004 (20 pezzi assortiti in 4 colori)**

**5200.nn**

20 grip grids for soap dish 55004 / Grille en silicone 20 picks pour porte-savon 55004 / 20 Einlagen für Seifenschale 55004

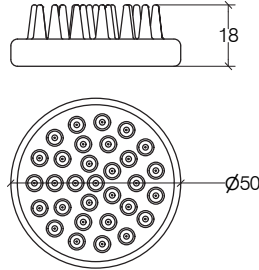

Silicone  
Silicon  
Silicone  
Silikon



€ 38,00 - S

**Portasapone**

Soap dish / Porte-savon / Seifenschale

**3901.nn**

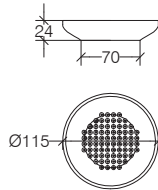

Silicone  
Silicon  
Silicone  
Silikon



€ 13,00 - S

**Portasapone**

Soap dish / Porte-savon / Seifenschale

**3902.nn**

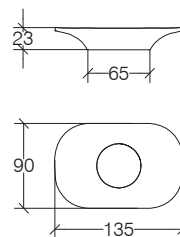

Silicone  
Silicon  
Silicone  
Silikon



€ 11,00 - S

## Saon

### Bicchiera

Tumbler / Verre / Becher

3903.nn

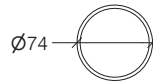
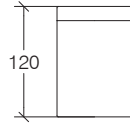

Silicone  
Silicon  
Silicone  
Silikon



.15



.16



.17

€ 11,00 - S

### Dosasapone 200 ml

Soap dispenser 200 ml / Distributeur savon liquide 200 ml / Seifenspender 200 ml

3905.nn

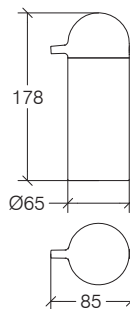

Silicone  
Silicon  
Silicone  
Silikon



.15



.16



.17

€ 16,00 - S

### Ghiera per accessori da appoggio

Tabletop ring accessories / Anneau d'appui pour accessoires / Ring für Accessories

44070.29

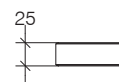

Ottone cromato  
Chromed brass  
Laiton chromé  
Verchromtes Messing



.29

€ 13,00 - S

**Bicchieri**

Tumbler / Verre / Becher

**53020.nn**

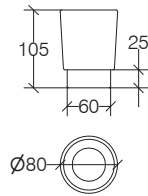

**Porcellana**  
Porcelaine  
Porcelaine  
Porzellan



.09

€ 20,00

**Acciaio inox lucido**  
Polished stainless steel  
Acier inoxydable brillant  
Poliert Edelstahl



.29

€ 38,00

**Vetro acidato**  
Etched glass  
Verre dépoli  
Geätztes Glas



.81

€ 15,00



**Portasapone**

Soap dish / Porte-savon / Seifenschale

**53021.nn**

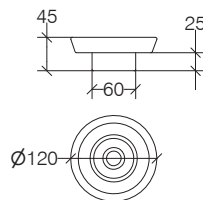

**Porcellana**  
Porcelaine  
Porcelaine  
Porzellan



.09

€ 22,00

**Acciaio inox lucido**  
Polished stainless steel  
Acier inoxydable brillant  
Poliert Edelstahl



.29

€ 38,00

**Vetro acidato**  
Etched glass  
Verre dépoli  
Geätztes Glas



.81

€ 17,00

**Dosasapone 300 ml**

Soap dispenser 300 ml / Distributeur savon liquide 300 ml / Seifenspender 300 ml

**53022.nn**

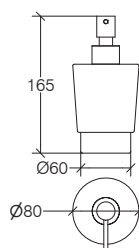

**Porcellana**  
Porcelaine  
Porcelaine  
Porzellan



.09

€ 46,00

**Acciaio inox lucido**  
Polished stainless steel  
Acier inoxydable brillant  
Poliert Edelstahl



.29

€ 50,00

**Vetro acidato**  
Etched glass  
Verre dépoli  
Geätztes Glas



.81

€ 42,00

## Ricambi / Spare parts / Pièces détachées / Ersatzteile

<b>44022</b>	R2344022	Griglia per art, 4422 - Grid for art, 4422	<b>12,00</b>
<b>44023</b>	R2553951	Pompetta completa in ottone cromato per dosasapone in vetro e porcellana Brass chromed pump for glass and porcelaine soap dispenser	<b>20,00</b>
	R22440021	Tubetto in plastica per pompetta - Venduti pre-Aprile 2015 Plastic tube for pump - Articles sold before April 2015	<b>2,00</b>
	R2144023	Spandisapone, 500 ml - Soap dispenser 500 ml	<b>24,00</b>
	R2244002	Tubetto per pompetta - Articoli venduti dopo Aprile 2015 Plastic tube for pump - Articles sold after April 2015	<b>2,00</b>
<b>44024</b>	R2553951	Pompetta completa in ottone cromato per dosatore in vetro e porcellana Brass chromed pump for glass and porcelaine soap dispenser	<b>20,00</b>
	R22440021	Tubetto in plastica per pompetta - Venduti pre-Aprile 2015 Plastic tube for pump - Articles sold before April 2015	<b>2,00</b>
	R2144024	Spandisapone, 400 ml - Soap dispenser 400 ml	<b>24,00</b>
	R2244002	Tubetto per pompetta - Articoli venduti dopo Aprile 2015 Plastic tube for pump - Articles sold after April 2015	<b>2,00</b>
<b>44032</b>	R2344032	Griglia per art, 44032 - Grid for art, 44032	<b>17,00</b>
<b>44033</b>	R2553951	Pompetta completa in ottone cromato per dosasapone in vetro e porcellana Brass chromed pump for glass and porcelaine soap dispenser	<b>20,00</b>
	R22440021	Tubetto in plastica per pompetta - Venduti pre-Aprile 2015 Plastic tube for pump - Articles sold before April 2015	<b>2,00</b>
	R2144033	Spandisapone, 400 ml - Soap dispenser 400 ml	<b>29,00</b>
	R2244002	Tubetto per pompetta - Articoli venduti dopo Aprile 2015 Plastic tube for pump - Articles sold after April 2015	<b>2,00</b>
<b>44034</b>	R2553951	Pompetta completa in ottone cromato per dosasapone in vetro e porcellana Brass chromed pump for glass and porcelaine soap dispenser	<b>20,00</b>
	R22440021	Tubetto in plastica per pompetta - Venduti pre-Aprile 2015 Plastic tube for pump - Articles sold before April 2015	<b>2,00</b>
	R2144034	Spandisapone, 600 ml - Soap dispenser 600 ml	<b>34,00</b>
	R2244002	Tubetto per pompetta - Articoli venduti dopo Aprile 2015 Plastic tube for pump - Articles sold after April 2015	<b>2,00</b>
<b>44041</b>	R2553951	Pompetta completa in ottone cromato per dosasapone in vetro e porcellana Brass chromed pump for glass and porcelaine soap dispenser	<b>20,00</b>
	R22440021	Tubetto in plastica per pompetta - Venduti pre-Aprile 2015 Plastic tube for pump - Articles sold before April 2015	<b>2,00</b>
	R21440419	Dosasapone - Soap dispenser	<b>39,00</b>
	R2244002	Tubetto per pompetta - Articoli venduti dopo Aprile 2015 Plastic tube for pump - Articles sold after April 2015	<b>2,00</b>
<b>4400</b>	R2553951	Pompetta completa in ottone cromato per dosasapone in vetro e porcellana Brass chromed pump for glass and porcelaine soap dispenser	<b>20,00</b>
	R2240403	Flacone in plastica, 220 ml - Plastic dispenser, 220 ml	<b>4,00</b>
	R22440021	Tubetto in plastica per pompetta - Venduti pre-Aprile 2015 Plastic tube for pump - Articles sold before April 2015	<b>2,00</b>
	R2200108	O-ring - O-ring	<b>3,00</b>
	R2244002	Tubetto per pompetta - Articoli venduti dopo Aprile 2015 Plastic tube for pump - Articles sold after April 2015	<b>2,00</b>
<b>4413</b>	R23441312	Griglia - Grid	<b>17,00</b>
<b>44018</b>	R2553951	Pompetta completa in ottone cromato per dosasapone in vetro e porcellana Brass chromed pump for glass and porcelaine soap dispenser	<b>20,00</b>
	R22440181	Flacone plastica interno - Internal plastic container	<b>4,00</b>
	R2244002	Tubetto per pompetta - Articoli venduti dopo Aprile 2015 Plastic tube for pump - Articles sold after April 2015	<b>2,00</b>

**Ricambi / Spare parts / Pièces détachées / Ersatzteile**



<b>44070</b>	R2253011	Guarnizione silicone Ø 70 mm - Silicon gasket Ø 70 mm	<b>3,00</b>
<b>55006</b>	R2553951	Pompetta completa in ottone cromato per dosasapone in vetro e porcellana Brass chromed pump for glass and porcelaine soap dispenser	<b>20,00</b>
	R2652031	Vaso vetro acidato per dosatore, 200 ml - Etched glass soap dispenser, 200 ml	<b>15,00</b>
	R2652032	Vaso vetro trasparente per dosasapone, 200 ml - Clear glass soap dispenser, 200 ml	<b>15,00</b>
	R2155006	Vaso porcellana per dosasapone, 200 ml - Porcelaine soap dispenser holder, 200 ml	<b>15,00</b>
	R2244002	Tubetto per pompetta - Articoli venduti dopo Aprile 2015 Plastic tube for pump - Articles sold after April 2015	<b>2,00</b>
	R2255006	Guarnizione in plastica - Plastic gasket	<b>5,00</b>
	R25550061	Ghiera in ottone con guarnizione in plastica - Chromed brass ring with plastic gasket	<b>9,00</b>
<b>53022</b>	R2553951	Pompetta completa in ottone cromato per dosasapone in vetro e porcellana Brass chromed pump for glass and porcelaine soap dispenser	<b>20,00</b>
	R2344090	Pompetta per dosatore inox - Pump for soap dispenser in stainless steel	<b>17,00</b>
	R22440021	Tubetto in plastica per pompetta - Venduti pre-Aprile 2015 Plastic tube for pump - Articles sold before April 2015	<b>2,00</b>
	R2653022	Bottiglia in vetro acidato - Etched glass bottle	<b>17,00</b>
	R2153022	Bottiglia in porcellana - Porcelaine bottle	<b>39,00</b>
	R2353022	Bottiglia in acciaio inox - Inox bottle	<b>50,00</b>
	R2244002	Tubetto per pompetta - Articoli venduti dopo Aprile 2015 Plastic tube for pump - Articles sold after April 2015	<b>2,00</b>

# scopini

*Toilet Brush Holders / Porte-balais / Wc Bürstenbehälter*

## **Scopini da pavimento / 168**

*Floor toilet brush holders / Porte-balais à poser / WC-Bürstengarnitur am Boden*

## **Scopini a parete / 176**

*Wall toilet brush holders / Porte-balais muraux / WC-Bürstengarnitur Wandmodell*







## Baston

### Portascopino

Toilet brush holder / Porte-balai / Wc-Bürstengarnitur

5021.17

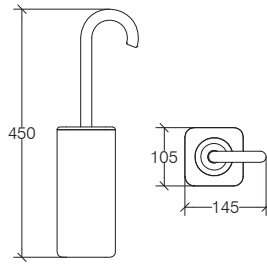

**Silicone**  
Silicon  
Silicone  
Silikon

**Ceramica**  
Ceramic  
Céramique  
Keramik



.17

€ 68,00 - M

ITALY

### Portascopino

Toilet brush holder / Porte-balai / Wc-Bürstengarnitur

5022.15

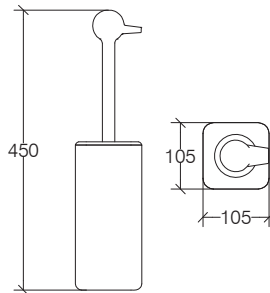

**Silicone**  
Silicon  
Silicone  
Silikon

**Ceramica**  
Ceramic  
Céramique  
Keramik



.15

€ 68,00 - M

ITALY

**Portascopino**

Toilet brush holder / Porte-balai / Wc-Bürstengarnitur

**5023.11**

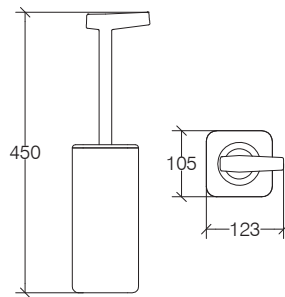

**Silicone**  
Silicon  
Silicone  
Silikon

**Ceramica**  
Ceramic  
Céramique  
Keramik



**.11**

€ 68,00 - M



**Portascopino**

Toilet brush holder / Porte-balai / Wc-Bürstengarnitur

**5024.nn**

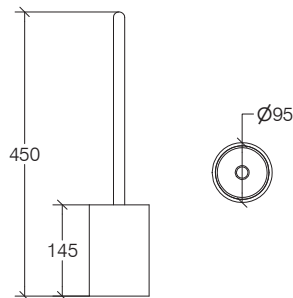
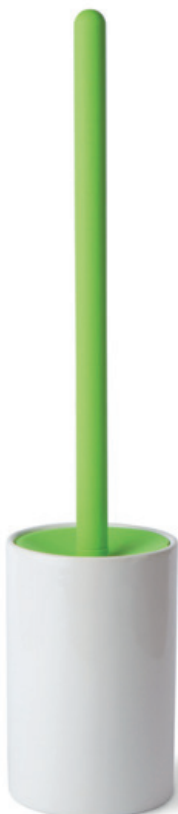

**Silicone**  
Silicon  
Silicone  
Silikon

**Ceramica**  
Ceramic  
Céramique  
Keramik



**.09**



**.13**



**.15**



**.16**



**.17**

€ 38,00 - S

## Skoati

### Portascopino da pavimento e a parete

Floor and wall toilet brush holder / Porte-balai mural ou à poser / Wand oder Boden WC Bürstengarnitur

50042.nn

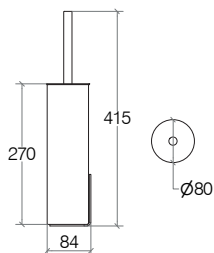

**Acciaio inox lucido**  
Polished stainless steel  
Acier inox brillant  
Glänzer Edelstahl

**Alluminio verniciato**  
Painted aluminium  
Aluminium laqué  
Lackiertem Aluminium

**Acciaio inox satinato**  
Satinated stainless steel  
Acier inox satiné  
Vereist Edelstahl

**Acciaio inox nickel nero**  
Black nickel stainless steel  
Acier inox nickel noir  
Schwarznickel Edelstahl



€ 80,00 - M

€ 88,00 - M

€ 203,00 - L

ITALY

### Portascopino

Toilet brush holder / Porte-balai / WC-Bürste

50055.nn

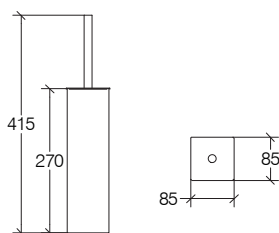

**Acciaio inox lucido**  
Polished stainless steel  
Acier inox brillant  
Glänzer Edelstahl

**Alluminio verniciato**  
Painted aluminium  
Aluminium laqué  
Lackiertem Aluminium

**Acciaio inox satinato**  
Satinated stainless steel  
Acier inox satiné  
Vereist Edelstahl

**Acciaio inox nickel nero**  
Black nickel stainless steel  
Acier inox nickel noir  
Schwarznickel Edelstahl

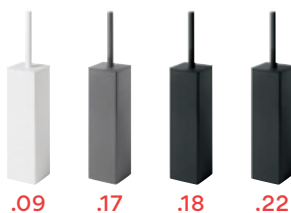

€ 88,00 - M

€ 106,00 - M

€ 242,00 - L

ITALY

**Portascopino**

**50203.29.09**

Toilet brush holder / Porte-balai / Wc-Bürstengarnitur

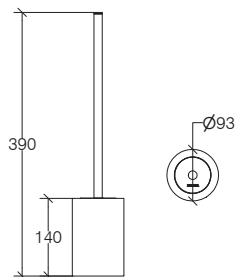

**Ottone cromato**  
Chromed brass  
Laiton chromé  
Verchromtes Messing

**Porcellana**  
Porcelaine  
Porcelaine  
Porzellan



**.29.09**

€ 45,00 - S

**Portascopino**

**50207.29**

Toilet brush holder / Porte-balai / Wc-Bürstengarnitur

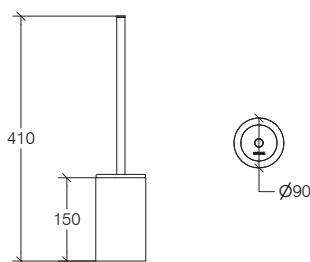

**Ottone cromato**  
Chromed brass  
Laiton chromé  
Verchromtes Messing



**.29**

€ 72,00 - M

## Balenghi

### Portascopino

5008.29

Toilet brush holder / Porte-balai / Wc-Bürstengarnitur

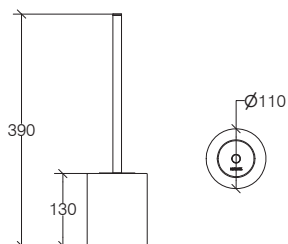

Acciaio inox lucido  
Polished stainless steel  
Acier inox brillant  
Glänzer Edelstahl



.29

€ 73,00 - S

### Portascopino "BAJLE"

5010.29

Toilet brush holder "BAJLE" / Porte-balai "BAJLE" / Toilettenbürstengarnitur "BAJLE"

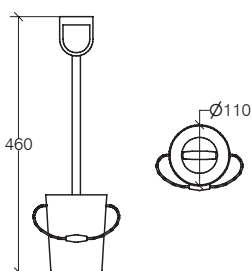

Acciaio inox lucido  
Polished stainless steel  
Acier inox brillant  
Glänzer Edelstahl



.29

€ 116,00 - M

**Portascopino "BUTTO"**

**5011.29**

Toilet brush holder "BUTTO" / Porte-balai "BUTTO" / Toilettenbürstengarnitur "BUTTO"

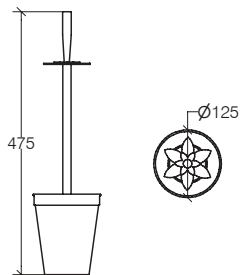

**Acciaio inox lucido**  
Polished stainless steel  
Acier inox brillant  
Glänzer Edelstahl



.29

€ 116,00 - M

**Portascopino "PESSÉ"**

**5012.29**

Toilet brush holder "PESSÉ" / Porte-balai "PESSÉ" / Toilettenbürstengarnitur "PESSÉ"

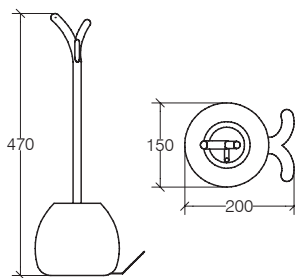

**Acciaio inox lucido**  
Polished stainless steel  
Acier inox brillant  
Glänzer Edelstahl



.29

€ 116,00 - M

## Balenghi

### Portascopino "VOVO"

5013.29

Toilet brush holder "VOVO" / Porte-balai "VOVO" / Toilettenbürstengarnitur "VOVO"

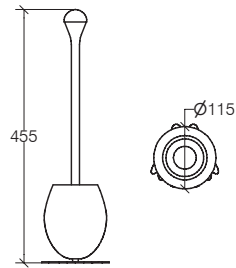

**Acciaio inox lucido**  
*Polished stainless steel*  
*Acier inox brillant*  
*Glänzer Edelstahl*



.29

€ 116,00 - M

### Portascopino "LONGA"

5014.29

Toilet brush holder "LONGA" / Porte-balai "LONGA" / Toilettenbürstengarnitur "LONGA"

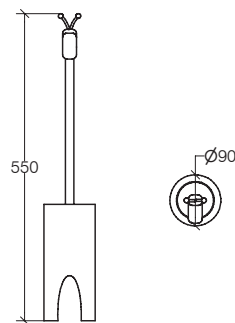

**Acciaio inox lucido**  
*Polished stainless steel*  
*Acier inox brillant*  
*Glänzer Edelstahl*



.29

€ 116,00 - M



**Portascopino "CALA"**

**5015.29**

Toilet brush holder CALA" / Porte-balai "CALA" / Toilettenbürstengarnitur "CALA"

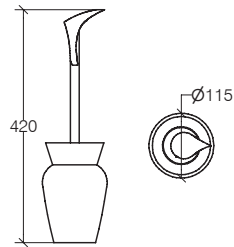

**Acciaio inox lucido**  
*Polished stainless steel*  
*Acier inox brillant*  
*Glänzer Edelstahl*



.29

€ 116,00 - M

## Skoati

### Portascopino da pavimento e a parete

Floor and wall toilet brush holder / Porte-balai mural ou à poser / Wand oder Boden WC Bürstengarnitur

50042.nn

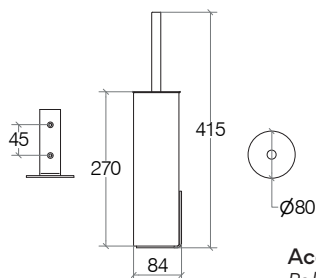

**Acciaio inox lucido**  
Polished stainless steel  
Acier inox brillant  
Glänzer Edelstahl

**Alluminio verniciato**  
Painted aluminium  
Aluminium laqué  
Lackiertem Aluminium

**Acciaio inox satinato**  
Satinated stainless steel  
Acier inox satiné  
Vereist Edelstahl

**Acciaio inox nickel nero**  
Black nickel stainless steel  
Acier inox nickel noir  
Schwarznickel Edelstahl



.09 .17 .18 .22

€ 80,00 - M



.29 .32

€ 88,00 - M



.33

€ 203,00 - L

ITALY

### Portascopino a parete

Wall toilet brush holder / Porte-balai carré mural / Toilettenbürstengarnitur Wandmodell

50056.nn

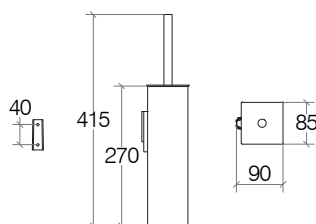

**Acciaio inox lucido**  
Polished stainless steel  
Acier inox brillant  
Glänzer Edelstahl

**Alluminio verniciato**  
Painted aluminium  
Aluminium laqué  
Lackiertem Aluminium

**Acciaio inox satinato**  
Satinated stainless steel  
Acier inox satiné  
Vereist Edelstahl

**Acciaio inox nickel nero**  
Black nickel stainless steel  
Acier inox nickel noir  
Schwarznickel Edelstahl



.09 .17 .18 .22

€ 109,00 - M



.29 .32

€ 114,00 - M



.33

€ 250,00 - L

ITALY

## Ricambi / Spare parts / Pièces détachées / Ersatzteile

<b>5021</b>	R2250057	Ciuffo in silicone grigio - Silicon toilet brush grey	<b>10,00</b>
	R215021	Tazza portascopino in ceramica - Ceramic toilet brush holder	<b>37,00</b>
	R22502117	Manico e scopino silicone grigio Gray silicon toilet brush and handle	<b>25,00</b>
<b>5022</b>	R2250057	Ciuffo in silicone grigio - Silicon toilet brush grey	<b>10,00</b>
	R215021	Tazza portascopino in ceramica - Ceramic toilet brush holder	<b>37,00</b>
	R22502215	Manico e scopino silicone arancione - Orange silicon toilet brush and handle	<b>25,00</b>
<b>5023</b>	R2250057	Ciuffo in silicone grigio - Silicon toilet brush grey	<b>10,00</b>
	R215021	Tazza portascopino in ceramica - Ceramic toilet brush holder	<b>37,00</b>
	R22502311	Manico e scopino silicone rosso - Silicon red toilet brush with handle	<b>25,00</b>
<b>5024</b>	R225023109	Manico scopino silicone bianco - White silicon handle for toilet brush	<b>20,00</b>
	R225023113	Manico scopino silicone verde - Green silicon handle for toilet brush	<b>20,00</b>
	R225023115	Manico scopino silicone arancio - Orange silicon handle for toilet brush	<b>20,00</b>
	R225023116	Manico scopino silicone fucsia - Fuchsia silicon handle for toilet brush	<b>20,00</b>
	R225023117	Manico scopino silicone grigio - Grey silicon handle for toilet brush	<b>20,00</b>
	R2250061	Setola scopino Ø 74 bianco - White toilet brush Ø 74	<b>7,00</b>
	R215023	Tazza scopino ceramica - Ceramic toilet brush holder	<b>27,00</b>
<b>50042</b>	R22500521	Tazza in plastica grigia tonda - Round plastic grey cup	<b>5,00</b>
	R2250051	Setola scopino con manico - Toilet brush with handle	<b>7,00</b>
	R2350047	Manico scopino lucido - Polished handle	<b>30,00</b>
	R2350040	Coperchio + sottocoperchio tondo - Round lid + undercover	<b>20,00</b>
<b>50055</b>	R22500321	Tazza in plastica portascopino grigia 80x80x260 mm - Grey plastic cup 80x80x260 mm	<b>7,00</b>
	R2250051	Setola scopino con manico - Toilet brush with handle	<b>7,00</b>
	R2350050	Coperchio + sottocoperchio quadro - Drain lid	<b>20,00</b>
	R2350047	Manico scopino lucido - Polished handle	<b>30,00</b>
<b>50203</b>	R539329	Manico scopino cromato con ciuffo - Toilet brush with chromed stick	<b>19,00</b>
	R2250054	Copriscopino Ø 67 - Toilet brush lid Ø 67	<b>4,00</b>
	R2250055	Setola scopino - Toilet brush	<b>6,00</b>
	R2150203	Tazza ceramica scopino - Toilet brush holde	<b>29,00</b>
	R2550069	Manico scopino 300 mm - Toilet brush handle 300 mm	<b>15,00</b>
<b>50207</b>	R2652061	Vaso vetro acidato per Portascopino - Etched glass toilet brush	<b>16,00</b>
	R539329	Manico scopino cromato con ciuffo - Toilet brush with chromed stick	<b>19,00</b>
	R2250054	Copriscopino Ø 67 - Toilet brush lid Ø 67	<b>4,00</b>
	R2250055	Setola scopino - Toilet brush	<b>6,00</b>
	R2550069	Manico scopino 300 mm - Toilet brush handle 300 mm	<b>15,00</b>
	R2255061	Guarnizione in silicone Ø 90 mm Silicon gasket Ø 90 mm	<b>3,00</b>

**Ricambi / Spare parts / Pièces détachées / Ersatzteile**

<b>5008</b>	R539329	Manico scopino cromato con ciuffo - Toilet brush with chromed stick	<b>19,00</b>
	R2250054	Copriscopino Ø 67 - Toilet brush lid Ø 67	<b>4,00</b>
	R2250055	Setola scopino - Toilet brush	<b>6,00</b>
	R2550069	Manico scopino 300 mm - Toilet brush handle 300 mm	<b>15,00</b>
<b>5012</b>	R2250056	Copri scopino - Toilet brush lid	<b>4,00</b>
	R2250055	Setola scopino - Toilet brush	<b>6,00</b>
	R2550122	Manico scopino Pesse - Toilet Brush stick for Pesse	<b>58,00</b>
	R2350121	Tazza scopino balena inox - Toilet brush holder whale inox	<b>70,00</b>
<b>5011</b>	R2250056	Copri scopino - Toilet brush lid	<b>4,00</b>
	R2250055	Setola scopino - Toilet brush	<b>6,00</b>
	R2550112	Manico scopino Butto - Toilet Brush stick for Butto	<b>58,00</b>
	R2350111	Tazza scopino vaso inox - Toilet brush holder vase inox	<b>59,00</b>
<b>5013</b>	R2250056	Copri scopino - Toilet brush lid	<b>4,00</b>
	R2250055	Setola scopino - Toilet brush	<b>6,00</b>
	R2550132	Manico scopino Vovo - Toilet Brush stick for Vovo	<b>58,00</b>
	R2350131	Tazza scopino pulcino inox - Toilet brush holder chick inox	<b>65,00</b>
<b>5010</b>	R2250056	Copri scopino - Toilet brush lid	<b>4,00</b>
	R2250055	Setola scopino - Toilet brush	<b>6,00</b>
	R2550102	Manico scopino Bajle - Toilet Brush stick for Bajle	<b>54,00</b>
	R2350101	Tazza scopino secchiello inox - Toilet brush holder bucket polished inox	<b>65,00</b>
<b>5015</b>	R2250056	Copri scopino - Toilet brush lid	<b>4,00</b>
	R2250055	Setola scopino - Toilet brush	<b>6,00</b>
	R2550151	Manico scopino Cala - Toilet Brush stick for Cala	<b>58,00</b>
	R2350151	Tazza scopino 'CALA' inox - Toilet brush holder 'CALA' inox	<b>69,00</b>
<b>5014</b>	R2250056	Copri scopino - Toilet brush lid	<b>4,00</b>
	R2250055	Setola scopino - Toilet brush	<b>6,00</b>
	R2550142	Manico scopino Longa - Toilet Brush stick for Longa	<b>58,00</b>
	R2350141	Tazza scopino giraffa inox - Toilet brush holder giraffe inox	<b>70,00</b>

## Ricambi / Spare parts / Pièces détachées / Ersatzteile

<b>50042</b>	R22500521	Tazza in plastica grigia tonda - Round plastic grey cup	<b>5,00</b>
	R2250051	Setola scopino con manico - Toilet brush with handle	<b>7,00</b>
	R2350047	Manico scopino lucido - Polished handle	<b>30,00</b>
	R2350040	Coperchio + sottocoperchio tondo - Round lid + undercover	<b>20,00</b>
	R2250002	Confezione 2 viti 4x40 + 2 tasselli - 2 screws 4x40 + 2 raw plug set	<b>3,00</b>
<b>50056</b>	R22500321	Tazza in plastica portascopino grigia 80x80x260 mm - Grey plastic cup 80x80x260 mm	<b>7,00</b>
	R2250051	Setola scopino con manico - Toilet brush with handle	<b>7,00</b>
	R2350047	Manico scopino lucido - Polished handle	<b>30,00</b>
	R2350050	Coperchio + sottocoperchio quadro - Square drain lid	<b>20,00</b>
	R2250002	Confezione 2 viti 4x40 + 2 tasselli - 2 screws 4x40 + 2 raw plug set	<b>2,00</b>



# piantane

*Stands / Ensembles d'accessoires sur pied / Wc Kombination und Handtuchständer*



## Grela

### Scaletta portasalviette

Towel ladder / Echelle porte-serviettes / Handtuchleiter

5118.nn

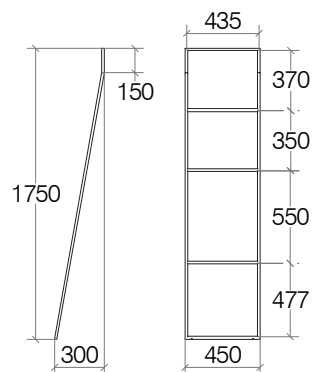

**Acciaio verniciato**  
Painted steel  
Acier laqué  
Lackiertes edelstahl



.09

.18

€ 337,00 - L

**Acciaio inox 304 lucido**  
304 polished stainless steel  
Acier inoxydable 304 brillant  
304 polierter Edelstahl



.29

€ 439,00 - L

**Acciaio inox nickel nero**  
Black nickel stainless steel  
Acier inox nickel noir  
Schwarznickel Edelstahl



.33

€ 521,00 - L



**Scaletta portasalviette**

Towel ladder / Echelle porte-serviettes / Handtuchleiter

5130.nn

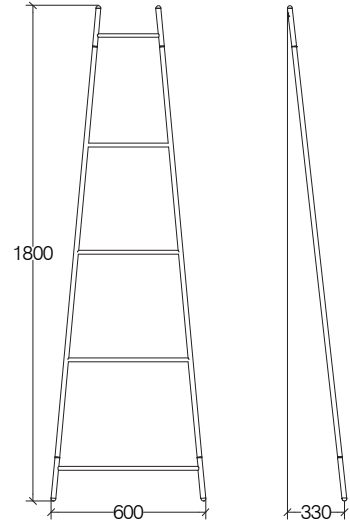
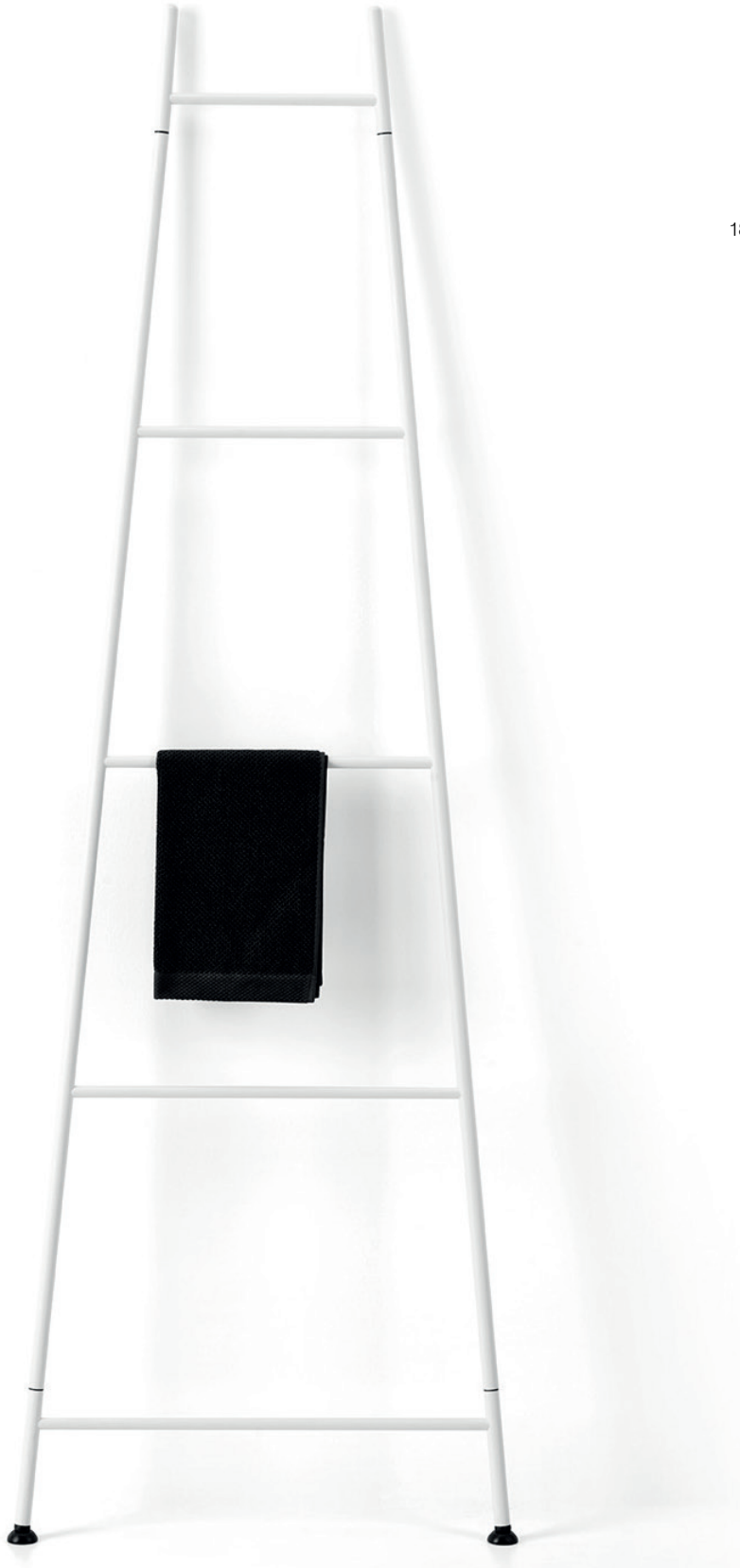

**Metallo verniciato**  
*Painted metal*  
*Métal laqué*  
*Lackiertes Metall*



.09

.18

€ 193,00 - M

## Stela

### Piantana con vassoio, portarotolo e portascopino

5111.nn

Toilet paper and brush holder stand / Porte-rouleau et balai sur pied / Kombi-Bürstengarnitur mit Papierhalter und WC-Bürste

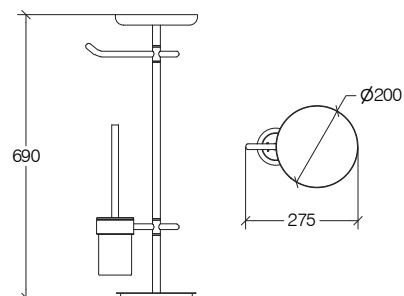

**Metallo verniciato**  
Painted metal  
Métal laqué  
Lackiertes Metall



.09

.18

€ 186,00 - M



### Piantana con portarotolo e portascopino

5111.nn

Toilet paper and brush holder stand / Porte-rouleau et balai sur pied / Kombi-Bürstengarnitur mit Papierhalter und WC-Bürste

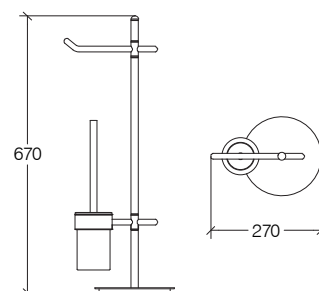

**Metallo verniciato**  
Painted metal  
Métal laqué  
Lackiertes Metall



.09

.18

€ 159,00 - M



**Piantana con 2 barre portasalvietta e vassoio**

Towel-stand, 2 arms / Porte-serviettes 2 barres sur pied / Handtuchständer mit 2 Arme

**5112.nn**

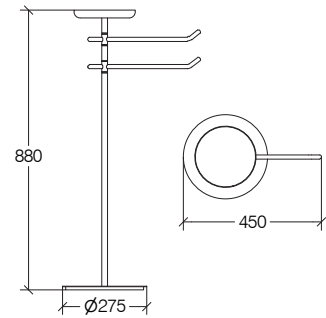

**Metallo verniciato**  
Painted metal  
Métal laqué  
Lackiertes Metall



.09

.18

€ 249,00 - M



**Piantana con 3 barre portasalvietta**

Towel-stand, 3 arms / Porte-serviettes 3 barres sur pied / Handtuchständer mit 3 Arme

**51121.nn**

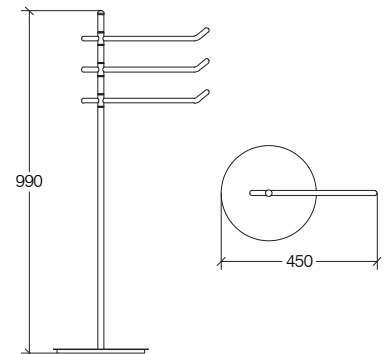

**Metallo verniciato**  
Painted metal  
Métal laqué  
Lackiertes Metall



.09

.18

€ 249,00 - M



## Grela

### Piantana portarotolo e portascopino

Toilet paper and brush holder stand / Porte-rouleau sur pied avec porte-balais / Kombi-Bürstengarnitur

5116.nn

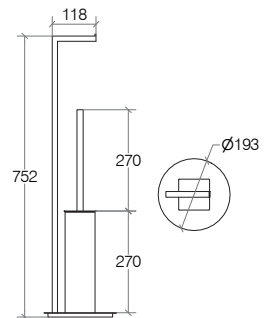

**Acciaio verniciato**  
Painted steel  
Acier laqué  
Lackiertes edelstahl



.09 .18

€ 327,00 - L

**Acciaio inox lucido**  
Polished stainless steel  
Acier inoxydable brillant  
Polierter Edelstahl



.29

€ 388,00 - L

**Acciaio inox nickel nero**  
Black nickel stainless steel  
Acier inox nickel noir  
Schwarznickel Edelstahl



.33

€ 429,00 - L

ITALY

### Piantana portasalviette

Towel holder stand / Porte-serviettes sur pied / Handtuchständer

5117.nn

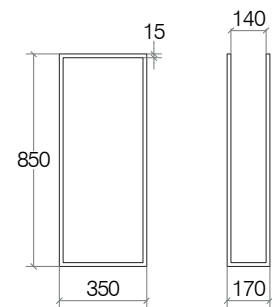

**Acciaio verniciato**  
Painted steel  
Acier laqué  
Lackiertes edelstahl



.09 .18

€ 306,00 - L

**Acciaio inox lucido**  
Polished stainless steel  
Acier inoxydable brillant  
Polierter Edelstahl



.29

€ 368,00 - L

**Acciaio inox nickel nero**  
Black nickel stainless steel  
Acier inox nickel noir  
Schwarznickel Edelstahl



.33

€ 408,00 - L

ITALY

## Ranpin

### Piantana portarotolo e portascopino

5113.29

Toilet paper and brush holder stand / Porte-rouleau sur pied avec porte-balais / Kombi-Bürstengarnitur mit Papierhalter und WC-Bürste

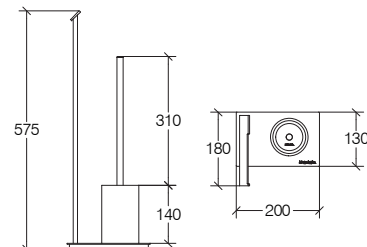

**Acciaio inox lucido**  
 Polished stainless steel  
 Acier inoxydable brillant  
 Polierter Edelstahl

**Porcellana**  
 Porcelaine  
 Porcelaine  
 Porzellan



.29

€ 253,00 - M



### Piantana portarotolo, portascopino e portasalvietta

5114.29

Toilet brush and towel set / Porte-rouleau sur pied avec balais et porte-serviettes / Kombi-Bürstengarnitur und Tuch - halter

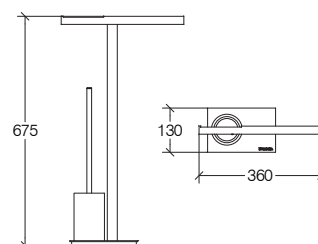
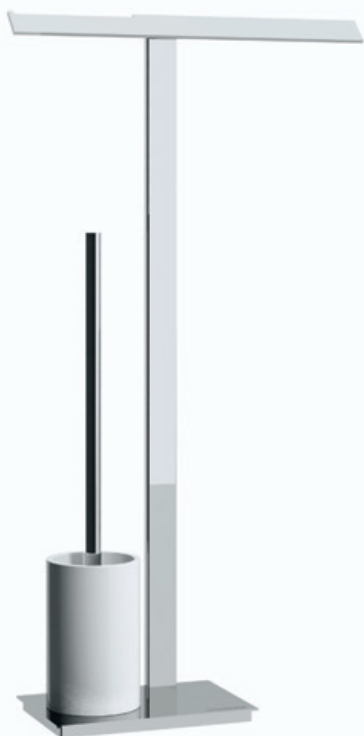

**Acciaio inox lucido**  
 Polished stainless steel  
 Acier inoxydable brillant  
 Polierter Edelstahl

**Porcellana**  
 Porcelaine  
 Porcelaine  
 Porzellan



.29

€ 276,00 - M



## Ranpin

### Piantana portasalviette

Towel holder stand / Porte-serviettes sur pied / Handtuchständer

5115.29

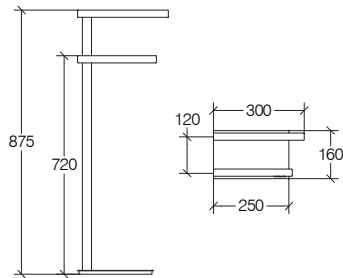
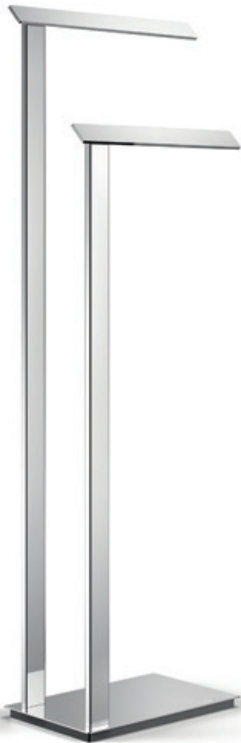

Acciaio inox lucido  
Polished stainless steel  
Acier inoxydable brillant  
Polierter Edelstahl



.29

€ 309,00 - L



**Piantana appendiabiti**

Hooks-stand / Porte-manteaux sur pied / Kleiderständer

**5126.29**

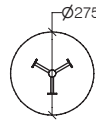
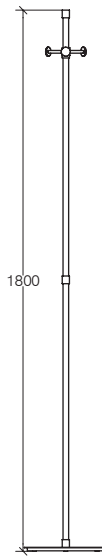

**Ottone cromato**  
 Chromed brass  
 Laiton chromé  
 Verchromtes Messing



.29

Combinabile con accessori di pagina 192-193  
 Matching with accessories see page 192-193  
 À équiper avec les accessoires page 192-193  
 Verwendbar mit Zubehör Seite 192-193

€ 216,00 - M

**Piantana appendiabiti**

Hooks-stand / Porte-manteaux sur pied / Kleiderständer

**51195.29**

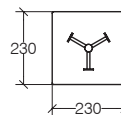
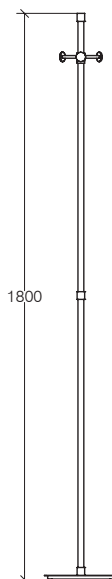

**Ottone cromato**  
 Chromed brass  
 Laiton chromé  
 Verchromtes Messing



.29

Combinabile con accessori di pagina 192-193  
 Matching with accessories see page 192-193  
 À équiper avec les accessoires page 192-193  
 Verwendbar mit Zubehör Seite 192-193

€ 232,00 - M

## Ranpin

### Piantana 3 portasalviette

Towel-stand, 3 arms / Porte-serviettes 3 barres sur pied / Handtuchständer mit 3 Arme

5120.29

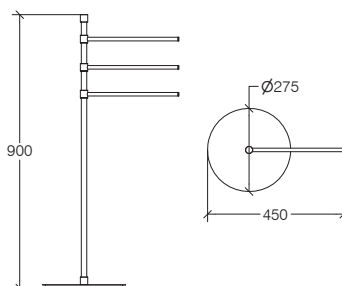

Ottone cromato  
Chromed brass  
Laiton chromé  
Verchromtes Messing



.29

€ 198,00 - M

### Piantana 3 portasalviette

Towel-stand, 3 arms / Porte-serviettes 3 barres sur pied / Handtuchständer mit 3 Arme

51191.29

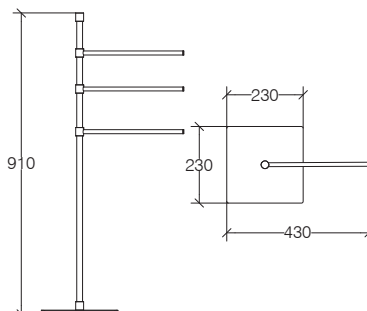

Ottone cromato  
Chromed brass  
Laiton chromé  
Verchromtes Messing



.29

€ 204,00 - M



**Piantana portarotolo e portascopino**

**5124.29**

Toilet paper and brush holder stand / Porte-rouleau et balai sur pied / Kombi-Bürstengarnitur mit Papierhalter und WC-Bürste

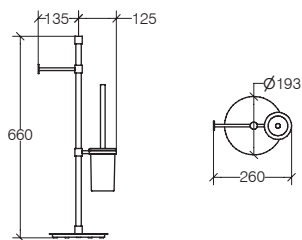

**Ottone cromato**  
Chromed brass  
Laiton chromé  
Verchromtes Messing



.29

€ 171,00 - M



**Piantana portarotolo e portascopino**

**51193.29**

Toilet paper and brush holder stand / Porte-rouleau et balai sur pied / Kombi-Bürstengarnitur mit Papierhalter und WC-Bürste

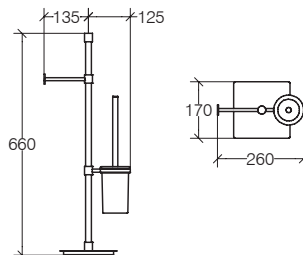

**Ottone cromato**  
Chromed brass  
Laiton chromé  
Verchromtes Messing



.29

€ 177,00 - M

## Ranpin

### Piantana bassa attrezzabile

51259.29

Customizable accessories stand, low / Porte-accessoires bas sur pied (à équiper) / Ständer Anpassbarer

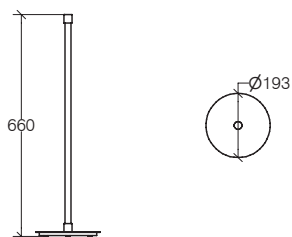

Ottone cromato  
Chromed brass  
Laiton chromé  
Verchromtes Messing



.29

Combinabile con accessori di pagina 192-193  
Matching with accessories see page 192-193  
À équiper avec les accessoires page 192-193  
Verwendbar mit Zubehör Seite 192-193

€ 122,00 - S

### Piantana bassa attrezzabile

51194.29

Customizable accessories stand, low / Porte-accessoires bas sur pied (à équiper) / Ständer Anpassbarer

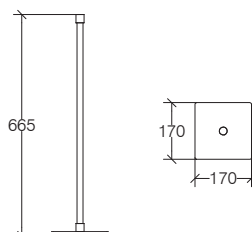

Ottone cromato  
Chromed brass  
Laiton chromé  
Verchromtes Messing



.29

Combinabile con accessori di pagina 192-193  
Matching with accessories see page 192-193  
À équiper avec les accessoires page 192-193  
Verwendbar mit Zubehör Seite 192-193

€ 122,00 - S

## Ranpin

### Piantana alta attrezzabile

Customizable accessories stand, tall / Porte-accessoires haut sur pied (à équiper) / Ständer Anpassbarer (groß)

51239.29

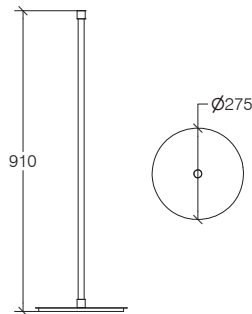

Ottone cromato  
Chromed brass  
Laiton chromé  
Verchromtes Messing



.29

Combinabile con accessori di pagina 192-193  
Matching with accessories see page 192-193  
À équiper avec les accessoires page 192-193  
Verwendbar mit Zubehör Seite 192-193

€ 149,00 - S



### Piantana alta attrezzabile

Customizable accessories stand, tall / Porte-accessoires haut sur pied (à équiper) / Ständer Anpassbarer (groß)

51192.29

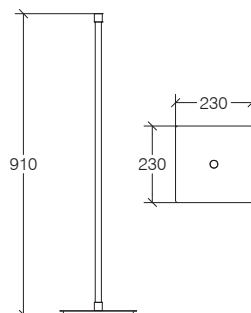

Ottone cromato  
Chromed brass  
Laiton chromé  
Verchromtes Messing



.29

Combinabile con accessori di pagina 192-193  
Matching with accessories see page 192-193  
À équiper avec les accessoires page 192-193  
Verwendbar mit Zubehör Seite 192-193

€ 149,00 - S

## Ranpin

### Portarotolo per barra

Toilet paper holder for rail / Porte-rouleau pour barre / Toilettenpapierhalter für Stange

5226.29

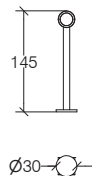

Ottone cromato  
Chromed brass  
Laiton chromé  
Verchromtes Messing



.29

€ 33,00

### Supporto scopino per barra

Toilet brush holder for rail / Support porte-balai pour barre / Halter für Stange zu Toilettenbürsten

52271.29

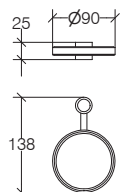

Ottone cromato  
Chromed brass  
Laiton chromé  
Verchromtes Messing



.29

€ 26,00

### Portasalvietta per barra

Towel rail for rail / Porte-serviettes pour barre / Handtuchhalter für Stange

5229.29

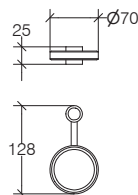

Ottone cromato  
Chromed brass  
Laiton chromé  
Verchromtes Messing



.29

€ 36,00

**Supporto per barra**

Single holder for rail / Support pour barre / Halter für Stange

**52241.29**

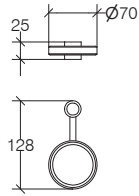

**Ottone cromato**  
Chromed brass  
Laiton chromé  
Verchromtes Messing



.29

€ 24,00



**Esempio di piantana attrezzata**

Example of accessoried stand / Porte-accessoires sur pied équipé (exemple) / Beispiel für Ständer mit Accessoires



**Ricambi / Spare parts / Pièces détachées / Ersatzteile**

<b>5113</b>	R2250055	Setola scopino - Toilet brush	<b>6,00</b>
	R2550203	Manico scopino 350 mm - Toilet brush handle 350 mm	<b>13,00</b>
	R2550069	Manico scopino 300 mm - Toilet brush handle 300 mm	<b>15,00</b>
	R529329	Manico scopino cromato con ciuffo - Toilet brush with chromed stick	<b>19,00</b>
	R2250054	Copri scopino - Toilet brush lid	<b>4,00</b>
<b>5114</b>	R2250055	Setola scopino - Toilet brush	<b>6,00</b>
	R2550203	Manico scopino 350 mm - Toilet brush handle 350 mm	<b>13,00</b>
	R2550069	Manico scopino 300 mm - Toilet brush handle 300 mm	<b>15,00</b>
	R539329	Manico scopino cromato con ciuffo - Toilet brush with chromed stick	<b>19,00</b>
	R2250054	Copri scopino - Toilet brush lid	<b>4,00</b>
<b>5120</b>	R2551202	Copribase Ø 275 mm - Chromed stand base cover Ø 275 mm	<b>61,00</b>
	R2251201	Anello PVC frenante - PVC braking ring	<b>2,00</b>
	R2251204	Gommino antiscivolo Ø 8 mm - Slip resistant rubber Ø 8 mm	<b>3,00</b>
<b>5124</b>	R2550069	Manico scopino 300 mm Toilet brush handle 300 mm	<b>15,00</b>
	R2652061	Vaso vetro acidato per porta scopino - Etched glass toilet brush	<b>16,00</b>
	R539329	Manico scopino cromato con ciuffo - Toilet brush with chromed stick	<b>19,00</b>
	R2250056	Copri scopino - Toilet brush lid	<b>4,00</b>
	R2250055	Setola scopino - Toilet brush	<b>6,00</b>
	R2255061	Guarnizione in silicone Ø 90 mm - Silicon gasket Ø 90 mm	<b>3,00</b>
	R2251201	Anello PVC frenante PVC braking ring	<b>2,00</b>
<b>5126</b>	R2551202	Copribase Ø 275 mm - Chromed stand base cover Ø 275 mm	<b>61,00</b>
	R2251201	Anello PVC frenante - PVC braking ring	<b>2,00</b>
	R51261	Kit ricambio appendiabiti art, 5126 - Hooks replacement for art, 5126	<b>24,00</b>
	R2251204	Gommino antiscivolo Ø 8 mm - Slip resistant rubber Ø 8 mm	<b>3,00</b>
	R2551209	Tubo lungo con terminale - Long tube with terminal	<b>55,00</b>
<b>51191</b>	R2551191	Copribase 230x230 mm - Chromed base cover 230x230 mm	<b>61,00</b>
	R2251201	Anello PVC frenante - PVC braking ring	<b>2,00</b>
	R2251204	Gommino antiscivolo Ø 8 mm - Slip resistant rubber Ø 8 mm	<b>3,00</b>

## Ricambi / Spare parts / Pièces détachées / Ersatzteile

<b>51192</b>	R2551191	Copribase 230x230 mm - Chromed base cover 230x230 mm	<b>61,00</b>
	R2251204	Gommino antiscivolo Ø 8 mm - Slip resistant rubber Ø 8 mm	<b>3,00</b>
<b>51193</b>	R2550069	Manico scopino 300 mm - Toilet brush handle 300 mm	<b>15,00</b>
	R2652061	Vaso vetro acidato per porta scopino - Etched glass toilet brush	<b>16,00</b>
	R539329	Manico scopino cromato con ciuffo - Toilet brush with chromed stick	<b>19,00</b>
	R2250056	Copri scopino - Toilet brush lid	<b>4,00</b>
	R2250055	Setola scopino - Toilet brush	<b>6,00</b>
	R2255061	Guarnizione in silicone Ø 90 mm - Silicon gasket Ø 90 mm	<b>3,00</b>
	R2251201	Anello PVC frenante - PVC braking ring	<b>2,00</b>
<b>51194</b>	R2551193	Copribase 170x170 mm - Chromed stand base cover 170x170 mm	<b>34,00</b>
	R2251204	Gommino antiscivolo Ø 8 mm - Slip resistant rubber Ø 8 mm	<b>3,00</b>
<b>51195</b>	R2551191	Copribase 230x230 mm - Chromed base cover 230x230 mm	<b>61,00</b>
	R2251201	Anello PVC frenante - PVC braking ring	<b>2,00</b>
	R51261	Kit ricambio appendiabiti art, 5126 - Hooks replacement for art, 5126	<b>24,00</b>
	R2251204	Gommino antiscivolo Ø 8 mm - Slip resistant rubber Ø 8 mm	<b>3,00</b>
<b>51239</b>	R2551202	Copribase Ø 275 mm - Chromed stand base cover Ø 275 mm	<b>61,00</b>
	R2251204	Gommino antiscivolo Ø 8 mm - Slip resistant rubber Ø 8 mm	<b>3,00</b>
<b>51259</b>	R2551242	Copribase Ø 193 mm - Chromed stand base cover Ø 193 mm	<b>34,00</b>
	R2251204	Gommino antiscivolo Ø 8 mm - Slip resistant rubber Ø 8 mm	<b>3,00</b>
<b>5111</b>	R2155062	Vaso porta scopino in porcellana - Porcelaine toilet brush holder	<b>20,00</b>
	R2250055	Setola scopino - Toilet brush	<b>6,00</b>
	R2250054	Copriscopino Ø 67 - Toilet brush lid Ø 67	<b>4,00</b>
<b>51111</b>	R2155062	Vaso porta scopino in porcellana - Porcelaine toilet brush holder	<b>20,00</b>
	R2250055	Setola scopino - Toilet brush	<b>6,00</b>
	R2250054	Copriscopino Ø 67 - Toilet brush lid Ø 67	<b>4,00</b>



# mobili & contenitori

*Furniture and Cabinets / Meubles et Armoires / Schränke und Möbel*

## **Mobili componibili / 200**

*Modular furniture / Meubles à éléments modulaires / Modulare Möbel*

## **Piani top per lavabi / 214**

*Tops for tabletop washbasins / Plans pour vasques à poser / Platte zum Aufsatzwaschbecken*

## **Supporti per lavabo / 222**

*Wash-basins supports / Supports pour lavabo / Halterungen zum Waschtisch*

## **Colonne / 224**

*Columns / Colonnes / Hochschränke*

## **Pensili / 236**

*Wall units / Meubles hauts / Hängeschränke*

## **Basi su ruote / 240**

*Drawer units on castors / Meubles sur roulettes / Schränke auf Rollen*







## Grela abaco

### Grela 1200 mm

**Con lavabo incassato**  
*built-in washbasins*  
*lavabo encastré*  
*seinbauwaschbecken*

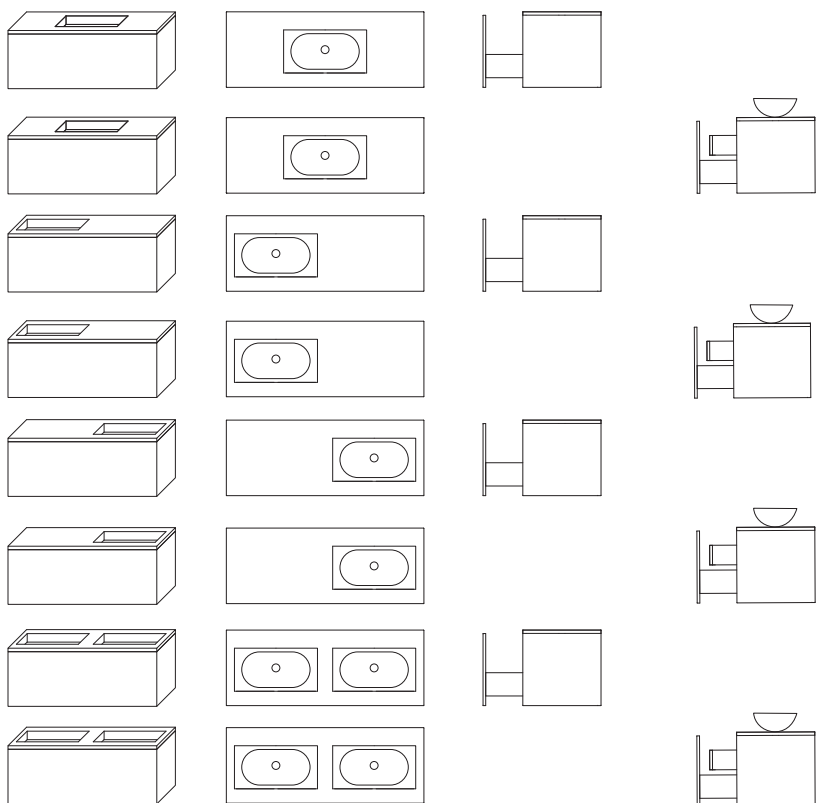

### Grela 1200 mm

**Con lavabo appoggio**  
*countertop washbasins*  
*vasque à poser*  
*aufsatzwaschbecken*

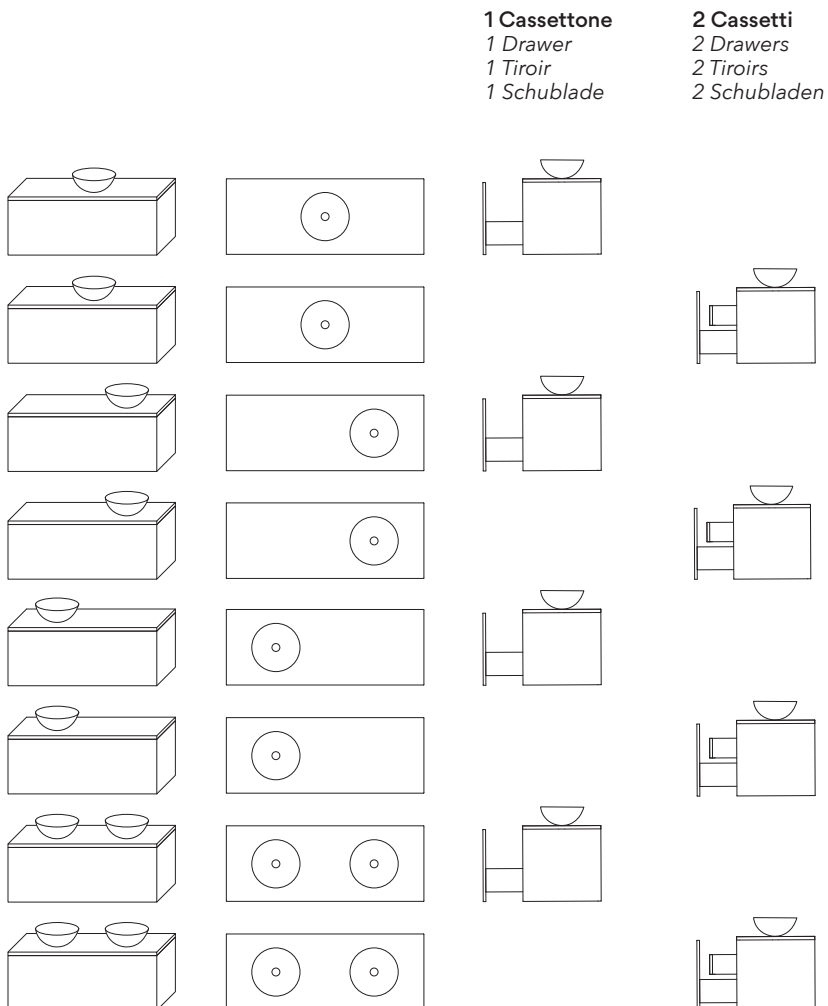

**Grela abaco**

**Grela 900 mm**

**1 Cassettone**  
1 Drawer  
1 Tiroir  
1 Schublade

**2 Cassetti**  
2 Drawers  
2 Tiroirs  
2 Schubladen

**Con lavabo incassato**  
*built-in washbasins*  
*lavabo encastré*  
*seinbauwaschbecken*

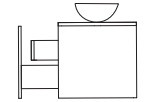
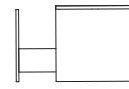
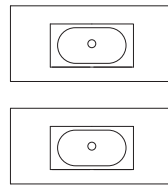
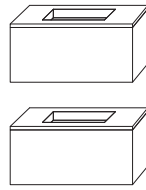

**Con lavabo appoggio**  
*countertop washbasins*  
*vasque à poser*  
*aufsatzwaschbecken*

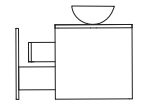
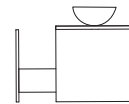
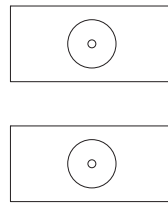
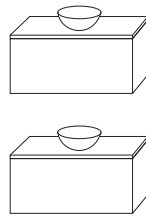

**Grela 600 mm**

**1 Cassettone**  
1 Drawer  
1 Tiroir  
1 Schublade

**2 Cassetti**  
2 Drawers  
2 Tiroirs  
2 Schubladen

**Con lavabo incassato**  
*built-in washbasins*  
*lavabo encastré*  
*seinbauwaschbecken*

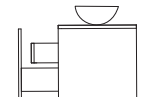
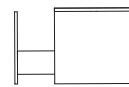
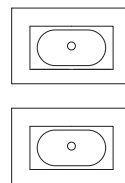
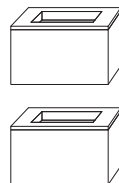

**Con lavabo appoggio**  
*countertop washbasins*  
*vasque à poser*  
*aufsatzwaschbecken*

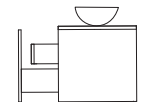
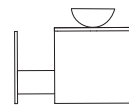
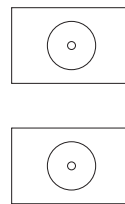
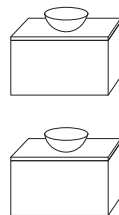

**Grela 430 mm**

**1 Cassettone**  
1 Drawer  
1 Tiroir  
1 Schublade

**Con lavabo incassato**  
*built-in washbasins*  
*lavabo encastré*  
*seinbauwaschbecken*

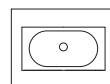
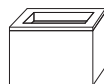

Grela



Mobile componibile con lavabo ad incasso  
Modular furniture with built-in washbasin  
Meubles à éléments modulaires avec lavabo encastré  
Modulare Möbel mit integriertem Waschbecken

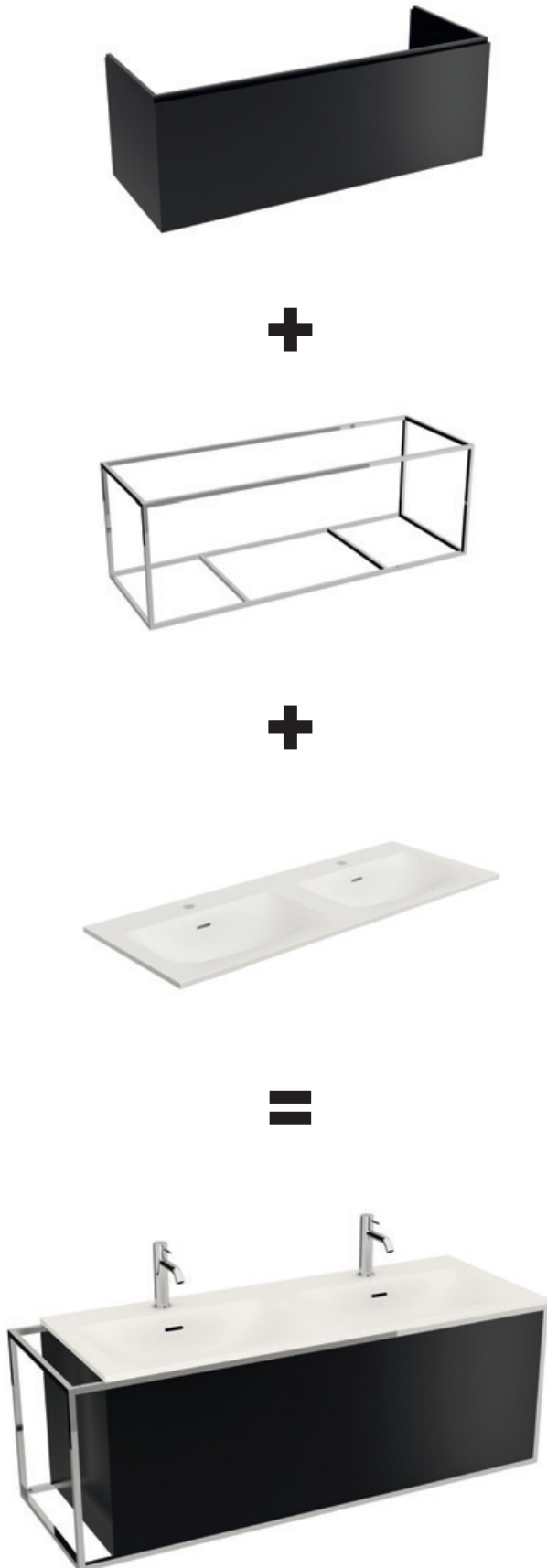

Mobile componibile con lavabo da appoggio  
Modular furniture with countertop washbasins  
Meubles à éléments modulaires avec vasque à poser  
Modulare Möbel mit Aufsatzbecken

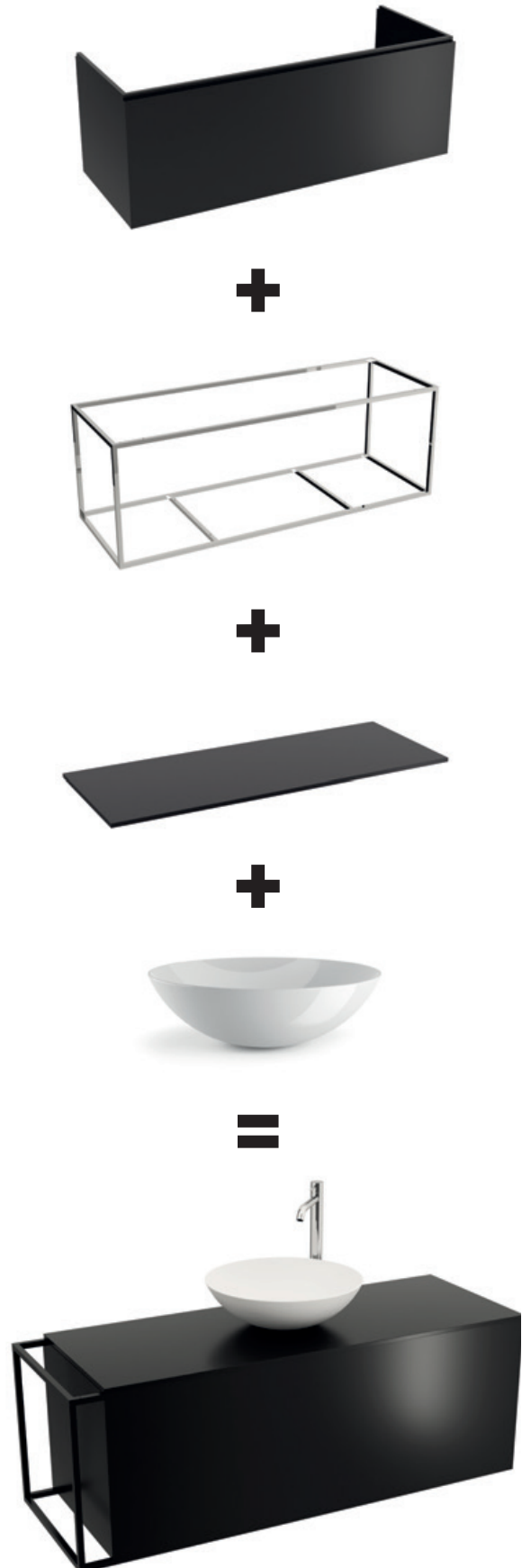

**Grela**

<b>COD.</b>	Descrizione / Description / Description / Beschreibung	<b>L €</b>	<b>O €</b>	<b>N €</b>
<b>8280.nn</b>	<b>Base sospesa 1200 mm con un cassettone push-pull</b> Base unit 1 drawer push-pull Meuble bas avec 1 tiroir push-pull Unterschrank 1 Schublade push-pull	676,00 - L	619,00 - L	490,00 - L
<b>8280DX.nn</b>	<b>Base sospesa 1200 mm con un cassettone push-pull per vasca a destra</b> Base unit 1 drawer push-pull for right sink Meuble bas avec 1 tiroir push-pull pour évier droit Unterschrank 1 Schublade push-pull für rechtem Waschbecken	676,00 - L	619,00 - L	490,00 - L
<b>8280SX.nn</b>	<b>Base sospesa 1200 mm con un cassettone push-pull per vasca a sinistra</b> Base unit 1 drawer push-pull for left sink Meuble bas avec 1 tiroir push-pull pour évier gauche Unterschrank 1 Schublade push-pull für linke Waschbecken	676,00 - L	619,00 - L	490,00 - L
<b>82801.nn</b>	<b>Base sospesa 1200 mm con un cassettone push-pull + cassetto interno</b> Base unit 1 drawer push-pull and internal drawer Meuble bas avec 1 tiroir push-pull et tiroir intérieur Unterschrank 1 Schublade push-pull und Innenschublade	850,00 - L	793,00 - L	665,00 - L
<b>82801DX.nn</b>	<b>Base sospesa 1200 mm con un cassettone push-pull + cassetto interno per vasca a destra</b> Base unit 1 drawer push-pull and internal drawer for right sink Meuble bas avec 1 tiroir push-pull et tiroir intérieur pour évier droit Unterschrank 1 Schublade push-pull und Innenschublade für rechtem Waschbecken	850,00 - L	793,00 - L	665,00 - L
<b>82801SX.nn</b>	<b>Base sospesa 1200 mm con un cassettone push-pull + cassetto interno per vasca a sinistra</b> Base unit 1 drawer push-pull and internal drawer for left sink Meuble bas avec 1 tiroir push-pull et tiroir intérieur pour évier gauche Unterschrank 1 Schublade push-pull und Innenschublade für linke Waschbecken	850,00 - L	793,00 - L	665,00 - L
<b>82802.nn</b>	<b>Base sospesa per doppio lavabo 1200 mm con un cassettone push-pull</b> Base unit for 2 washbasins 1 drawer push-pull Meuble bas avec pour 2 lavabos 1 tiroir push-pull Unterschrank für 2 Waschbecken 1 Schublade push-pull	676,00 - L	619,00 - L	490,00 - L
<b>82803.nn</b>	<b>Base sospesa per doppio lavabo 1200 mm con un cassettone push-pull + cassetto interno</b> Base unit for 2 washbasins 1 drawer push-pull and internal drawer Meuble bas avec pour 2 lavabos 1 tiroir push-pull et tiroir intérieur Unterschrank 1 Schublade push-pull und Innenschublade	850,00 - L	793,00 - L	665,00 - L



**L** **Laccato lucido**  
Glossy lacquered  
Laqué brillant  
Glänzend Lackiert

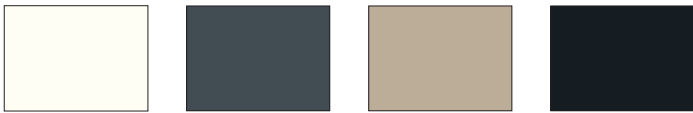

.09L .17L .21L .22L

**O** **Laccato opaco**  
Mat lacquered  
Laqué mat  
Matt Lackiert



.09 .17 .21 .22

**N** **Laminato**  
Laminated  
Stratifié  
Holzlaminat



.03 .01 .02 .05

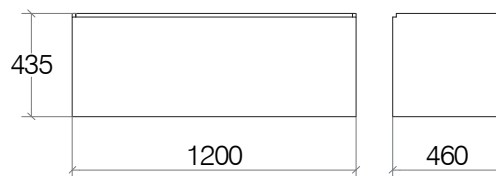

**Telaio per base sospesa 1200 mm**

Frame for door 1200 mm / Structure pour meuble suspendu 1200 mm / Rahmen für Schrank 1200 mm

**8281.nn**

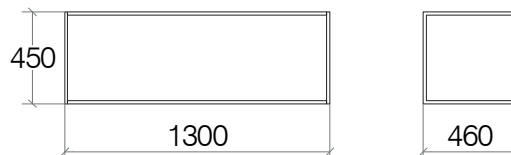
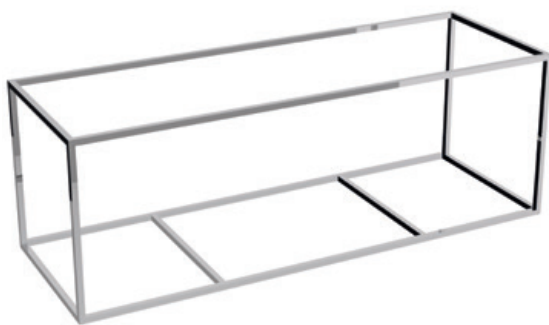

**Acciaio verniciato**  
Painted steel  
Acier laqué  
Lackiertem Stahl



€ 510,00

**Acciaio inox lucido**  
Polished stainless steel  
Acier inoxydable brillant  
Poliert Edelstahl



€ 592,00

**Acciaio inox nickel nero**  
Black nickel stainless steel  
Acier inoxydable nickel  
Edelstahl Nickel Schwarz



€ 799,00

**Grela**

**Lavabo a una vasca con foro rubinetto 1200 mm**

Washbasin with mixer hole 1200 mm / Lavabo avec perçage de robinetterie 1200 mm  
Waschbecken mit Armaturloch 1200 mm

**53573.26**

€ 480,00

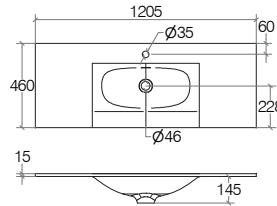

**Mineralmarmo opaco**  
Matt mineral marble  
Minéral marbre mat  
Mineralguss matt

**Lavabo a una vasca a destra con foro rubinetto 1200 mm**

Washbasin with mixer hole with right sink 1200 mm / Lavabo avec perçage de robinetterie avec vasque à droit 1200 mm  
Waschbecken mit Armaturloch mit rechtem Waschbecken 1200 mm

**53573DX.26**

€ 480,00

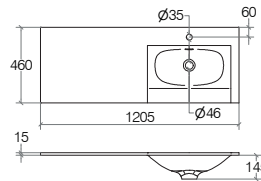

**Mineralmarmo opaco**  
Matt mineral marble  
Minéral marbre mat  
Mineralguss matt

**Lavabo a una vasca a sinistra con foro rubinetto 1200 mm**

Washbasin with mixer hole with left sink 1200 mm / Lavabo avec perçage de robinetterie avec vasque à gauche 1200 mm  
Waschbecken mit Armaturloch mit linkem Waschbecken 1200 mm

**53573SX.26**

€ 480,00

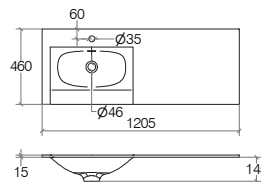

**Mineralmarmo opaco**  
Matt mineral marble  
Minéral marbre mat  
Mineralguss matt

**Lavabo a due vasche con foro rubinetto 1200 mm**

Washbasin with mixer hole with double sink 1200 mm / Lavabo avec perçage de robinetterie avec double vasque 1200 mm  
Waschbecken mit Armaturloch mit doppelt Waschbecken 1200 mm

**535732.26**

€ 538,00

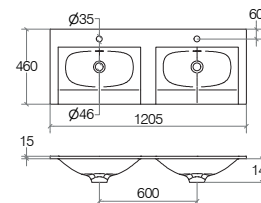

**Mineralmarmo opaco**  
Matt mineral marble  
Minéral marbre mat  
Mineralguss matt

**Lavabo a una vasca con foro rubinetto 1200 mm**

Washbasin with mixer hole 1200 mm / Lavabo avec perçage de robinetterie 1200 mm  
Waschbecken mit Armaturloch 1200 mm

**53576.09**

€ 527,00

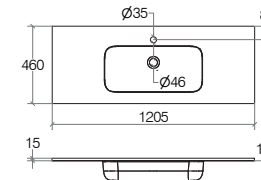

**Mineralmarmo lucido**  
Glossy solid surface  
Minéral marbre brillant  
Glänzend Mineralguss

**Lavabo a due vasche con foro rubinetto 1200 mm**

Washbasin with mixer hole with double sink 1200 mm / Lavabo avec perçage de robinetterie avec double vasque 1200 mm  
Waschbecken mit Armaturloch mit doppelt Waschbecken 1200 mm

**535762.09**

€ 591,00

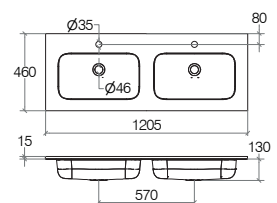

**Mineralmarmo lucido**  
Glossy solid surface  
Minéral marbre brillant  
Glänzend Mineralguss



COD.	Descrizione / Description / Description / Beschreibung	L €	O €	N €
<b>8282.nn</b>	<b>Top per base sospesa 1200 mm</b> Top for drawer unit 1200 mm Plan pour meuble 1200 mm Platte für Schrank 1200 mm	231,00 - L	220,00 - L	132,00 - L

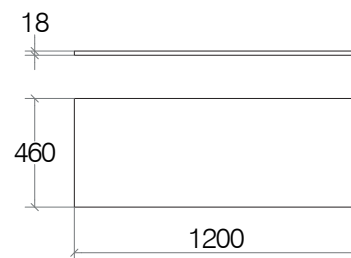

ITALY

<b>L</b>	<b>Laccato lucido</b> <i>Glossy lacquered</i> <i>Laqué brillant</i> <i>Glänzend Lackiert</i>						
		.09L	.17L	.21L	.22L		
		<b>O</b>	<b>Laccato opaco</b> <i>Mat lacquered</i> <i>Laqué mat</i> <i>Matt Lackiert</i>				
				.09	.17	.21	.22
<b>N</b>	<b>Laminato</b> <i>Laminated</i> <i>Stratifié</i> <i>Holzlaminat</i>						
		.03	.01	.02	.05		



**Per tutti i lavabi in appoggio vedi pag. 252 a 261**

For all countertop washbasin see pages: 252-261 / Pour tous les vasques à poser voir pages : 252-261 / Für Aufsatzbecken siehe Seiten: 252-261

**1 Cassettone**

1 Drawer / 1 Tiroir / 1 Schublad



**2 Cassetti**

2 Drawers / 2 Tiroirs / 2 Schubladen



**Grela**

<b>COD.</b>	Descrizione / Description / Description / Beschreibung	<b>L €</b>	<b>O €</b>	<b>N €</b>
<b>8260.nn</b>	<b>Base sospesa 900 mm con un cassettone push-pull</b> Base unit 1 drawer push-pull Meuble bas avec 1 tiroir push-pull Unterschrank 1 Schublade push-pull	613,00 - L	561,00 - L	457,00 - L
<b>82601.nn</b>	<b>Base sospesa 900 mm con un cassettone push-pull + cassetto interno</b> Base unit 1 drawer push-pull and internal drawer Meuble bas avec 1 tiroir push-pull et tiroir intérieur Unterschrank 1 Schublade push-pull und Innenschublade	781,00 - L	729,00 - L	625,00 - L

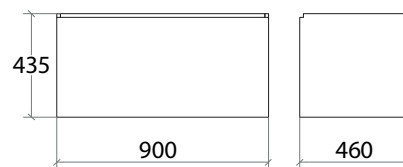
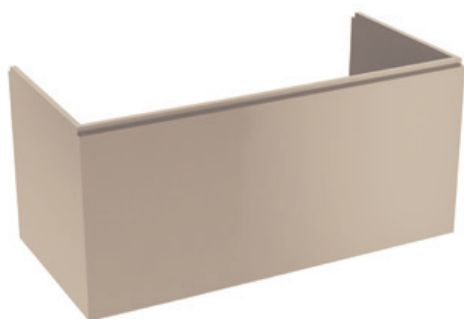

<b>L</b>	<b>Laccato lucido</b> Glossy lacquered Laqué brillant Glänzend Lackiert				
		<b>.09L</b>	<b>.17L</b>	<b>.21L</b>	<b>.22L</b>

<b>O</b>	<b>Laccato opaco</b> Mat lacquered Laqué mat Matt Lackiert				
		<b>.09</b>	<b>.17</b>	<b>.21</b>	<b>.22</b>

<b>N</b>	<b>Laminato</b> Laminated Stratifié Holzlaminat				
		<b>.03</b>	<b>.01</b>	<b>.02</b>	<b>.05</b>

**Telaio per base sospesa 900 mm**

**8261.nn**

Frame for unit / Structure pour meuble suspendu / Rahmen für Schrank

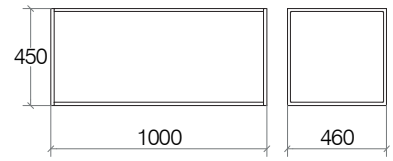

**Acciaio verniciato**  
Painted steel  
Acier laqué  
Lackiertem Stahl

**Acciaio inox lucido**  
Polished stainless steel  
Acier inoxydable brillant  
Poliert Edelstahl

**Acciaio inox nickel nero**  
Black nickel stainless steel  
Acier inoxydable nickel  
Edelstahl Nickel Schwarz



.09

.18

.29

.33

€ 439,00

€ 531,00

€ 643,00

**Lavabo a una vasca con foro rubinetto 900 mm**

**53572.26**

Washbasin with mixer hole 900 mm / Lavabo avec perçage de robinetterie 900 mm  
Waschbecken mit Armaturloch 900 mm

€ 327,00

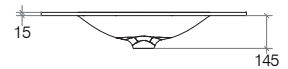
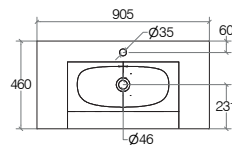

**Mineralmarmo opaco**  
Matt mineral marble  
Minéral marbre mat  
Mineralguss matt

**Lavabo a una vasca con foro rubinetto 900 mm**

**53575.09**

Washbasin with mixer hole 900 mm / Lavabo avec perçage de robinetterie 900 mm  
Waschbecken mit Armaturloch 900 mm

€ 359,00

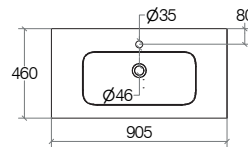

**Mineralmarmo lucido**  
Glossy solid surface  
Minéral marbre brillant  
Glänzend Mineralguss

COD.	Descrizione / Description / Description / Beschreibung	L €	O €	N €
<b>8262.nn</b>	<b>Top per base sospesa 900 mm</b> Top for drawer unit 900 mm Plan pour meuble 900 mm Platte für Schrank 900 mm	202,00 - L	194,00 - L	123,00 - L

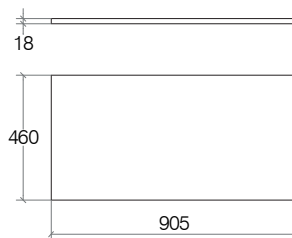

**Grela**

<b>COD.</b>	Misure / Measure / Mesure / Maß	<b>L €</b>	<b>O €</b>	<b>N €</b>
<b>8240.nn</b>	<b>Base sospesa 600 mm con un cassettone push-pull</b> Base unit 1 drawer push-pull Meuble bas avec 1 tiroir push-pull Unterschrank 1 Schublade push-pull	545,00 - L	499,00 - L	418,00 - L
<b>82401.nn</b>	<b>Base sospesa 600 mm con un cassettone push-pull + cassetto interno</b> Base unit 1 drawer push-pull and internal drawer Meuble bas avec 1 tiroir push-pull et tiroir intérieur Unterschrank 1 Schublade push-pull und Innenschublade	701,00 - L	655,00 - L	574,00 - L

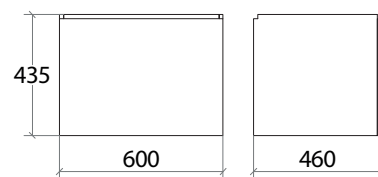
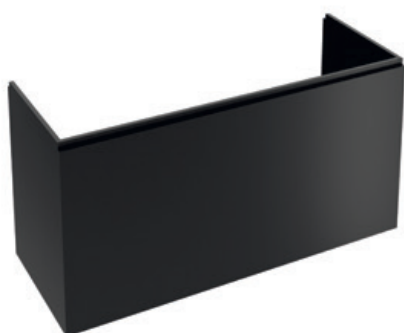

**L** **Laccato lucido**  
Glossy lacquered  
Laqué brillant  
Glänzend Lackiert

<b>.09L</b>	<b>.17L</b>	<b>.21L</b>	<b>.22L</b>

**O** **Laccato opaco**  
Mat lacquered  
Laqué mat  
Matt Lackiert

<b>.09</b>	<b>.17</b>	<b>.21</b>	<b>.22</b>

**N** **Laminato**  
Laminated  
Stratifié  
Holzlaminat

<b>.03</b>	<b>.01</b>	<b>.02</b>	<b>.05</b>

**Telaio per base sospesa 600 mm**

Frame for unit / Structure pour meuble suspendu / Rahmen für Schrank

**8241.nn**

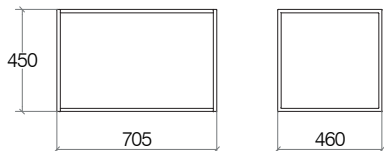
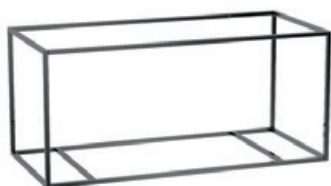

**Acciaio verniciato**  
Painted steel  
Acier laqué  
Lackiertem Stahl



.09

€ 368,00

**Acciaio inox lucido**  
Polished stainless steel  
Acier inoxydable brillant  
Poliert Edelstahl



.18



.29

€ 470,00

**Acciaio inox nickel nero**  
Black nickel stainless steel  
Acier inoxydable nickel  
Edelstahl Nickel Schwarz



.33

€ 530,00

**Lavabo a una vasca con foro rubinetetto 600 mm**

Washbasin with mixer hole 600 mm / Lavabo avec perçage de robinetterie 600 mm  
Waschbecken mit Armaturloch 600 mm

**53571.26**

€ 245,00

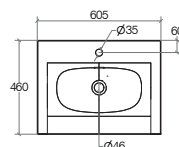

**Mineralmarmo opaco**  
Matt mineral marble  
Minéral marbre mat  
Mineralguss matt

**Lavabo a una vasca con foro rubinetetto 600 mm**

Washbasin with mixer hole 600 mm / Lavabo avec perçage de robinetterie 600 mm  
Waschbecken mit Armaturloch 600 mm

**53574.09**

€ 265,00

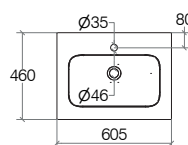

**Mineralmarmo lucido**  
Glossy solid surface  
Minéral marbre brillant  
Glänzend Mineralguss

COD.	Descrizione / Description / Description / Beschreibung	L €	O €	N €
<b>8242.nn</b>	<b>Top per base sospesa 600 mm</b> Top for drawer unit 600 mm Plan pour meuble 600 mm Platte für Schrank 600 mm	174,00 - L	167,00 - L	114,00 - L

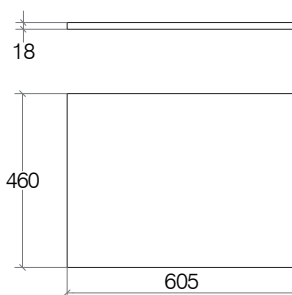

**Grela**

**Base sospesa 430 mm con anta push-pull**

**8220.nn**

Base unit 430mm with a push pull door  
 Meuble bas 430 mm avec porte push-pull  
 Unterschrank 430 mm mit einer Push-Pull-Tür

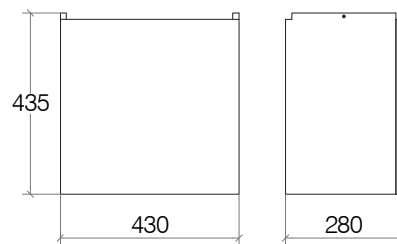

<b>L</b>	<b>Laccato lucido</b> Glossy lacquered Laqué brillant Glänzend Lackiert					€ 329,00 - L			
		.09L	.17L	.21L	.22L				
		<b>O</b>	<b>Laccato opaco</b> Mat lacquered Laqué mat Matt Lackiert						€ 293,00 - L
				.09	.17		.21	.22	
<b>N</b>	<b>Laminato</b> Laminated Stratifié Holzlaminat					€ 244,00 - L			
		.03	.01	.02	.05				

**Lavabo con foro rubinetto in mineralmarmo opaco**

**53570**

Washbasin with mixer hole for base unit / Lavabo avec perçage de robinetterie pour meuble  
 Waschbecken mit Armaturloch für Schrank

€ 194,00

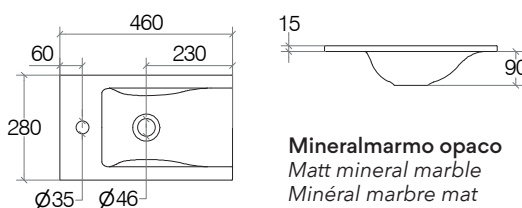

**Mineralmarmo opaco**  
 Matt mineral marble  
 Minéral marbre mat  
 Mineralguss matt

**Telaio per base sospesa 430 mm**

Frame for unit / Structure pour meuble suspendu / Rahmen für Schrank

**8221.nn**

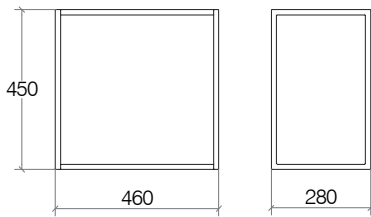

**Acciaio verniciato**  
Painted steel  
Acier laqué  
Lackiertem Stahl



.09 .18

€ 327,00

**Acciaio inox lucido**  
Polished stainless steel  
Acier inoxydable brillant  
Poliert Edelstahl



.29

€ 378,00

**Acciaio inox nickel nero**  
Black nickel stainless steel  
Acier inoxydable nickel  
Edelstahl Nickel Schwarz



.33

€ 439,00



**Tasca in tessuto con clip per attacco a telaio 'GRELA'**

Pouch with clip for 'GRELA' wireframe / Pochette avec clip pour structure 'GRELA' / Tasche mit Klipp für Halterung 'GRELA'

**7218.nn**

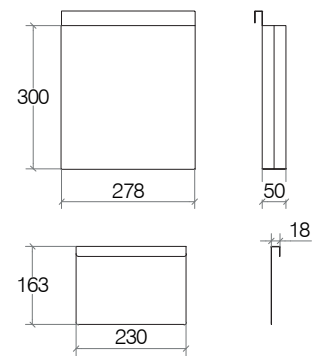

.09



.29



.32

€ 32,00



**De sora**

**Piano Top, spessore 57 mm, profondità 435 mm, con staffe a vista in acciaio.**

Top shelf with visible steel brackets / Plan avec supports visibles en acier / Oberstes Regal mit sichtbaren Stahlbügel

<b>COD.</b>	Misure / Measure / Dimensions / Maß	<b>L €</b>	<b>O €</b>	<b>N €</b>
<b>82941.nn</b>	800 ÷ 1190 mm	407,00 - L	396,00 - L	341,00 - L
<b>82942.nn</b>	1200 ÷ 1590 mm	471,00 - L	457,00 - L	389,00 - L
<b>82943.nn</b>	1600 ÷ 2400 mm	563,00 - L	545,00 - L	450,00 - L

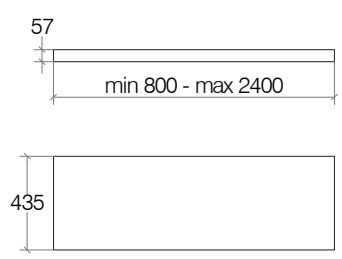

**Per tutti i lavabi in appoggio vedi pag. 252 a 261**

For all countertop washbasin see pages: 252-261  
 Pour tous les vasques à poser voir pages : 252-261  
 Für Aufsatzbecken siehe Seiten: 252-261

<b>L</b> Laccato lucido Glossy lacquered Laqué brillant Glänzend Lackiert					
	.09L	.17L	.21L	.22L	
	<b>O</b> Laccato opaco Mat lacquered Laqué mat Matt Lackiert				
		.09	.17	.21	.22
<b>N</b> Laminato Laminated Stratifié Holzlaminat					
		.03	.01	.02	.05



**Piano Gobba, spessore 38 mm, profondità 435 mm, con staffe a vista in acciaio.**

Top shelf with visible steel brackets / Plan avec supports visibles en acier / Oberstes Regal mit sichtbaren Stahlbügel

COD.	Misure / Measure / Dimensions / Maß	L €	O €	N €
<b>82951DX.nn</b>	800 ÷ 1190 mm	726,00 - L	668,00 - L	538,00 - L
<b>82951SX.nn</b>	800 ÷ 1190 mm	726,00 - L	668,00 - L	538,00 - L
<b>82952DX.nn</b>	1200 ÷ 1590 mm	818,00 - L	759,00 - L	612,00 - L
<b>82952SX.nn</b>	1200 ÷ 1590 mm	818,00 - L	759,00 - L	612,00 - L
<b>82953DX.nn</b>	1600 ÷ 2400 mm	968,00 - L	905,00 - L	727,00 - L
<b>82953SX.nn</b>	1600 ÷ 2400 mm	968,00 - L	905,00 - L	727,00 - L

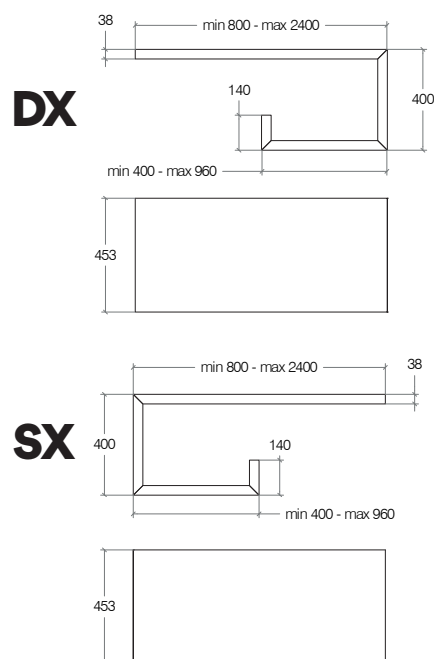

**la misura della mensola inferiore è sempre pari al 40% della mensola superiore (non oltre le dimensioni indicate)**

The size of the lower shelf is always equal to 40% of the upper shelf (no more than the dimensions indicated)

La dimensions de l'étagère inférieure est toujours égale à 40% de l'étagère supérieure (pas plus que les dimensions indiquées)

Die Größe des unteren Regals entspricht immer 40% des oberen Regals (nicht mehr als die angegebenen Dimensionen)

**L** **Laccato lucido**  
Glossy lacquered  
Laqué brillant  
Glänzend Lackiert

.09L	.17L	.21L	.22L

**O** **Laccato opaco**  
Mat lacquered  
Laqué mat  
Matt Lackiert

.09	.17	.21	.22

**N** **Laminato**  
Laminated  
Stratifié  
Holzlaminat

.03	.01	.02	.05



# Canavera

Mobili & Contenitori / Furniture and Cabinets / Meubles et Armoires / Schränke



## Canavera

### Supporto per lavabo 700 mm

Wash-table unit 700 mm / Meuble pour lavabo 700 mm / Waschtisch 700 mm

81107.03

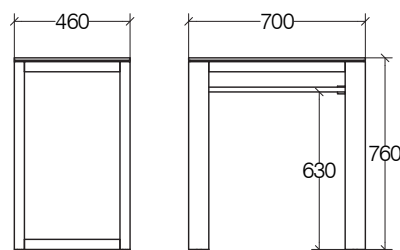

**Bambù verniciato**  
Vernished Bamboo  
Bambou verni  
Zinnobambus



.03



€ 519,00 - M

### Supporto per lavabo 1000 mm

Wash-table unit 1000 mm / Meuble pour lavabo 1000 mm / Waschtisch 1000 mm

81110.03

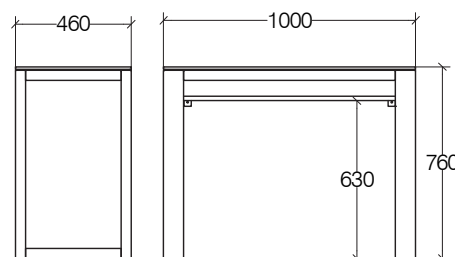

**Bambù verniciato**  
Vernished Bamboo  
Bambou verni  
Zinnobambus



.03



€ 574,00 - M

**Supporto per lavabo 1300 mm**

Wash-table unit 1300 mm / Meuble pour lavabo 1300 mm / Waschtisch 1300 mm

**81113.03**

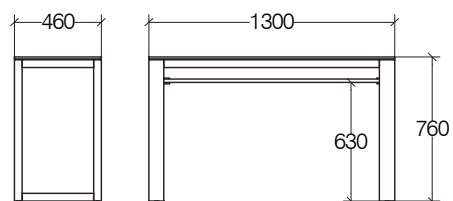

**Bambù verniciato**  
Vernished Bamboo  
Bambou verni  
Zinnobambus



.03



€ 656,00 - M

**Panca**

Bench / Banc / Bank

**81120.03**

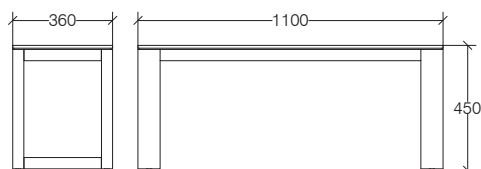

**Bambù verniciato**  
Vernished Bamboo  
Bambou verni  
Zinnobambus



.03



€ 386,00 - M

## Canavera

### Sgabello

Stool / Tabouret / Hocker

81119.03

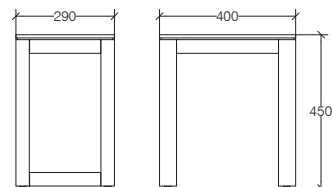

**Bambù verniciato**  
Vernished Bamboo  
Bambou verni  
Zinnobambus



.03

€ 221,00 - M

ITALY

### Specchio contenitore reversibile con ripiani in vetro

Reversible container mirror with glass shelves / Armoire de toilette reversible avec miroir  
Spiegelbehälter mit Glasablage Wechselseitige Montage

81141.03

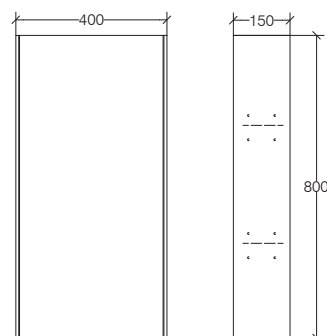

**Bambù verniciato**  
Vernished Bamboo  
Bambou verni  
Zinnobambus



.03

€ 347,00 - M

ITALY

**Specchio con cornice verticale o orizzontale**

Mirror vertical or horizontal with frame / Miroir vertical ou horizontal, avec cadre  
Spiegel mit Rahmen, senkrecht oder waagrecht

**81140.03**

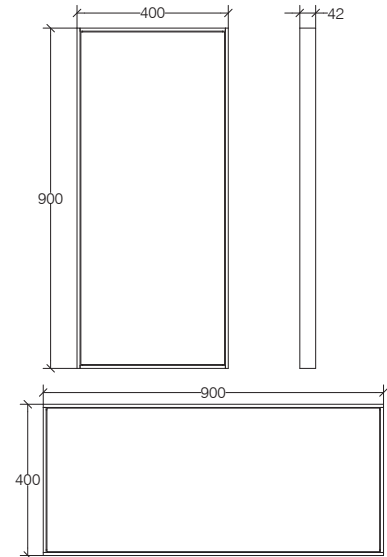

**Bambù verniciato**  
*Vernished Bamboo*  
*Bambou verni*  
*Zinnobambus*



.03

## Goto

### Supporto vasca con foro rubinetto e tappo

66213.29

Wall support, with tap hole with free waste / Support avec perçage de robinetterie  
Wandhalterung für Becken mit Hahnloch

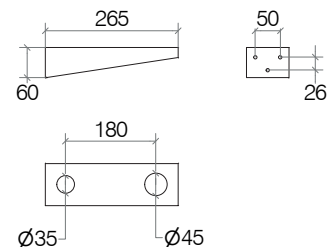

Acciaio inox  
Stainless steel  
Acier inoxydable  
Rostfreier stahl



.29

Combinabile con Serie Busi e Cane  
Matching with Busi e Cane collection  
À équiper avec collection Busi e Cane  
Verwendbar mit Kollektion Busi e Cane

€ 81,00 - S

### Supporto vasca con foro rubinetto e tappo

66214.29

Wall support, with tap hole with free waste / Support avec perçage de robinetterie  
Wandhalterung für Becken mit Hahnloch

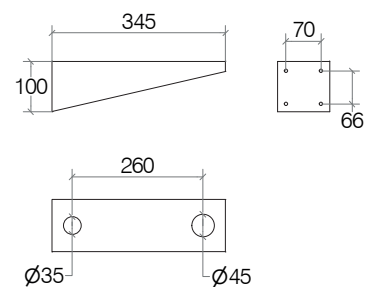

Acciaio inox  
Stainless steel  
Acier inoxydable  
Rostfreier stahl



.29

Combinabile con Serie Busi e Cane  
Matching with Busi e Cane collection  
À équiper avec collection Busi e Cane  
Verwendbar mit Kollektion Busi e Cane

€ 102,00 - S





# colonne

Columns / Colonne / Hochschränken

## IT

### Ciacole:

le chiacchiere tra comari, quelle che s'impicciano più degli affari altrui che dei propri.

La collezione è composta da una serie di mobiletti in alluminio verniciato a giorno o con anta a specchio.

Alluminio verniciato bianco, antracite o nero gofrato

## EN

### Ciacole:

*chatter between women, those who mind other people's business more than their own.*

*The collection consists of a range of cabinets in painted aluminium, unframed or with a mirror door.*

*Embossed white, charcoal-grey or black painted aluminium*

## FR

### Ciacole :

*bavardages entre commères, celles qui s'intéressent aux affaires des autres.*

*La collection se compose d'une série de meubles en aluminium verni, ouverts ou avec panneau miroir.*

*Aluminium verni blanc, anthracite ou noir gaufré*

## DE

### Ciacole:

*ein Schwätzchen unter Klatschanten, jene also, die sich mehr in die Angelegenheiten anderer einmischen, als in die eigenen.*

*Die Kollektion besteht aus einer Reihe von kleinen Möbelstücken aus lackiertem Aluminium, die entweder vorne offen sind oder eine Spiegeltür haben.*

*Weiß, anthrazit oder schwarz lackiertes, gaufriertes Aluminium*



# Ciacole

## Colonna girevole con specchio

Swivel cabinet with mirror / Colonne pivotante avec miroir / Drehbarer Schrank mit Spiegel

8040.nn

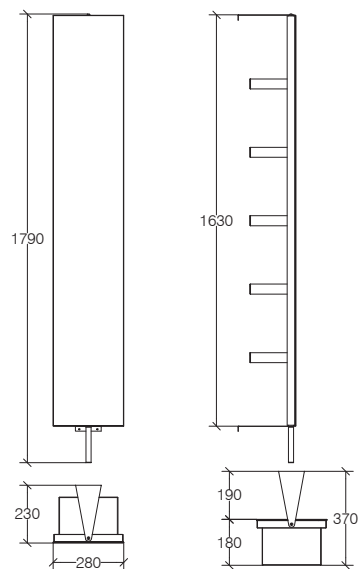

Alluminio verniciato  
Painted aluminium  
Aluminium laqué  
Lackiertem Aluminium

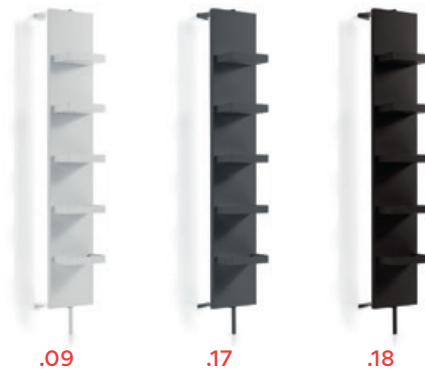

€ 419,00 - M

**Colonna girevole con specchio**

Swivel cabinet with mirror / Colonne pivotante avec miroir / Drehbarer Schrank mit Spiegel

8059.nn

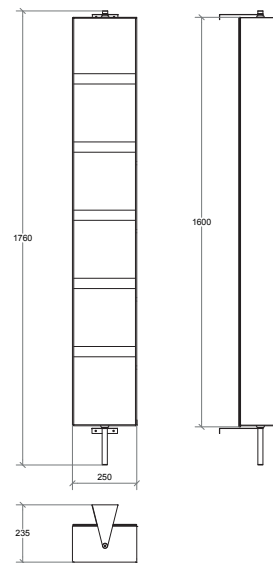

Alluminio verniciato  
Painted aluminium  
Aluminium laqué  
Lackiertem Aluminium



.09



.17



.18

€ 500,00 - M

## Ciacole

### Colonna con anta a specchio

Cabinet with mirror door / Colonne avec porte miroir / Schrank mit Spiegeltür

8052.nn

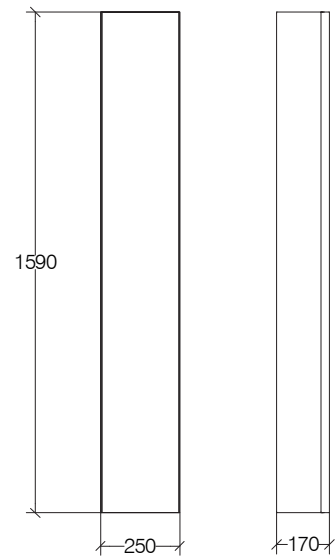

Alluminio verniciato  
Painted aluminium  
Aluminium laqué  
Lackiertem Aluminium



.09

.17

.18

€ 513,00 - L

**Colonna con anta a specchio e ripiani in vetro**

Cabinet with mirror door and glass shelves  
Colonne avec porte miroir et étagère en verre  
Schrank mit Spiegeltür und Glasablage

**51504.29.79**

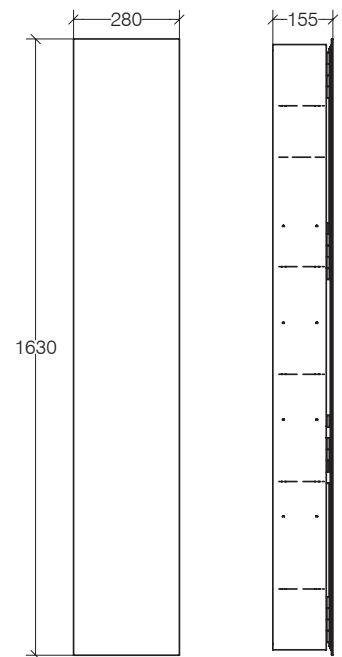

**Acciaio inox lucido**  
*Polished stainless steel*  
*Acier inox brillant*  
*Glänzender Edelstahl*



**.29.79**

**€ 496,00 - L**

## Pikà

### Colonna girevole con specchio e ripiani in vetro

Swivel cabinet with mirror and glass shelves

Colonne pivotante avec miroir et étagère en verre

Drehbarer Schrank mit Spiegel und Glasablage

51505.29

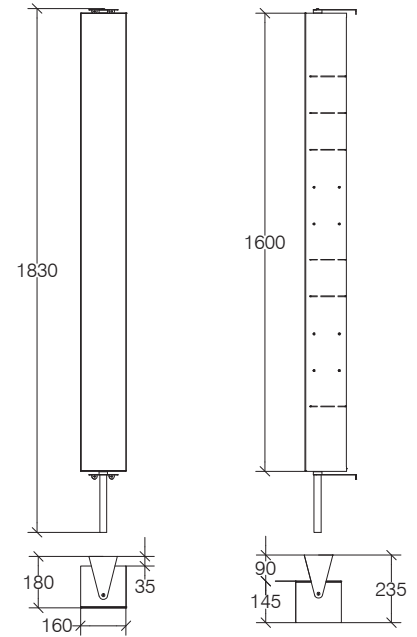

**Acciaio inox lucido**  
Polished stainless steel  
Acier inox brillant  
Glänzer Edelstahl



.29

€ 347,00 - M





**Colonna girevole con specchio e ripiani in vetro**

Swivel cabinet with mirror and glass shelves  
 Colonne pivotante avec miroir et étagère en verre  
 Drehbarer Schrank mit Spiegel und Glasablage

**51506.29**

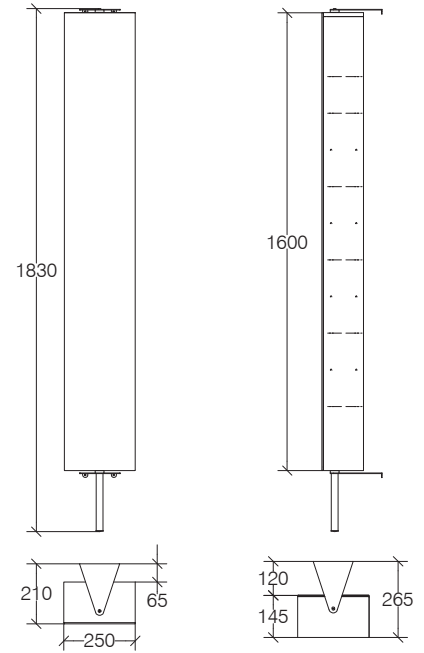

**Acciaio inox lucido**  
 Polished stainless steel  
 Acier inox brillant  
 Glänzer Edelstahl



**.29**

€ 370,00 - M

## Grela

**Colonna con anta destra con apertura push-pull e ripiani in vetro****8290DX.nn**

Cabinet with right door with push-pull and glass shelves /  
Colonne avec porte droite push-pull et étagère en verre  
Schrank mit rechte Tür push-pull und Glasablage

**Colonna con anta sinistra con apertura push-pull e ripiani in vetro****8290SX.nn**

Cabinet with left door with push-pull and glass shelves /  
Colonne avec porte gauche push-pull et étagère en verre  
Schrank mit linke Tür push-pull und Glasablage

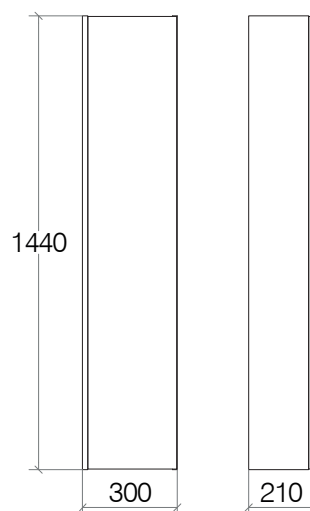
**Colonna da completare con profilo 82901 obbligatorio**

Cabinet must be completed with 82901 profile  
Colonne à compléter avec la baguette 82901  
Schrank muss mit dem Profil 82901 vervollständigt werden.

COD.	Descrizione / Description / Description / Beschrieb	L €	O €	N €
<b>8290DX.nn</b>	<b>Colonna con anta destra</b> Cabinet with right door / Colonne avec porte droite Schrank mit rechte Tür	485,00 - L	434,00 - L	330,00 - L
<b>8290SX.nn</b>	<b>Colonna con anta sinistra</b> Cabinet with left door / Colonne avec porte gauche Schrank mit linke Tür	485,00 - L	434,00 - L	330,00 - L

**Profilo per colonna H. 1440 mm**

Cabinet profile 1440 mm / Baguette pour colonne 1440 mm / Drehbarer profil 1440 mm

**82901.nn**

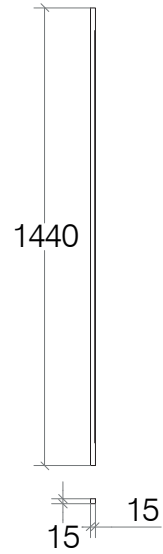

**Acciaio verniciato**  
Painted steel  
Acier laqué  
Lackiertem Stahl



**.09**

**.18**

€ 60,00

**Acciaio inox lucido**  
Polished stainless steel  
Acier inoxydable brillant  
Poliert Edelstahl



**.29**

€ 87,00

**Acciaio inox nickel nero**  
Black nickel stainless steel  
Acier inoxydable nickel  
Edelstahl Nickel Schwarz



**.33**

€ 151,00



<b>L</b>	<b>Laccato lucido</b> Glossy lacquered Laqué brillant Glänzend Lackiert				
		<b>.09L</b>	<b>.17L</b>	<b>.21L</b>	<b>.22L</b>

<b>O</b>	<b>Laccato opaco</b> Mat lacquered Laqué mat Matt Lackiert				
		<b>.09</b>	<b>.17</b>	<b>.21</b>	<b>.22</b>

<b>N</b>	<b>Laminato</b> Laminated Stratifié Holzlaminat				
		<b>.03</b>	<b>.01</b>	<b>.02</b>	<b>.05</b>

## Pikà

### Colonna girevole con specchio e ripiani in vetro

Swivel cabinet with mirror and glass shelves

Colonne pivotante avec miroir et étagère en verre

Drehbarer Schrank mit Spiegel und Glasablage

**8293.nn**

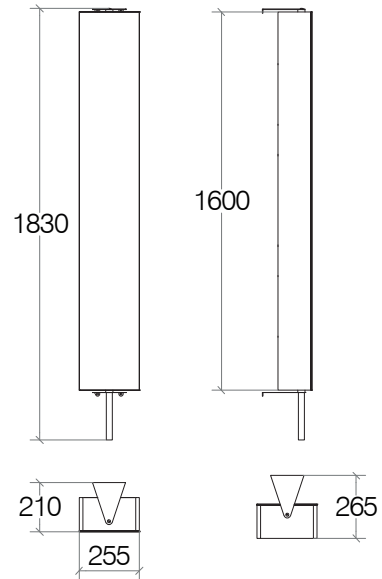









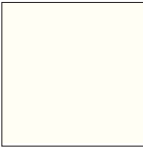

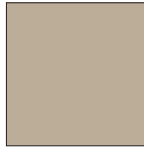

#### La staffa è sempre in ottone cromato

The bracket is always in chromed brass

Le support est toujours en laiton chromé

Die Halterung ist immer aus verchromtem Messing

<b>L</b>	<b>Laccato lucido</b> <i>Glossy lacquered</i> <i>Laqué brillant</i> <i>Glänzend Lackiert</i>						
		.09L	.17L	.21L	.22L		
		<b>O</b>	<b>Laccato opaco</b> <i>Mat lacquered</i> <i>Laqué mat</i> <i>Matt Lackiert</i>				
				.09	.17	.21	.22
<b>N</b>	<b>Laminato</b> <i>Laminated</i> <i>Stratifié</i> <i>Holzlaminat</i>						
		.03	.01	.02	.05		



COD.	Descrizione / Description / Description / Beschrieb	L €	O €	N €
<b>8293.nn</b>	<b>Colonna girevole con specchio e ripiani in vetro</b> Swivel cabinet with mirror and glass shelves Colonne pivotante avec miroir et étagère en verre Drehbarer Schrank mit Spiegel und Glasablage	470,00 - L	447,00 - L	415,00 - L

**Grela**

**Pensile con anta destra con apertura push-pull e ripiani in vetro**

**8291DX.nn**

Cabinet with right door push-pull and glass shelves  
 Armoire avec porte droite push-pull et étagère en verre  
 Schrank mit rechte Tür push-pull und Glasablage

**Pensile con anta sinistra con apertura push-pull e ripiani in vetro**

**8291SX.nn**



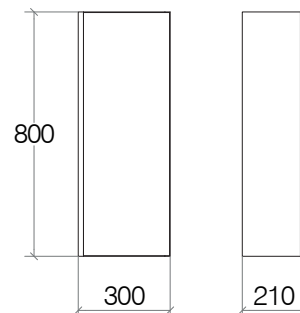



Cabinet with left door push-pull and glass shelves  
 Armoire avec porte gauche push-pull et étagère en verre  
 Schrank mit linke Tür push-pull und Glasablage

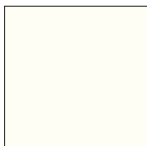
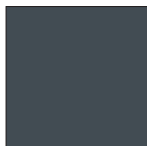
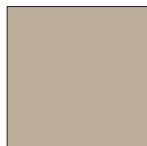

**Pensile da completare con profilo 82911 obbligatorio**

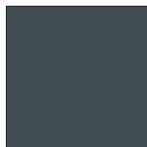
Cabinet must be completed with 82911 profile  
 Armoire à compléter avec la baguette 82911  
 Schrank muss mit dem Profil 82911 vervollständigt werden.

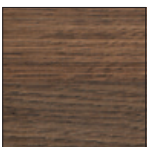
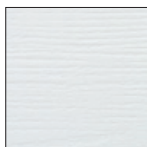
COD.	Descrizione / Description / Description / Beschrieb	L €	O €	N €
<b>8291DX.nn</b>	<b>Pensile con anta destra</b> Cabinet with right door / Armoire avec porte droite Schrank mit rechte Tür	382,00 - L	333,00 - L	271,00 - L
<b>8291SX.nn</b>	<b>Pensile con anta sinistra</b> Cabinet with left door / Armoire avec porte gauche Schrank mit linke Tür	382,00 - L	333,00 - L	271,00 - L

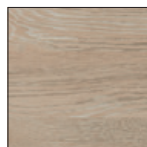
<b>L</b>	<b>Laccato lucido</b> Glossy lacquered Laqué brillant Glänzend Lackiert						
		.09L	.17L	.21L	.22L		
		<b>O</b>	<b>Laccato opaco</b> Mat lacquered Laqué mat Matt Lackiert				
				.09	.17	.21	.22
<b>N</b>	<b>Laminato</b> Laminated Stratifié Holzlaminiert						
				.03	.01	.02	.05

**Profilo per pensile H. 800 mm**

Cabinet profile 800 mm / Baguette pour armoire 800 mm / Schrank profil

**82911.nn**

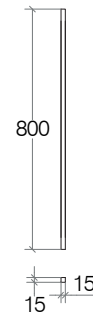

**Acciaio verniciato**  
Painted steel  
Acier laqué  
Lackiertem Stahl



.09 .18

€ 47,00

**Acciaio inox lucido**  
Polished stainless steel  
Acier inoxydable brillant  
Poliert Edelstahl



.29

€ 70,00

**Acciaio inox nickel nero**  
Black nickel stainless steel  
Acier inoxydable nickel noir  
Edelstahl Nickel Schwarz



.33

€ 104,00



**Specchio contenitore reversibile con ripiani in vetro**

Reversible container mirror with glass shelves

Armoire de toilette reversible avec miroir et étagère en verre

Spiegelbehälter mit Glasablage Wechselseitige Montage, mit Glasablage

**81141.03**

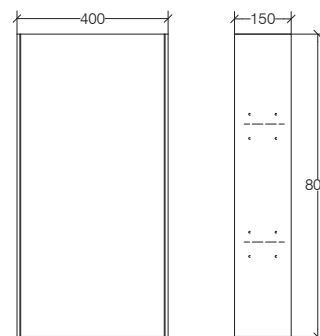

**Bambù verniciato**  
Vernished Bamboo  
Bambou laqué  
Zinnobambus



.03

€ 347,00 - M

## Ciacole - Pikà

### Pensile con anta a specchio

Cabinet with mirror door / Armoire avec porte miroir / Schrank mit Spiegeltür

8051.nn

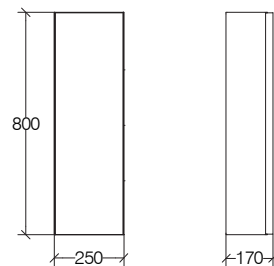

Alluminio verniciato  
Painted aluminium  
Aluminium laqué  
Lackiertem Aluminium



.09

.17

.18

€ 400,00 - M



### Pensile con anta a specchio e ripiani in vetro

Cabinet with mirror door and glass shelves  
Armoire avec porte miroir et étagère en verre  
Schrank mit Spiegeltür und Glasablage

51502.29.79

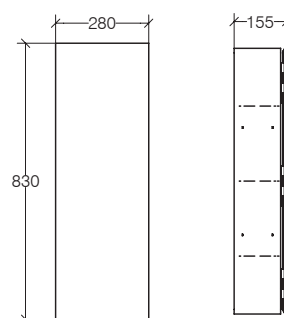

Acciaio inox lucido  
Polished stainless steel  
Acier inox brillant  
Glänzender Edelstahl



.29.79

€ 370,00 - M





**Pensile con anta a specchio e ripiani in vetro**

Cabinet with mirror door and glass shelves  
Armoire avec porte miroir et étagère en verre  
Schrank mit Spiegeltür und Glasablage

**51511.29**

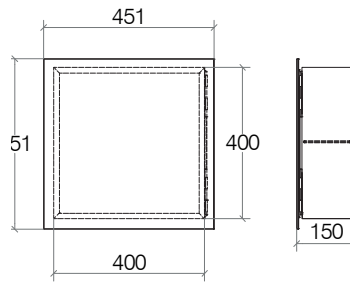

**Acciaio inox lucido**  
Polished stainless steel  
Acier inox brillant  
Glänzer Edelstahl



.29

€ 271,00 - S



**Pensile con anta a specchio e ripiani in vetro**

Cabinet with mirror door and glass shelves  
Armoire avec porte miroir et étagère en verre  
Schrank mit Spiegeltür und Glasablage

**51512.29**

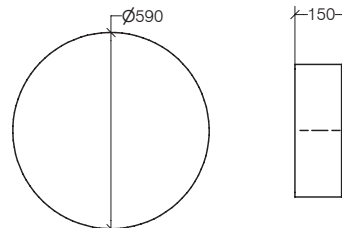
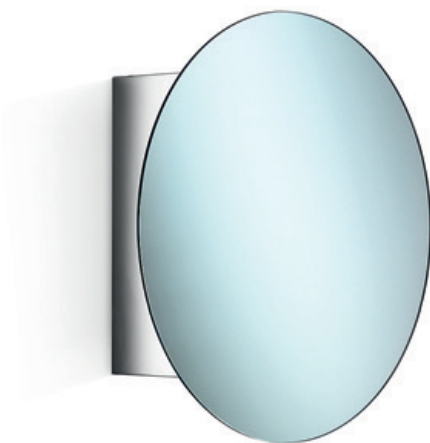

**Acciaio inox lucido**  
Polished stainless steel  
Acier inox brillant  
Glänzer Edelstahl



.29.79

€ 303,00 - M



# basi su ruote

*Drawer units on castors / Meubles sur roulettes / Schränke auf Rollen*



## Runner

### Base 5 cassetti, con ruote

5 drawers unit on wheels / Meuble sur roulettes avec 5 tiroirs / Rollcontainer 5 Schubladen

5430.nn

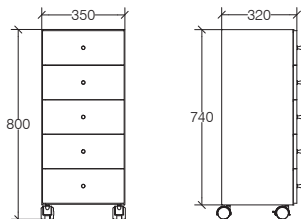

**Acciaio inox lucido**  
Polished stainless steel  
Acier inox brillant  
Glänzer Edelstahl



.29.29

€ 419,00 - M

**Acciaio verniciato**  
Painted stainless steel  
Acier inox laqué  
Lackiertem Edelstahl



.09

.17

.18

€ 430,00 - M

### Copribase in mattstone

Mattstone top / Tablette en mattstone / Mattstoneplatte

5442.26

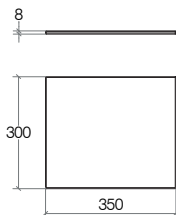
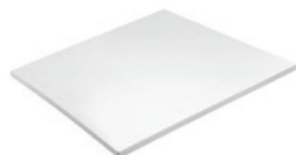

**Mattstone**  
Mattstone  
Mattstone  
Mattstone



.26

€ 62,00

### Base 2 cassetti, 1 anta, con ruote

1 door, 2 drawers unit on wheels / Meuble sur roulettes avec 2 tiroirs et 1 porte / Rollcontainer 2 Schublade 1 Tür

5431.nn

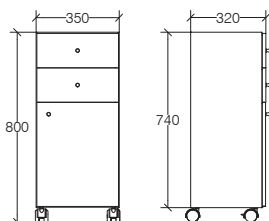

**Acciaio inox lucido**  
Polished stainless steel  
Acier inox brillant  
Glänzer Edelstahl



.29.29

€ 342,00 - M

**Acciaio verniciato**  
Painted stainless steel  
Acier inox laqué  
Lackiertem Edelstahl



.09

.17

.18

€ 364,00 - M

### Copribase in mattstone

Mattstone top / Tablette en mattstone / Mattstoneplatte

5442.26

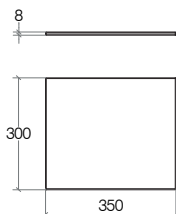
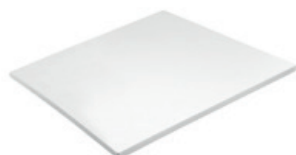

**Mattstone**  
Mattstone  
Mattstone  
Mattstone



.26

€ 62,00

**Runner**

**Base 1 cassetto, 1 anta, con ruote**

**5435.29.29**

1 door with 1 drawer on wheels / Meuble sur roulettes avec 1 tiroir et 1 porte / Rollcontainer 1 Schublade und 1 Tür

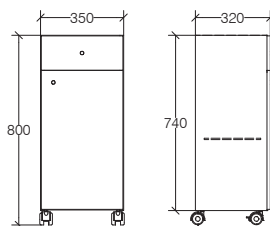

**Acciaio inox lucido**  
Polished stainless steel  
Acier inox brillant  
Glänzer Edelstahl



**.29.29**

€ 326,00 - M

**Copribase in mattstone**

**5442.26**

Mattstone top / Tablette en mattstone / Mattstoneplatte

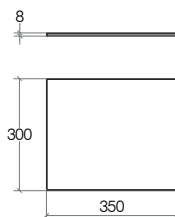

**Mattstone**  
Mattstone  
Mattstone  
Mattstone



**.26**

€ 62,00



**Base 3 cassetti, con ruote**

**5436.nn**

3 drawers unit, on wheels / Meuble sur roulettes avec 3 tiroirs / Rollcontainer 3 Schubladen

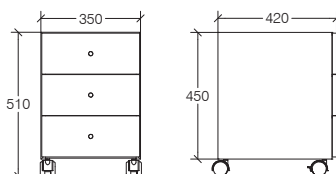

**Acciaio inox lucido**  
Polished stainless steel  
Acier inox brillant  
Glänzer Edelstahl



**.29.29**

€ 342,00 - M

**Acciaio verniciato**  
Painted stainless steel  
Acier inox laqué  
Lackiertem Edelstahl



**.09**

**.17**

**.18**

€ 353,00 - M

**Copribase in mattstone**

**5443.26**

Mattstone top / Tablette en mattstone / Mattstoneplatte

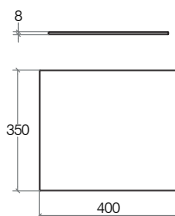
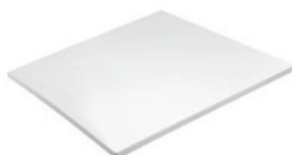

**Mattstone**  
Mattstone  
Mattstone  
Mattstone



**.26**

€ 73,00

## Runner

### Base 2 cassetti, con ruote

5438.nn

2 drawers unit, on wheels / Meuble sur roulettes avec 2 tiroirs / Rollcontainer 2 Schubladen

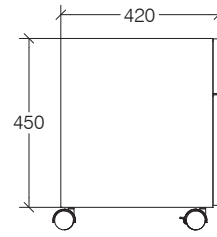
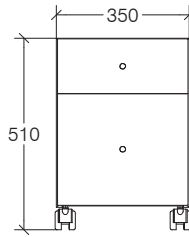

**Acciaio inox lucido**  
Polished stainless steel  
Acier inox brillant  
Glänzer Edelstahl



.29

€ 309,00 - M

**Acciaio verniciato**  
Painted stainless steel  
Acier inox laqué  
Lackiertem Edelstahl



.09



.17



.18

€ 320,00 - M

### Copribase in mattstone

Mattstone top / Tablette en mattstone / Mattstoneplatte

5443.26

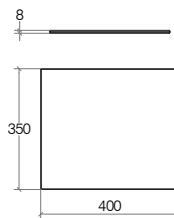

**Mattstone**  
Mattstone  
Mattstone  
Mattstone



.26

€ 73,00



**NEW**

Basi su ruote / Drawer units on castors / Meubles sur roulettes / Schränke auf Rollen

**Careto**

**Carrellino su ruote con tre ripiani**

Cart on wheels with three shelves / Desserte sur roulettes avec trois étagères / Rollschrank mit drei Regalen

**5450.nn**

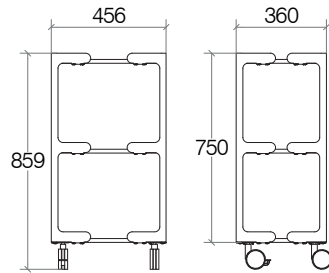

**Alluminio verniciato**  
Painted aluminium  
Aluminium laqué  
Lackiertem Aluminium

**Bambù verniciato**  
Vernished Bamboo  
Bambou laqué  
Zinnobambus



**.09**



**.17**



**.18**

€ 495,00 - L



## Ricambi / Spare parts / Pièces détachées / Ersatzteile

<b>51502</b>	R26515021	Anta completa per art.51502 - Complete door for art. 51502	<b>61,00</b>
	R26515062	Ripiano vetro temperato 215x124 mm - Tempered glass shelf 215x124 mm	<b>7,00</b>
	R2251603	Confezione 4 reggi piano - 4 pins shelf holder set	<b>3,00</b>
	R51502	Kit porta calamita - Magnet holder kit	<b>5,00</b>
	R2250009	Set 4 viti + 4 tasselli+ 2 ganci specchio revers. - Set 4 screws + 4 plugs + 2 830 hooks for rev.mirror	<b>4,00</b>
<b>51504</b>	R26515041	Anta completa per art.51504 - Complete door for art. 51504	<b>106,00</b>
	R26515062	Ripiano vetro temperato 215x124 mm - Tempered glass shelf 215x124 mm	<b>7,00</b>
	R2251603	Confezione 4 reggi piano - 4 pins shelf holder set	<b>3,00</b>
	R51502	Kit porta calamita - Magnet holder kit	<b>5,00</b>
	R2250009	Set 4 viti + 4 tasselli+ 2 ganci specchio revers. - Set 4 screws + 4 plugs + 2 830 hooks for rev.mirror	<b>4,00</b>
<b>51505</b>	R26515052	Ripiano vetro temperato 124x124 mm - Tempered glass shelf 124x124 mm	<b>5,00</b>
	R2251603	Confezione 4 reggi piano - 4 pins shelf holder set	<b>3,00</b>
	R25515054	Kit ricambio staffe e gamba - Spare kit for leg and staff	<b>34,00</b>
<b>51506</b>	R26515062	Ripiano vetro temperato 215x124 mm - Tempered glass shelf 215x124 mm	<b>7,00</b>
	R2251603	Confezione 4 reggi piano - 4 pins shelf holder set	<b>3,00</b>
	R25515064	Kit ricambio staffe e gamba - Spare kit for leg and st	<b>83,00</b>
<b>51511</b>	R26515112	Ripiano vetro temperato 365x124 mm - Tempered glass shelf 365x124 mm	<b>10,00</b>
	R51502	Kit porta calamita - Magnet holder kit	<b>5,00</b>
	R2250009	Set 4 viti + 4 tasselli + 2 ganci specchio reversibile - Set 4 screws + 4 plugs + 2 hooks for rev.mirror	<b>4,00</b>
<b>51512</b>	R26515112	Ripiano vetro temperato 365x124 mm - Tempered glass shelf 365x124 mm	<b>10,00</b>
	R51502	Kit porta calamita - Magnet holder kit	<b>5,00</b>
	R2250009	Set 4 viti + 4 tasselli + 2 ganci specchio reversibile - Set 4 screws + 4 plugs + 2 hooks for rev.mirror	<b>4,00</b>
<b>5430</b>	R2500402B	Kit pomolo tondo per anta e cassetto cromo - Round knob for door and drawer chromed	<b>4,00</b>
	R2254305	Ruota con freno - Wheel with brake	<b>5,00</b>
	R2254306	Ruota - Wheel	<b>5,00</b>
	R2254308	Confezione 2 viti + 1 borchia per Runner 2 screws + 1 stud for Runner	<b>4,00</b>
	R2354301	Cassetto - Drawer	<b>27,00</b>
	R240040309	Kit pomolo quadrato per anta e cassetto bianco - Square knob for door and drawer white	<b>10,00</b>
	R240040317	Kit pomolo quadrato per anta e cassetto grigio - Square knob for door and drawer grey	<b>10,00</b>
	R240040318	Kit pomolo quadrato per anta e cassetto nero - Square knob for door and drawer black	<b>10,00</b>
<b>8293</b>	R2282931	kit 4 reggipiano trasparente per colonna girevole 4 transparent pins shelf holder set for swivel cabinet	<b>7,00</b>
	R26515062	Ripiano vetro temperato - Tempered glass shelf	<b>7,00</b>
<b>8290DX</b>	R2282901	kit 4 reggipiano con piolino per pensili con anta 4 pins shelf holder set with peg for cabinet with door	<b>10,00</b>
	R2682901	Ripiano in vetro per pensili con anta - Tempered glass shelf for cabinet with door	<b>11,00</b>
<b>8290SX</b>	R2282901	kit 4 reggipiano con piolino per pensili con anta 4 pins shelf holder set with peg for cabinet with door	<b>10,00</b>
	R2682901	Ripiano in vetro per pensili con anta - Tempered glass shelf for cabinet with door	<b>11,00</b>



## Ricambi / Spare parts / Pièces détachées / Ersatzteile

<b>8291DX</b>	R2282901	kit 4 reggipiano con piolino per pensili con anta 4 pins shelf holder set with peg for cabinet with door	<b>10,00</b>
	R2682901	Ripiano in vetro per pensili con anta - Tempered glass shelf for cabinet with door	<b>11,00</b>
<b>8291SX</b>	R2282901	kit 4 reggipiano con piolino per pensili con anta 4 pins shelf holder set with peg for cabinet with door	<b>10,00</b>
	R2682901	Ripiano in vetro per pensili con anta - Tempered glass shelf for cabinet with door	<b>11,00</b>
<b>5431</b>	R2500402B	Kit pomolo tondo per anta e cassetto cromo - Round knob for door and drawer chromed	<b>4,00</b>
	R2254305	Ruota con freno - Wheel with brake	<b>5,00</b>
	R2254306	Ruota - Wheel	<b>5,00</b>
	R2654342	Vetro ripiano - Glass shelf	<b>15,00</b>
	R2251603	Confezione 4 reggi piano - 4 pins shelf holder set	<b>3,00</b>
	R2354301	Cassetto - Drawer	<b>27,00</b>
	R2254308	Confezione 2 viti + 1 borchia per Runner 2 screws + 1 stud for Runner	<b>4,00</b>
	R240040309	Kit pomolo quadrato per anta e cassetto bianco - Square knob for door and drawer white	<b>10,00</b>
	R240040317	Kit pomolo quadrato per anta e cassetto grigio - Square knob for door and drawer grey	<b>10,00</b>
	R240040318	Kit pomolo quadrato per anta e cassetto nero - Square knob for door and drawer black	<b>10,00</b>
<b>5435</b>	R2500402B	Kit pomolo tondo per anta e cassetto cromo - Round knob for door and drawer chromed	<b>4,00</b>
	R2254305	Ruota con freno - Wheel with brake	<b>5,00</b>
	R2254306	Ruota - Wheel	<b>5,00</b>
	R2654342	Vetro ripiano - Glass shelf	<b>15,00</b>
	R2251603	Confezione 4 reggi piano - 4 pins shelf holder set	<b>3,00</b>
	R2254308	Confezione 2 viti + 1 borchia per Runner 2 screws + 1 stud for Runner	<b>4,00</b>
	R2354301	Cassetto - Drawer	<b>27,00</b>
<b>5436</b>	R2500402B	Kit pomolo tondo per anta e cassetto cromo - Round knob for door and drawer chromed	<b>4,00</b>
	R2254305	Ruota con freno - Wheel with brake	<b>5,00</b>
	R2254306	Ruota - Wheel	<b>5,00</b>
	R2254308	Confezione 2 viti + 1 borchia per Runner 2 screws + 1 stud for Runner	<b>4,00</b>
	R2354361	Cassetto piccolo - Small drawer	<b>27,00</b>
	R240040309	Kit pomolo quadrato per anta e cassetto bianco - Square knob for door and drawer white	<b>10,00</b>
	R240040317	Kit pomolo quadrato per anta e cassetto grigio - Square knob for door and drawer grey	<b>10,00</b>
	R240040318	Kit pomolo quadrato per anta e cassetto nero - Square knob for door and drawer black	<b>10,00</b>



# lavabi

*washbasins / vasques / Waschbecken*

## **Lavabi da appoggio / 250**

*Countertop washbasins / Vasques à poser / Aufsatzbecken*

## **Lavabi a muro / 262**

*wall-mounted washbasins / Lavabos suspendus / Wandwaschbecken*

## **Free standing / 268**

*Pedestal washbasins / Lavabos colonne / Pedestal Waschbecken*

## **Lavabi ad incasso / 272**

*built-in washbasins / Lavabos encastrés / Einbauwaschbecken*







## Lavabi da appoggio

Countertop washbasins / Vasques à poser / Aufsatzwaschbecken

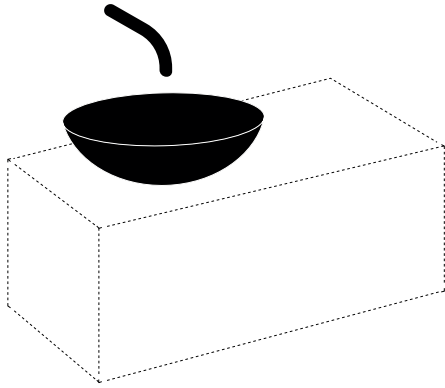

## Galateo / Momon

### Galateo

53725.09

#### Lavabo in ceramica con troppopieno, completo di rubinetto, miscelatore, piletta e griglia portasapone

Ceramic washbasin with overflow, complete with faucet, mixer, click clack waste water drain and soap holder grid.

Vasque en céramique avec trop-plein, robinetterie, bonde et grille pour savon

Keramikbecken montage mit Überlauf, Armatur, Ablaufgarnitur und Einlage für Seifenschale

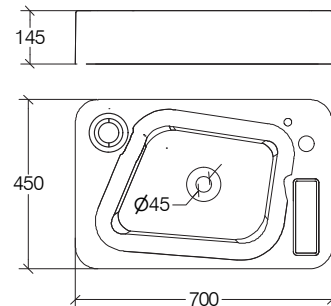

**Ceramica lucida**  
Polished ceramic  
Céramique brillante  
Keramik poliert



.09

€ 606,00 - M



### Lavabo da appoggio con piletta a scarico libero

Countertop washbasin, with free waste water drain

Vasque à poser, avec bonde à écoulement libre

Aufsatzbecken mit freie Ablaufgarnitur

53553.26

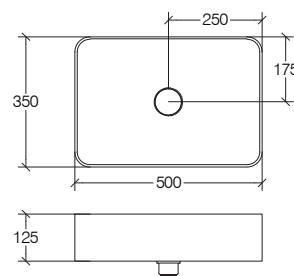

**Mattstone**  
Mattstone  
Mattstone  
Mattstone



.26

€ 364,00 - M



**Lavabo da appoggio con piletta a scarico libero**

Countertop washbasin with freeflow wastewater drain  
 Vasque à poser avec bonde à écoulement libre  
 Aufsatzbecken mit freie Ablaufgarnitur

**53563.26**

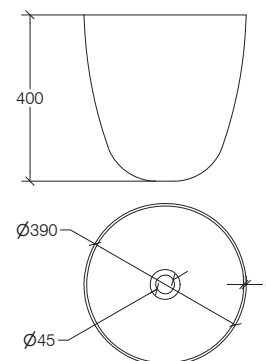

Mattstone  
 Mattstone  
 Mattstone  
 Mattstone



.26



€ 496,00 - M



**Lavabo da appoggio con piletta a scarico libero**

Countertop washbasin with freeflow wastewater drain  
 Vasque à poser avec bonde à écoulement libre  
 Aufsatzbecken mit freie Ablaufgarnitur

**53564.26**

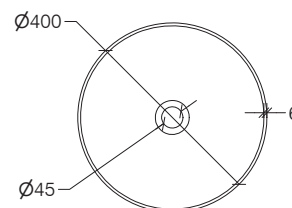

Mattstone  
 Mattstone  
 Mattstone  
 Mattstone



.26



€ 419,00 - M

## Acquaio

### Vasca ovale da appoggio senza piletta

Oval countertop washbasin without free waste water drain  
 Vasque ovale à poser sans bonde  
 Rundes Aufsatzbecken ohne Ablaufgarnitur

536982.nn

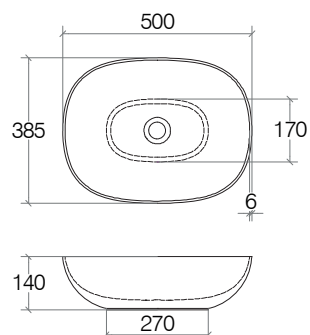

**Ceramica lucida**  
 Polished ceramic  
 Céramique brillante  
 Keramik poliert

**Ceramica opaca**  
 Matt ceramic  
 Céramique mate  
 Keramik matt



.09

.17

.26

€ 331,00 - M

€ 464,00 - M



### Vasca ovale da appoggio senza piletta

Oval countertop washbasin without free waste water drain  
 Vasque ovale à poser sans bonde  
 Rundes Aufsatzbecken ohne Ablaufgarnitur

536983.nn

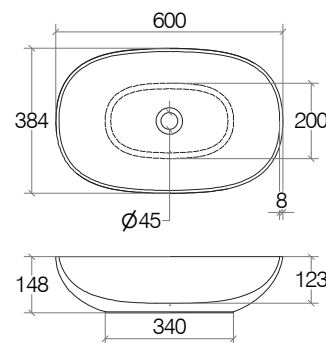

**Ceramica lucida**  
 Polished ceramic  
 Céramique brillante  
 Keramik poliert

**Ceramica opaca**  
 Matt ceramic  
 Céramique mate  
 Keramik matt



.09

.17

.26

€ 353,00 - M

€ 496,00 - M





**Vasca ovale da appoggio senza piletta**

Oval countertop washbasin without free waste water drain  
 Vasque ovale à poser sans bonde  
 Rundes Aufsatzbecken ohne Ablaufgarnitur

**536984.09**

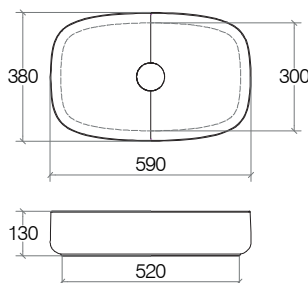

**Ceramica lucida**  
 Polished ceramic  
 Céramique brillante  
 Keramik poliert



**.09**  
 € 485,00 - M

**Vasca ovale da appoggio senza piletta**

Oval countertop washbasin without free waste water drain  
 Vasque ovale à poser sans bonde  
 Rundes Aufsatzbecken ohne Ablaufgarnitur

**536985.nn**

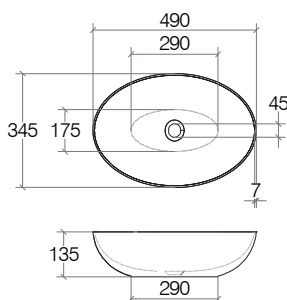

**Ceramica lucida**  
 Polished ceramic  
 Céramique brillante  
 Keramik poliert



**.09**  
 € 320,00 - M

**Ceramica opaca**  
 Matt ceramic  
 Céramique mate  
 Keramik matt



**.17**     **.26**  
 € 452,00 - M



**Vasca tonda da appoggio senza piletta**

Round countertop washbasin without free waste water drain  
 Vasque ronde à poser sans bonde  
 Ovale Aufsatzbecken ohne Ablaufgarnitur

**536986.09**

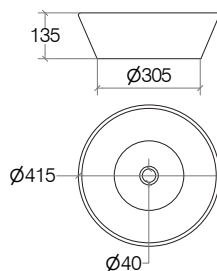

**Ceramica lucida**  
 Polished ceramic  
 Céramique brillante  
 Keramik poliert



**.09**  
 € 292,00 - M

## Quarelo

### Lavabo da appoggio, senza piletta

53703.nn

Countertop washbasin, without waste water drain  
 Vasque à poser, sans bonde  
 Becken ohne Ablaufgarnitur Wandmontage od. Aufzusetzen

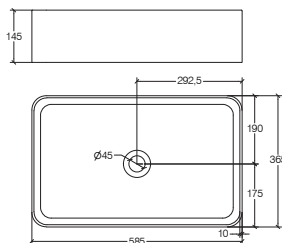

**Ceramica lucida**  
 Polished ceramic  
 Céramique brillante  
 Keramik poliert



.09

€ 452,00 - M

**Ceramica opaca**  
 Matt ceramic  
 Céramique mate  
 Keramik matt



.17

€ 496,00 - M



.26



### Lavabo da appoggio con foro rubinetto, senza piletta

53706.29.nn

Countertop washbasin with tap hole, without waste water drain  
 Vasque à poser avec perçage de robinetterie, sans bonde  
 Becken mit Armatur Loch, od. Aufzusetzen

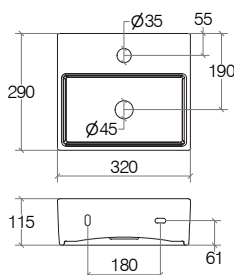

**Ceramica lucida**  
 Polished ceramic  
 Céramique brillante  
 Keramik poliert



.09

€ 216,00 - M

**Ceramica opaca**  
 Matt ceramic  
 Céramique mate  
 Keramik matt



.17

€ 276,00 - M



.26



### Lavabo da appoggio senza foro rubinetto, senza piletta

537061.29.09

Countertop washbasin without tap hole, without waste water drain  
 Vasque à poser sans perçage de robinetterie, sans bonde  
 Becken ohne Armatur Loch, od. Aufzusetzen

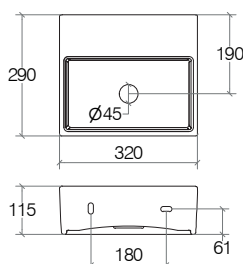

**Ceramica lucida**  
 Polished ceramic  
 Céramique brillante  
 Keramik poliert



.09

€ 216,00 - M



**Lavabo da appoggio con foro rubinetto, senza piletta**

**53708.nn**

Countertop washbasin with tap hole, without waste water drain  
 Vasque à poser avec perçage de robinetterie, sans bonde  
 Becken mit Armatur Loch, od. Aufzusetzen

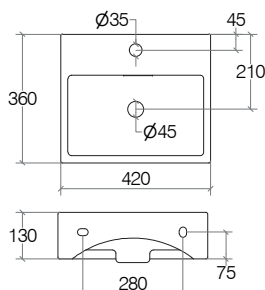

**Ceramica lucida**  
 Polished ceramic  
 Céramique brillante  
 Keramik poliert



.09

€ 298,00 - M

**Ceramica opaca**  
 Matt ceramic  
 Céramique mate  
 Keramik matt



.17



.26

€ 342,00 - M



**Lavabo da appoggio senza foro rubinetto, senza piletta**

**537081.09**

Countertop washbasin without tap hole, without waste water drain  
 Vasque à poser sans perçage de robinetterie, sans bonde  
 Becken ohne Armatur Loch, od. Aufzusetzen

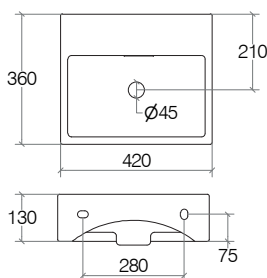

**Ceramica lucida**  
 Polished ceramic  
 Céramique brillante  
 Keramik poliert



.09

€ 298,00 - M



**Lavabo da appoggio con foro rubinetto, senza piletta**

**53709.nn**

Countertop washbasin with tap hole, without waste water drain  
 Vasque à poser avec perçage de robinetterie, sans bonde  
 Becken mit Armatur Loch, od. Aufzusetzen

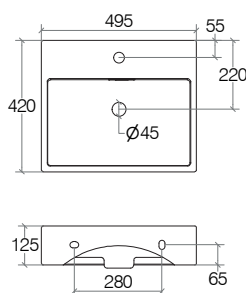

**Ceramica lucida**  
 Polished ceramic  
 Céramique brillante  
 Keramik poliert



.09

€ 353,00 - M

**Ceramica opaca**  
 Matt ceramic  
 Céramique mate  
 Keramik matt



.17



.26

€ 397,00 - M



## Quarelo

### Lavabo da appoggio senza foro rubinetto, senza piletta

537091.09

Countertop washbasin without tap hole, without waste water drain  
 Vasque à poser sans perçage de robinetterie, sans bonde  
 Becken ohne Armatur Loch, od. Aufzusetzen

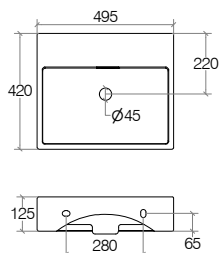

**Ceramica lucida**  
 Polished ceramic  
 Céramique brillante  
 Keramik poliert



.09

€ 353,00 - M



### Lavabo da appoggio con foro rubinetto, senza piletta

53710.nn

Countertop washbasin with tap hole, without waste water drain  
 Vasque à poser avec perçage de robinetterie, sans bonde  
 Becken mit Armatur Loch, od. Aufzusetzen

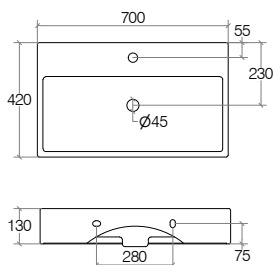

**Ceramica lucida**  
 Polished ceramic  
 Céramique brillante  
 Keramik poliert



.09

€ 441,00 - M

**Ceramica opaca**  
 Matt ceramic  
 Céramique mate  
 Keramik matt



.17

.26

€ 485,00 - M



### Lavabo da appoggio senza foro rubinetto, senza piletta

537101.09

Countertop washbasin without tap hole, without waste water drain  
 Vasque à poser sans perçage de robinetterie, sans bonde  
 Becken ohne Armatur Loch, od. Aufzusetzen

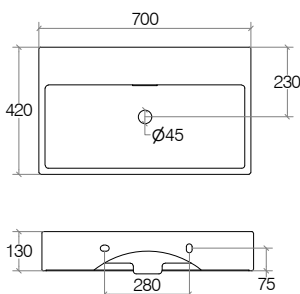

**Ceramica lucida**  
 Polished ceramic  
 Céramique brillante  
 Keramik poliert



.09

€ 441,00 - M



**Vasca tonda da appoggio senza piletta**

Round countertop washbasin without free waste water drain  
 Vasque ronde à poser sans bonde  
 Ovale Aufsatzbecken ohne Ablaufgarnitur

536981.nn

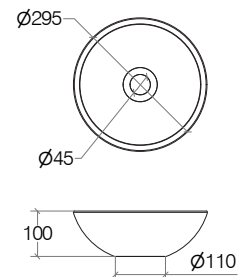

**Ceramica lucida**  
 Polished ceramic  
 Céramique brillante  
 Keramik poliert



.09

€ 193,00 - S

**Ceramica opaca**  
 Matt ceramic  
 Céramique mate  
 Keramik matt



.17

.26

€ 260,00 - M



**Vasca tonda da appoggio senza piletta**

Round countertop washbasin without free waste water drain  
 Vasque ronde à poser sans bonde  
 Ovale Aufsatzbecken ohne Ablaufgarnitur

536991.nn

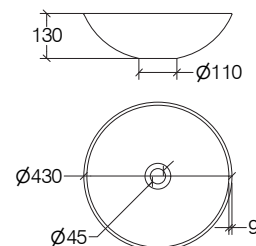

**Ceramica lucida**  
 Polished ceramic  
 Céramique brillante  
 Keramik poliert



.09

€ 276,00 - S

**Ceramica opaca**  
 Matt ceramic  
 Céramique mate  
 Keramik matt



.17

.26

€ 359,00 - M



## Acquaio

### Vasca tonda da appoggio senza piletta

Round countertop washbasin without free waste water drain  
Vasque ronde à poser sans bonde  
Ovales Aufsatzbecken ohne Ablaufgarnitur

53586.29

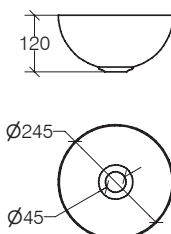

**Acciaio inox lucido**  
Polished stainless steel  
Acier inoxydable brillant  
Poliertes Edelstahl



€ 126,00 - S

### Vasca tonda da appoggio senza piletta

Round countertop washbasin without free waste water drain  
Vasque ronde à poser sans bonde  
Ovales Aufsatzbecken ohne Ablaufgarnitur

53596.29

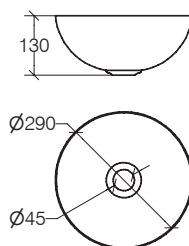

**Acciaio inox lucido**  
Polished stainless steel  
Acier inoxydable brillant  
Poliertes Edelstahl



€ 144,00 - S

### Vasca tonda da appoggio senza piletta

Round countertop washbasin without free waste water drain  
Vasque ronde à poser sans bonde  
Ovales Aufsatzbecken ohne Ablaufgarnitur

53666.29

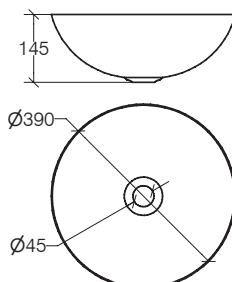

**Acciaio inox lucido**  
Polished stainless steel  
Acier inoxydable brillant  
Poliertes Edelstahl



€ 265,00 - S

**Vasca tonda da appoggio senza piletta**

**53694.03**

Round countertop washbasin without free waste water drain  
 Vasque ronde à poser sans bonde  
 Ouales Aufsatzbecken ohne Ablaufgarnitur

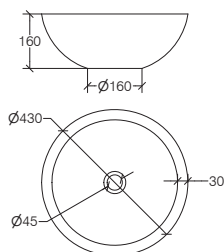

**Bambù naturale**  
 Natural bamboo  
 Bambou naturel  
 Natürlicher bambus



€ 298,00 - S

**Vasca tonda da appoggio senza piletta**

**53695.29.nn**

Round countertop washbasin without free waste water drain  
 Vasque ronde à poser sans bonde  
 Ouales Aufsatzbecken ohne Ablaufgarnitur

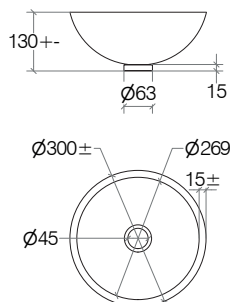

**Vetro**  
 Glass  
 Verre  
 Glas



.29

.30

.82

.84

€ 287,00 - S

€ 253,00 - S



**Vasca tonda da appoggio senza piletta**

**53696.29.nn**

Round countertop washbasin without free waste water drain  
 Vasque ronde à poser sans bonde  
 Ouales Aufsatzbecken ohne Ablaufgarnitur

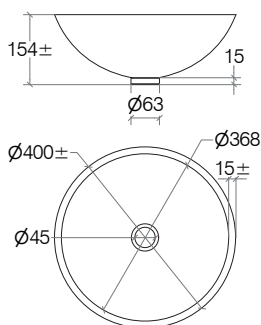

**Vetro**  
 Glass  
 Verre  
 Glas



.29

.30

.82

.84

€ 331,00 - S

€ 276,00 - S



SAPONE  
HANDI

SAPONE  
HANDI  
GREEN  
lineabeta

lineabeta



## Lavabi a muro

Wall-mounted washbasins / Lavabos suspendus / Wandwaschbecken

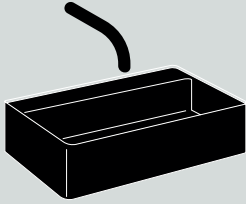

## Ciuci\_Pocia\_Quarelo

### Ciuci

#### Lavabo con supporto, piletta scarico libero Art. 53971, sifone Art. 53922

Washbasin with wall bearing, free waste water drain Art. 53971, siphon Art. 53922

Lavabo avec support, bonde à écoulement libre 53971, siphon 53922

Becken mit Halterung, freie Ablaufgarnitur 53971, Siphon 53922

**6622.nn +**  
art. 5371,  
art 53922

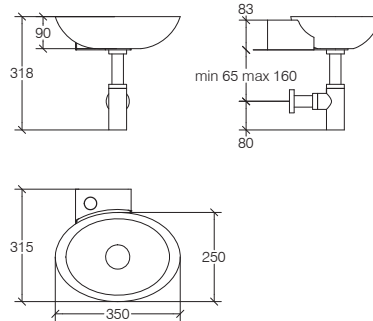

**Mattstone**  
Mattstone  
Mattstone  
Mattstone



€ 370,00 - M

### Pocia

#### Lavabo con supporto, piletta scarico libero Art. 53971, sifone Art. 53922

Washbasin with wall bearing, free waste water drain Art. 53971, siphon Art. 53922

Lavabo avec bonde à écoulement libre 53971, siphon 53922

Becken mit Ablaufgarnitur 53971 und Siphon 53922

**665801.29.83 +**  
art. 53971,  
art 53922

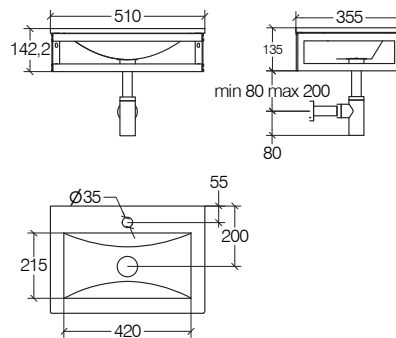

**Vetro**  
Glass  
Verre  
Glasse



€ 656,00 - M

### Quarelo

#### Lavabo a muro, senza troppopieno e piletta

Washbasin, without overflow and waste water drain

Lavabo mural, sans trop-plein et bonde

Becken, ohne Überlauff, od. Aufzusetzen

**53706.nn**

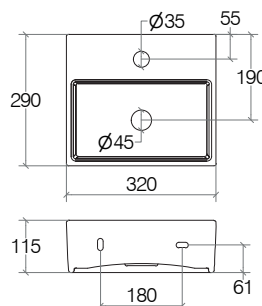

**Ceramica lucida**  
Polished ceramic  
Céramique brillante  
Keramik poliert



.09

€ 216,00 - M

**Ceramica opaca**  
Matt ceramic  
Céramique mate  
Keramik matt



.17



.26

€ 276,00 - M

**Lavabo a muro senza foro rubinetto, senza troppopieno e piletta**

**537061.29.09**

Wall washbasin without tap hole, without overflow and waste water drain  
 Lavabo mural sans perçage de robinetterie, sans trop-plein et bonde  
 Keramikbecken ohne Loch für Armatur, ohne Überlauf, od. Aufzusetzen

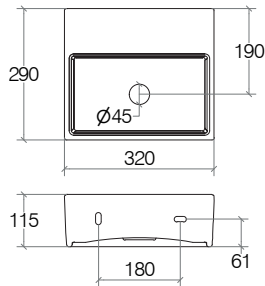

**Ceramica lucida**  
 Polished ceramic  
 Céramique brillante  
 Keramik poliert



.09

€ 216,00 - S



**Lavabo a muro con foro rubinetto, senza piletta**

**53708.nn**

Wall washbasin with tap hole, without waste water drain  
 Lavabo à accrocher au mur avec perçage de robinetterie, sans bonde  
 Becken mit Armatur Loch, od. Aufzusetzen

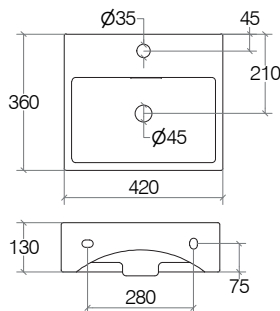

**Ceramica lucida**  
 Polished ceramic  
 Céramique brillante  
 Keramik poliert



.09

€ 298,00 - S

**Ceramica opaca**  
 Matt ceramic  
 Céramique mate  
 Keramik matt



.17



.26

€ 342,00 - M



**Lavabo a muro senza foro rubinetto, senza piletta**

**537081.09**

Wall washbasin without tap hole, without waste water drain  
 Lavabo à accrocher au mur sans perçage de robinetterie, sans bonde  
 Keramikbecken ohne Loch für Armatur, od. Aufzusetzen

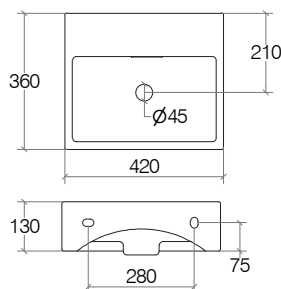

**Ceramica lucida**  
 Polished ceramic  
 Céramique brillante  
 Keramik poliert



.09

€ 298,00 - S



## Quarelo

### Lavabo a muro, senza piletta

Wall washbasin, without waste water drain

Lavabo à accrocher au mur, sans bonde

Becken ohne Ablaufgarnitur Wandmontage od. Aufzusetzen

53709.nn

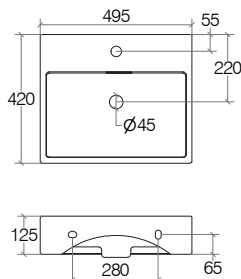

**Ceramica lucida**  
Polished ceramic  
Céramique brillante  
Keramik poliert



.09

€ 353,00 - M

**Ceramica opaca**  
Matt ceramic  
Céramique mate  
Keramik matt



.17

€ 397,00 - M



.26



### Lavabo a muro senza foro rubinetto, senza piletta

Wall washbasin without tap hole, without waste water drain

Lavabo à accrocher au mur sans perçage de robinetterie, sans bonde

Becken ohne Ablaufgarnitur Wandmontage od ohne loch für armatur. Aufzusetzen

537091.09

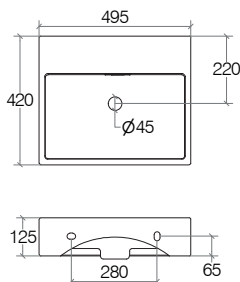

**Ceramica lucida**  
Polished ceramic  
Céramique brillante  
Keramik poliert



.09

€ 353,00 - M



### Lavabo a muro, senza piletta

Wall washbasin, without waste water drain

Lavabo à accrocher au mur, sans bonde

Becken ohne Ablaufgarnitur Wandmontage od. Aufzusetzen

53710.nn

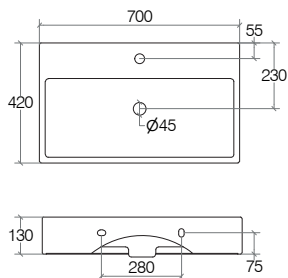

**Ceramica lucida**  
Polished ceramic  
Céramique brillante  
Keramik poliert



.09

€ 441,00 - M

**Ceramica opaca**  
Matt ceramic  
Céramique mate  
Keramik matt



.17

€ 485,00 - M



.26



**Lavabo a muro senza foro rubinetto, senza piletta**

**537101.09**

Wall countertop washbasin without tap hole, without waste water drain

Lavabo à accrocher au mur sans perçage de robinetterie, sans bonde

Becken ohne Ablaufgarnitur Wandmontage od ohne loch für armatur. Aufzusetzen

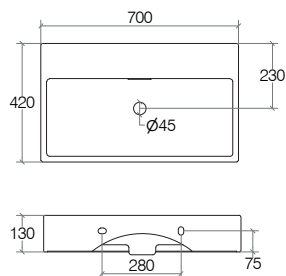

**Ceramica lucida**  
Polished ceramic  
Céramique brillante  
Keramik poliert



.09

€ 441,00 - M

ITALY



## Lavabi freestanding

Freestanding washbasins / Lavabos colonne / Freistehende waschbecken

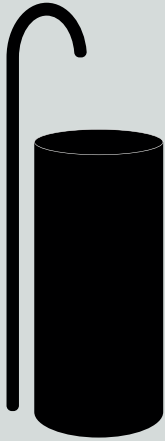

## Momon

### Lavabo centro stanza con foro rubinetto, completo di piletta a scarico libero

53559.26

Pedestal washbasin, with tap hole, with freeflow waste water drain  
Lavabo colonne, avec perçage de robinetterie, bonde à écoulement libre  
Pedestal Waschbecken mit Hahnloch und freie Ablaufgarnitur

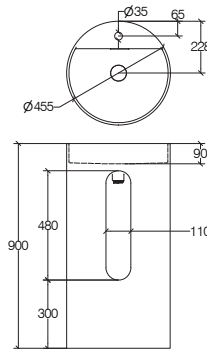

Mattstone  
Mattstone  
Mattstone  
Mattstone



.26

€ 1322,00 - L

### Lavabo centro stanza senza foro rubinetto, completo di piletta a scarico libero e sifone a pavimento

53560.26

Pedestal washbasin, without tap hole, with free waste water drain and floor siphon  
Lavabo colonne sans trou de robinetterie, avec bonde à écoulement libre et siphon au sol  
Pedestal Waschbecken ohne Hahnloch mit freie Ablaufgarnitur und Siphon am Boden

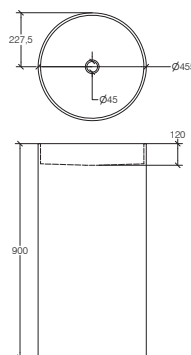

Mattstone  
Mattstone  
Mattstone  
Mattstone



.26

senza foro rubinetto  
without tap hole  
sans trou de robinetterie  
ohne loch für armatur

€ 1322,00 - L



**Struttura freestanding per lavabo 53564.26**

Freestanding structure for washbasin 53564.26 / Structure indépendante pour vasque 53564.26  
Freistehende Struktur für Aufsatzbecken 53564.26

**6663.22**

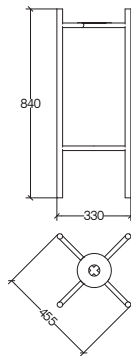

**Acciaio verniciato**  
Painted steel  
Acier peint  
Lackierter Stahl



.22

€ 508,00 - M

**Lavabo da appoggio con piletta a scarico libero**

Countertop washbasin with freeflow wastewater drain / Vasque à poser avec bonde à écoulement libre  
Aufsatzbecken mit freie Ablaufgarnitur

**53564.26**

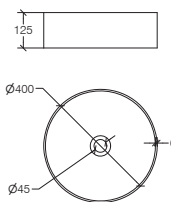

**Mattstone**  
Mattstone  
Mattstone  
Mattstone



.26

€ 419,00 - M

**Mensola**

Shelf / Étagère / Ablage

**66631.26**

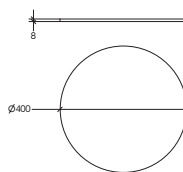

**Mattstone**  
Mattstone  
Mattstone  
Mattstone



.26

€ 123,00 - M



€ 1050,00 - L



## Lavabi ad incasso

Built-in washbasins / Lavabos encastrés / Einbauwaschbecken

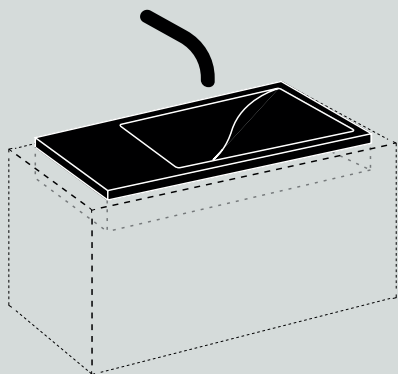

## Acquaio - Grela

---

### Acquaio

**53593.29**

#### Vasca da incasso

Built-in washbasin  
Lavabo à encastrer  
Einbauwaschtisch



acciaio inox  
stainless steel  
acier inoxydable  
rostfreier stahl



€ 130,00 - S

---

### Acquaio

**53663.29**

#### Vasca da incasso

Built-in washbasin  
Lavabo à encastrer  
Einbauwaschtisch



acciaio inox  
stainless steel  
acier inoxydable  
rostfreier stahl



€ 223,00 - S

---

### Grela

**53570.26 + GRELA 8220**

#### Lavabo da incasso

Built-in washbasin  
Lavabo à encastrer  
Einbauwaschtisch



Mineralmarmo opaco  
Matt mineralmarmo  
Minéral marbre mat  
Mineralmarmo matte



€ 194,00 - M

**Per tutte le altre misure dei lavabi in Mineralmarmo da incasso vedi pag. 206-209-211**

For all other sizes see pages: 206-209-211

Pour toutes les autres dimensions voir pages : 206-209-211

Für alle anderen Größen siehe Seiten: 206-209-211

**Ricambi / Spare parts / Pièces détachées / Ersatzteile**

<b>53553</b>	R2253599	Spugna abrasiva - Abrasive sponge	<b>4,00</b>
<b>53559</b>	R2253599	Spugna abrasiva - Abrasive sponge	<b>4,00</b>
<b>53560</b>	R2253599	Spugna abrasiva - Abrasive sponge	<b>4,00</b>
<b>53563</b>	R2253599	Spugna abrasiva - Abrasive sponge	<b>4,00</b>
<b>53564</b>	R2253599	Spugna abrasiva - Abrasive sponge	<b>4,00</b>
<b>53593</b>	R2253601	Kit troppopieno - Overflow set	<b>15,00</b>
<b>53663</b>	R2253601	Kit troppopieno - Overflow set	<b>15,00</b>



# specchi & lampade

*Mirrors and Lamps / Miroirs et Lampes / Spiegel und Lampen*

**Specchi / 278**

*Mirrors / Miroirs / Spiegel*

**Specchi illuminati / 286**

*Mirrors with lighting / Miroirs avec lumière / Spiegel mit licht*

**Specchi ingranditori / 290**

*Magnifying mirrors / Miroirs grossissants / Wand-Vergrößerungsspiegel*

**Lampade / 298**

*Lamps / Lampes / Lampen*







## **Specchi**

*Mirrors / Miroirs / Spiegel*



## Speci

### Specchio con cornice

Mirror with frame / Miroir avec encadrement / Spiegel mit Rahmen

5676.nn

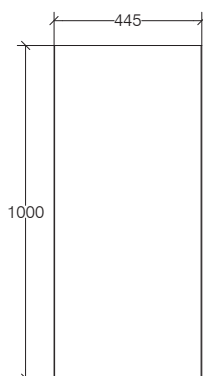

Alluminio verniciato  
Painted aluminium  
Aluminium laqué  
Lackiertem Aluminium



€ 185,00 - S

### Specchio con luce LED e mensola

Mirror with LED lighting and shelf / Miroir avec étagère et lumière LED / Spiegel mit LED Licht und Ablage

5689.nn

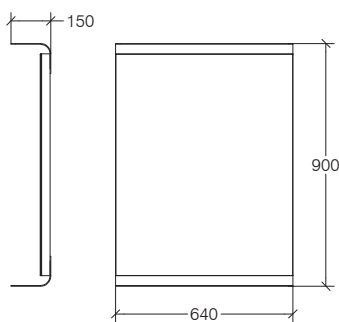

Alluminio verniciato  
Painted aluminium  
Aluminium laqué  
Lackiertem Aluminium



€ 464,00 - M



**Specchio con cornice**

Mirror with frame / Miroir avec encadrement / Spiegel mit Rahmen

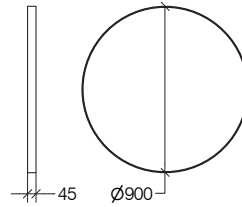
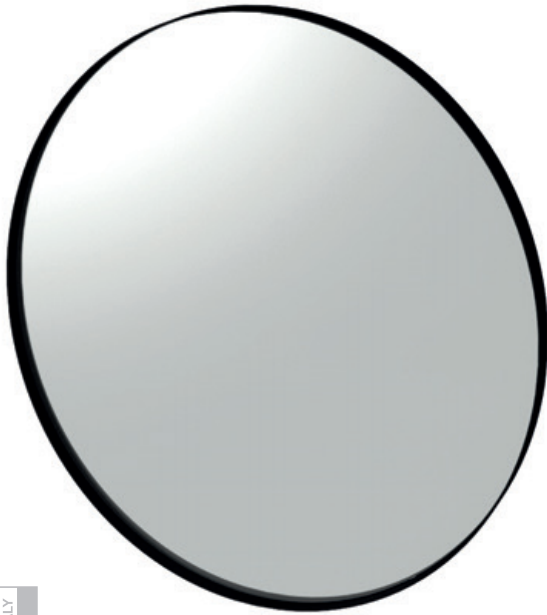
**5692.22**

**Resina verniciata nera**  
*Black painted resin*  
*Résine laqué noir*  
*Lackiertem Harz Schwarz*

**.22**

€ 541,00 - L

**Specchio con cornice**

Mirror with frame / Miroir avec encadrement / Spiegel mit Rahmen

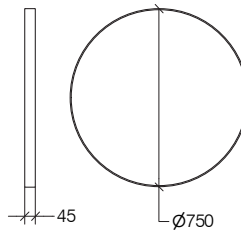
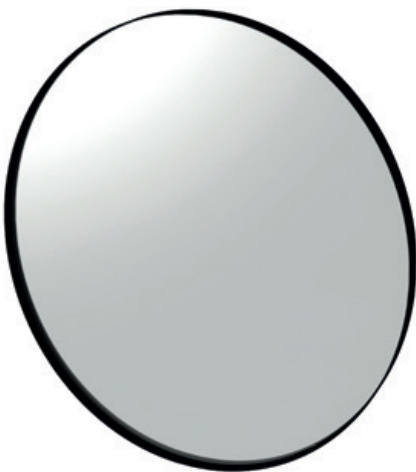
**5693.22**

**Resina verniciata nera**  
*Black painted resin*  
*Résine laqué noir*  
*Lackiertem Harz Schwarz*

**.22**

€ 521,00 - L

**Specchio ingranditore magnetico 5x con cornice (abbinabile con gli specchi 5692.22 e 5693.22)**

5x magnetic magnifying mirror with frame (suitable with 5692.22 and 5693.22)

Miroir grossissant magnétique 5x, avec encadrement (à combiner avec miroirs 5692.22 et 5693.22)

Vergrößerungsspiegel mit behälter (passend zum spiegel 5692.22 und 5693.22)

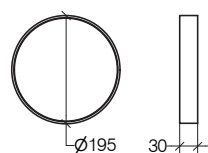
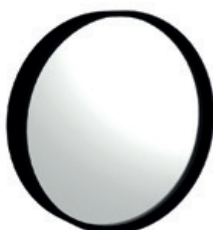
**56921.22**

**Resina verniciata nera**  
*Black painted resin*  
*Résine laqué noir*  
*Lackiertem Harz Schwarz*

**.22**

€ 169,00 - L

## Speci

### Specchio rotante filo lucido con fissaggio da piano, lato posteriore in acciaio inox

56683.29

Revolving polished sides mirror with top fixing, back side in stainless steel

Miroir pivotant, fixation au sol, arrière en acier

Drehbarer Spiegel für Tisch Montage, Rückseite auf Edelstahl

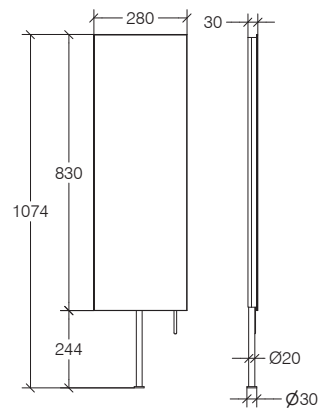

Specchio  
Mirror  
Miroir  
Spiegel



.29

**Specchio filo lucido orientabile**

Adjustable mirror / Miroir orientable / Verstellbar Spiegel

**56685.29**

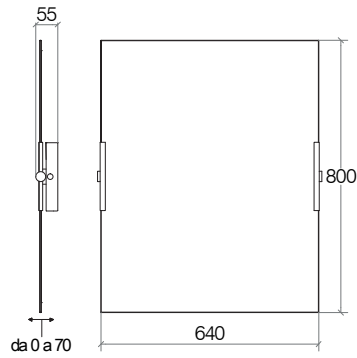

Specchio  
Mirror  
Miroir  
Spiegel



.29



€ 254,00 - M

**Specchio filo lucido orientabile**

Adjustable mirror / Miroir orientable / Verstellbar Spiegel

**56686.29**

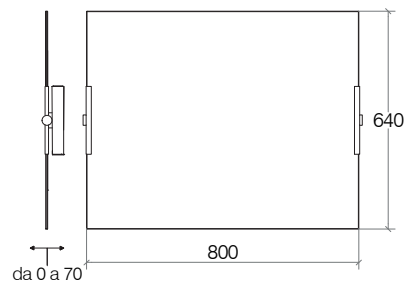

Specchio  
Mirror  
Miroir  
Spiegel



.29



€ 254,00 - M

## Speci

### Specchio tondo

Round mirror / Miroir rond / Runder Spiegel

56300

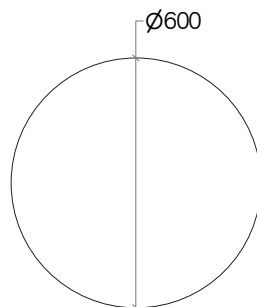

Specchio  
Mirror  
Miroir  
Spiegel



€ 130,00 - S

### Specchio ovale

Oval mirror / Miroir oval / Ovaler Spiegel

56301

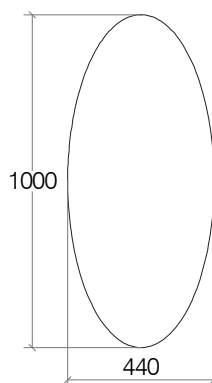

Specchio  
Mirror  
Miroir  
Spiegel



€ 145,00 - M

**Specchio quadro**

Square mirror / Miroir carré / Rechteckiger Spiegel

**56302**

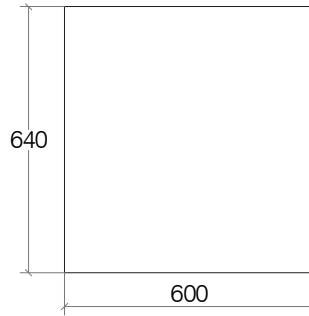

Specchio  
Mirror  
Miroir  
Spiegel



€ 107,00 - M

**Specchio reversibile**

Reversible mirror / Miroir réversible / Reversibeler Spiegel

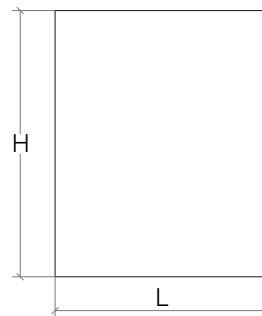
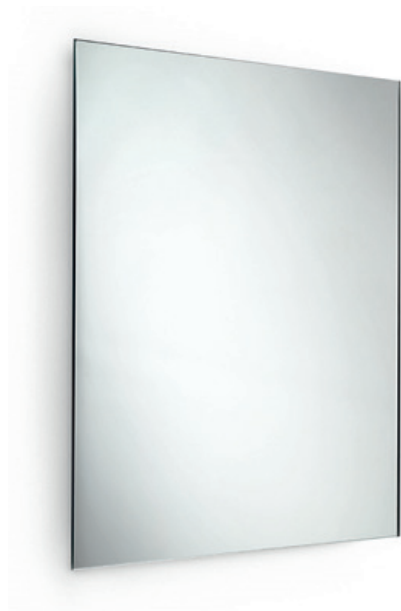

Specchio  
Mirror  
Miroir  
Spiegel



Cod.	H mm.	L mm.	P mm.	Sp mm.	€
<b>56303</b>	640	800	30	4	<b>113,00</b>
<b>56304</b>	640	900	30	4	<b>120,00</b>
<b>56305</b>	640	1000	30	4	<b>125,00</b>
<b>56306</b>	640	1200	30	4	<b>148,00</b>
<b>56307</b>	640	1300	30	4	<b>155,00</b>



**Speci**

**Specchio molato reversibile**

Reversible mirror / Miroir réversible / Reversibeler Spiegel

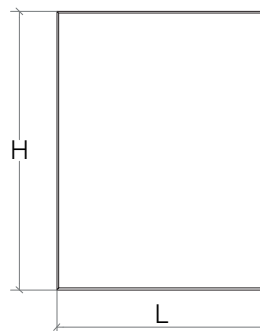

Specchio  
Mirror  
Miroir  
Spiegel



Cod.	H mm.	L mm.	P mm.	Sp mm.	€
<b>56308</b>	640	600	30	4	<b>138,00</b>
<b>56309</b>	640	800	30	4	<b>145,00</b>
<b>56310</b>	640	900	30	4	<b>154,00</b>
<b>56311</b>	640	1000	30	4	<b>164,00</b>
<b>56312</b>	640	1200	30	4	<b>191,00</b>
<b>56313</b>	640	1300	30	4	<b>201,00</b>
<b>56314</b>	640	450	30	4	<b>126,00</b>



**Specchio con luce LED, accensione a sensore touch con regolatore di luce**

**56851**

Mirror with LED lighting, touch sensor switch and dimmer  
Miroir avec lumière LED, allumage par touch avec régulateur de lumière  
Spiegel , Led Licht, Touch Einschalten, Lichtregler

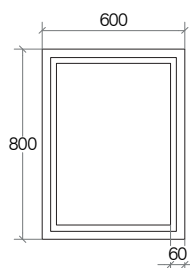

Specchio  
Mirror  
Miroir  
Spiegel



**IP44**   **CE**   **4000° K**

€ 410,00 - M



**Specchio luce LED cornice illuminata**

Framed mirror with LED lighting / Miroir avec lumière LED / Spiegel mit LED Beleuchtung Rahmen

**5671**

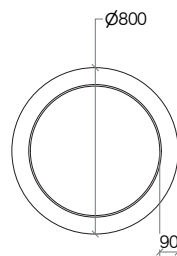

Specchio  
Mirror  
Miroir  
Spiegel



**IP44** **CE** **4000° K**

€ 584,00 - M

**Specchio luce LED cornice illuminata**

Framed mirror with LED lighting / Miroir avec lumière LED / Spiegel mit LED Beleuchtung Rahmen

**5672**

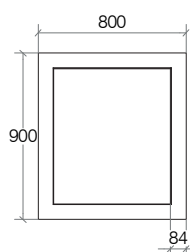

Specchio  
Mirror  
Miroir  
Spiegel



**IP44** **CE** **4000° K**

€ 540,00 - M



**Speci**

**Specchio con luce LED**

Mirror with LED lighting / Miroir avec lumière LED / Spiegel mit LED Beleuchtung

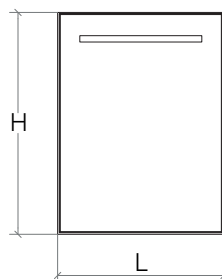
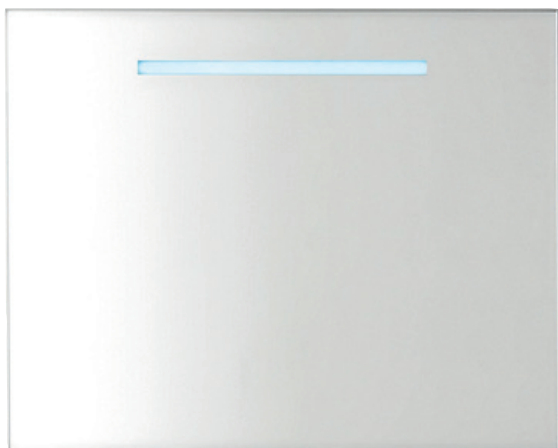

**Specchio**  
Mirror  
Miroir  
Spiegel



Cod.	H mm.	L mm.	P mm.	Sp mm.	€
<b>56707</b>	800	600	26	4	247,00
<b>56708</b>	800	800	26	4	275,00
<b>56709</b>	800	1000	26	4	306,00
<b>56710</b>	800	1200	26	4	338,00



**IP44** **CE** **4000° K**

**NEW**

Specchi illuminati / Mirrors with lighting / Miroirs avec lumière / Spiegel mit licht

**Speci**

**Specchio molato**

Grinding mirror / Miroir biseauté / Schleifspiegel

**56315**

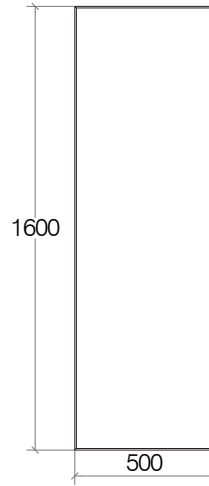

Specchio  
Mirror  
Miroir  
Spiegel



€ 215,00 - M

**Specchio luce LED cornice illuminata**

Framed mirror with LED lighting / Miroir avec lumière LED / Spiegel mit LED Beleuchtung Rahmen

**56711**

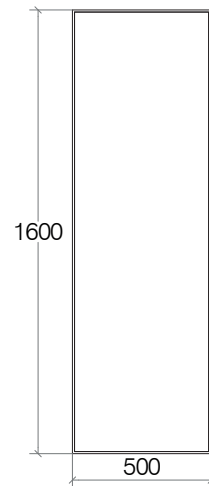

Specchio  
Mirror  
Miroir  
Spiegel



**IP44** **CE** **4000° K**

€ 660,00 - L



## Specchi ingranditori

Magnifying mirrors / Miroirs grossissants / Wand-Vergrößerungsspiegel

### IT

**Mevedo:**  
mi vedo.

Dai classici specchi quadrati o rettangolari da tavolo, a quelli rotondi estensibili e a parete: gli alleati per il make up e la cura del viso.

Ottone cromato

### EN

**Mevedo:**  
*I see myself.*

*From the classic square or rectangular table mirrors to the extensible round and wall mirrors: the perfect allies for make up and face care.*

*Chromed brass*

### FR

**Mevedo :**  
*Je me vois.*

*Des classiques miroirs à poser carrés ou rectangulaires, aux miroirs ronds extensibles et muraux : les alliés du maquillage et du soin du visage.*

*Laiton chromé*

### DE

**Mevedo:**  
*ich sehe mich.*

*Von den klassischen quadratischen und rechteckigen Tischspiegeln bis zu den erweiterbaren Rundspiegeln und Wandspiegeln: die Verbündeten für das Make-up und die Gesichtspflege.*

*Verchromtes Messing*



## Mevedo

### Specchio ingranditore a parete

Wall magnifying mirror / Miroir grossissant mural / Vergrößerungsspiegel Wandmodell

**5588.29**

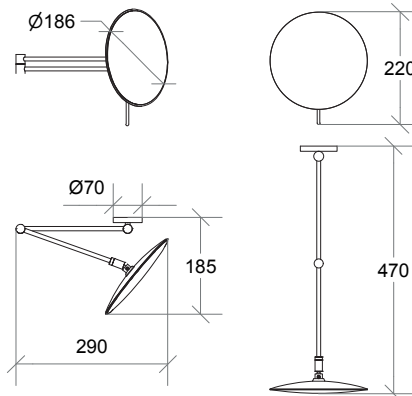

Ottone cromato  
Chromed brass  
Laiton chromé  
Verchromtes Messing



.29

3x

€ 114,00 - M

### Specchio ingranditore orientabile a parete

Wall magnifying mirror / Miroir grossissant mural / Vergrößerungsspiegel Wandmodell

**5591.29**

**5591.29.5X**

**5591.29.8X**

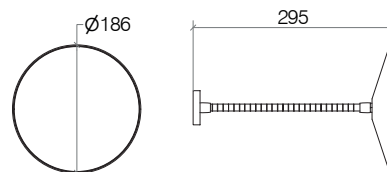

Ottone cromato  
Chromed brass  
Laiton chromé  
Verchromtes Messing



.29

3x 5x 8x

Disponibile .3X magnifying .5X magnifying e .8X magnifying  
Available also / Disponible en / Verfügbar also

€ 87,00 - M

### Specchio ingranditore orientabile da appoggio

Magnifying table mirror / Miroir grossissant à poser / Vergrößerungsspiegel Standmodell

**5592.29**

**5592.29.5X**

**5592.29.8X**

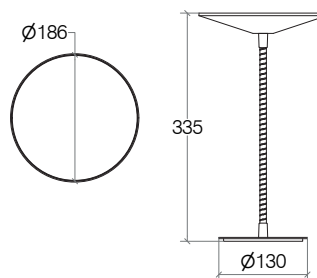

Ottone cromato  
Chromed brass  
Laiton chromé  
Verchromtes Messing



.29

3x 5x 8x

Disponibile .3X magnifying .5X magnifying e .8X magnifying  
Available also / Disponible en / Verfügbar also

€ 120,00 - M

**Specchio ingranditore da appoggio**

Magnifying table mirror / Miroir grossissant à poser / Vergrößerungsspiegel Standmodell

**5593.29**

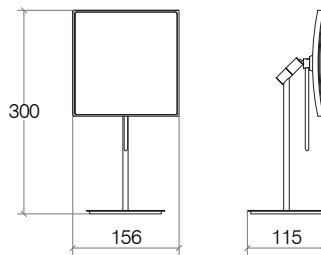

**Ottone cromato**  
Chromed brass  
Laiton chromé  
Verchromtes Messing



.29

3x

€ 128,00 - M

**Specchio ingranditore da appoggio**

Magnifying table mirror / Miroir grossissant à poser / Vergrößerungsspiegel Standmodell

**5594.29**

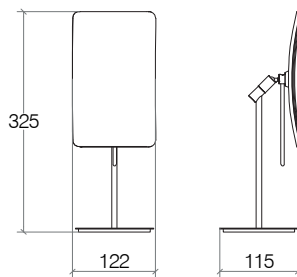

**Ottone cromato**  
Chromed brass  
Laiton chromé  
Verchromtes Messing



.29

3x

€ 128,00 - M

**Specchio ingranditore a parete**

Wall magnifying mirror / Miroir grossissant mural / Vergrößerungsspiegel Wandmodell

**5595.29**

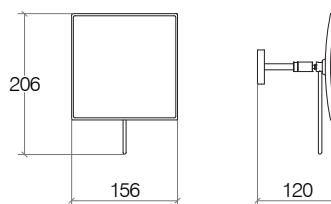

**Ottone cromato**  
Chromed brass  
Laiton chromé  
Verchromtes Messing



.29

3x

€ 91,00 - M

## Mevedo

### Specchio ingranditore da appoggio

Magnifying table mirror / Miroir grossissant à poser / Vergrößerungsspiegel Standmodell

**55943.29**

**55943.29.5X**

**55943.29.8X**

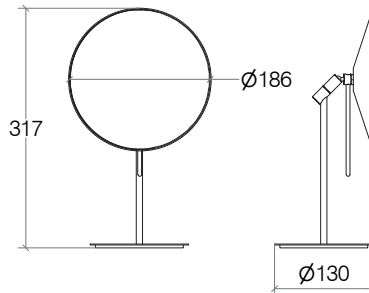

Ottone cromato  
Chromed brass  
Laiton chromé  
Verchromtes Messing



.29

3x

5x

8x

Disponibile .3X magnifying .5X magnifying e .8X magnifying  
Available also / Disponible en / Verfügbar also

€ 123,00 - M

### Specchio ingranditore a parete

Wall magnifying mirror / Miroir grossissant mural / Vergrößerungsspiegel Wandmodell

**5596.29**

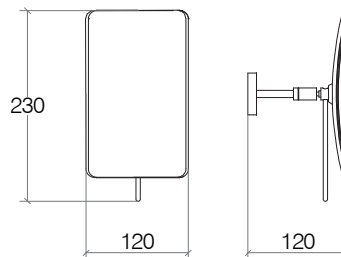

Ottone cromato  
Chromed brass  
Laiton chromé  
Verchromtes Messing



.29

3x

€ 91,00 - M

### Specchio ingranditore a parete

Wall magnifying mirror / Miroir grossissant mural / Vergrößerungsspiegel Wandmodell

**55963.29**

**55963.29.5X**

**55963.29.8X**

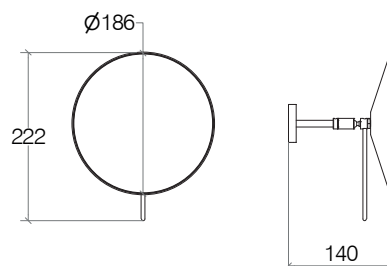

Ottone cromato  
Chromed brass  
Laiton chromé  
Verchromtes Messing



.29

3x

5x

8x

Disponibile .3X magnifying .5X magnifying e .8X magnifying  
Available also / Disponible en / Verfügbar also

€ 91,00 - M



**Specchio ingranditore 1 lato riflettente ed 1 lato ingrandente, da appoggio**

Table mirror, 1 side magnifying, 1side true image / Miroir grossissant et normal (2 faces), à poser  
Vergrößerungsspiegel (nur eine Seite Vergrößerung) Standmodell

**55851.29**

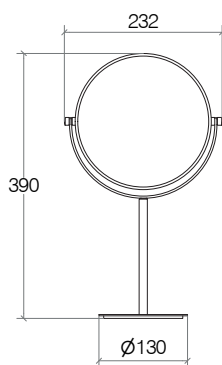

Ottone cromato  
Chromed brass  
Laiton chromé  
Verchromtes Messing



.29



€ 128,00 - M

**Specchio ingranditore 1 lato riflettente ed 1 lato ingrandente 3X, a parete**

Wall mirror, 1 side magnifying 3X, 1 side true image / Miroir grossissant 3X et normal (2 faces), mural  
Vergrößerungsspiegel (nur eine Seite Vergrößerung 3X) Wandmodell

**55852.29**

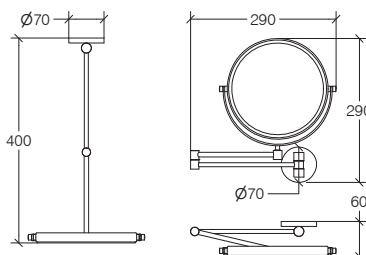

Ottone cromato  
Chromed brass  
Laiton chromé  
Verchromtes Messing



.29



€ 128,00 - M

**Specchio ingranditore con luce LED da appoggio**

Magnifying table mirror with LED light / Miroir grossissant à poser avec lumière LED  
Vergrößerungsspiegel LED Licht Standmodell

**55860.29**

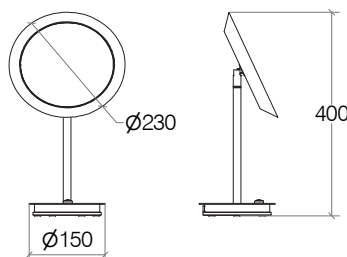

Ottone cromato  
Chromed brass  
Laiton chromé  
Verchromtes Messing



.29



IP44 CE

€ 230,00 - L

## Mevedo

### Specchio ingranditore luce LED a parete

55861.29

Magnifying wall mirror with LED light / Miroir grossissant mural avec lumière LED  
Vergrößerungsspiegel LED Licht Wandmodell

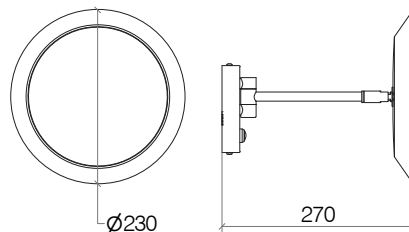
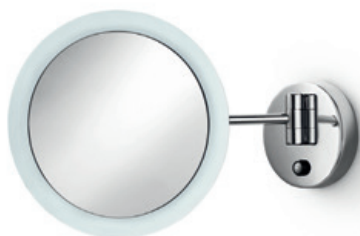

Ottone cromato  
Chromed brass  
Laiton chromé  
Verchromtes Messing



.29



IP44 CE

€ 240,00 - L

### Specchio ingranditore da appoggio con contenitore

55864.nn

Magnifying table mirror with container / Miroir grossissant à poser avec rangement / Vergrößerungsspiegel mit Container

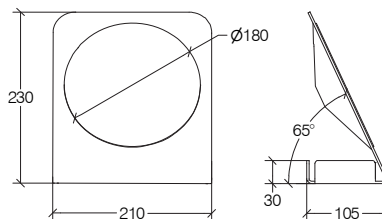

Alluminio verniciato  
Painted aluminium  
Aluminium laqué  
Lackiertem Aluminium

Acciaio inox lucido  
Polished stainless steel  
Acier inoxydable brillant  
Poliert Edelstahl



.09

.17

.18

€ 111,00 - M



.29

€ 155,00 - M





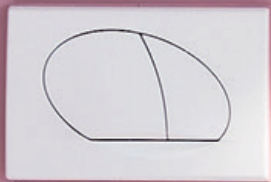

THINK  
OUTSIDE  
THE BOX

## Lampade

Lamps / Lampes / Lampen

### IT

**Mevedo:**  
mi vedo.

Dai classici specchi quadrati o rettangolari da tavolo, a quelli rotondi estensibili e a parete: gli alleati per il make up e la cura del viso.

Ottone cromato

### EN

**Mevedo:**  
*I see myself.*

*From the classic square or rectangular table mirrors to the extensible round and wall mirrors: the perfect allies for make up and face care.*

*Chromed brass*

### FR

**Mevedo :**  
*Je me vois.*

*Des classiques miroirs à poser carrés ou rectangulaires, aux miroirs ronds extensibles et muraux : les alliés du maquillage et du soin du visage.*

*Laiton chromé*

### DE

**Mevedo:**  
*ich sehe mich.*

*Von den klassischen quadratischen und rechteckigen Tischspiegeln bis zu den erweiterbaren Rundspiegeln und Wandspiegeln: die Verbündeten für das Make-up und die Gesichtspflege.*

*Verchromtes Messing*



## Ciari

### Lampada LED a specchio

LED lamp to fix on mirror / Lampe LED pour miroir / Spiegelleuchte LED

5720.29

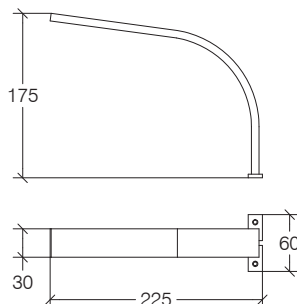

Alluminio cromato  
Chromed aluminium  
Aluminium chromé  
Verchromtes Aluminium



.29



IP44



4000° K

€ 83,00 - S

### Lampada LED a specchio

LED lamp to fix on mirror / Lampe LED pour miroir / Spiegelleuchte LED

5721.29

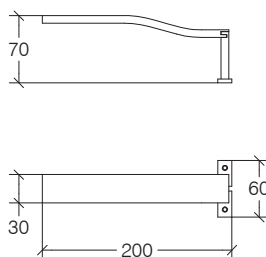

Alluminio cromato  
Chromed aluminium  
Aluminium chromé  
Verchromtes Aluminium



.29



IP44



4000° K

€ 83,00 - S

### Lampada LED a specchio

LED lamp to fix on mirror / Lampe LED pour miroir / Spiegelleuchte LED

5722.29

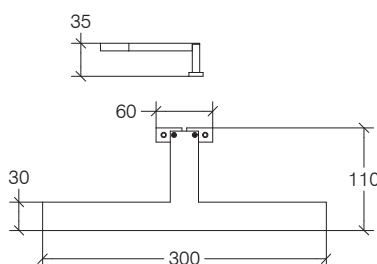

Alluminio cromato  
Chromed aluminium  
Aluminium chromé  
Verchromtes Aluminium



.29



IP44



4000° K

€ 94,00 - S

**Lampada LED a specchio**

LED lamp to fix on mirror / Lampe LED pour miroir / Spiegelleuchte LED

**5723.29**

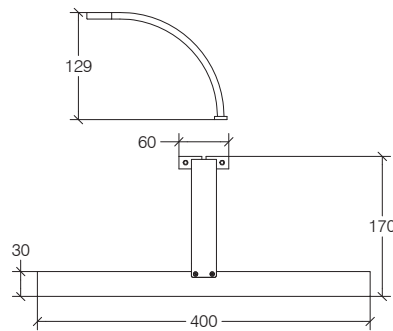

**Alluminio cromato**  
Chromed aluminium  
Aluminium chromé  
Verchromtes Aluminium



LED IP44 CE □ 4000° K

€ 99,00 - S

**Lampada LED applique a parete reversibile**

Reversible LED wall lamp / Lampe LED mural réversible / Reversibeler LED-Wandleuchte

**5729.18**

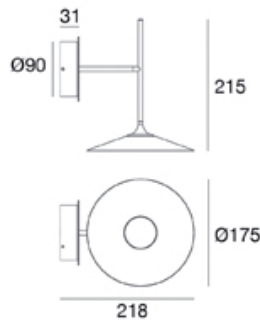

**Alluminio verniciato**  
Painted aluminium  
Aluminium laqué  
Lackiertem Aluminium



LED IP44 CE □ 3000° K

€ 151,00 - M

**Lampada LED sospensione a soffitto**

Pendant LED lamp / Lampe LED à suspendre / Hängende LED-Lampe

**5730.nn**



**Alluminio verniciato**  
Painted aluminium  
Aluminium laqué  
Lackiertem Aluminium



LED IP44 CE □ 3000° K

€ 131,00 - M

**Ciari**

**5731.18**

**Lampada LED sospensione a soffitto**

Pendant LED lamp  
Lampe LED à suspendre  
Hängende LED-Lampe

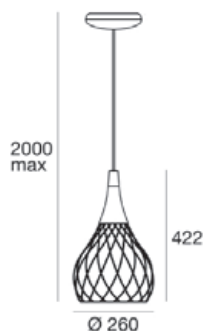

**Alluminio verniciato**  
*Painted aluminium*  
*Aluminium laqué*  
*Lackiertem Aluminium*



**.18**



**IP44**



**3000° K**

€ 490,00 - L

**Lampada LED applique a parete con luce orientabile**

Wall LED lamp with light swivelling  
Lampe LED murale avec lumière orientable  
LED-Wandleuchte mit licht Schwenkbarkeit

**5732.nn**

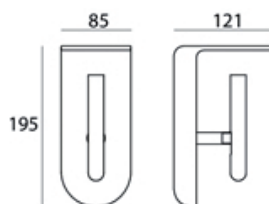

**Alluminio verniciato**  
*Painted aluminium*  
*Aluminium laqué*  
*Lackiertem Aluminium*



**.09**



**.18**



**IP44**



€ 286,00 - L



**NEW**

Lampade / Lamps / Lampes / Lampen

**Ciari**



## I NOSTRI MARCHI DI SICUREZZA

**CODICE IP (EN 60529)**

Sistema che indica i gradi di protezione di un involucro contro l'accesso a parti pericolose, la penetrazione di corpi solidi, e/o l'ingresso di acqua.

**PROTEZIONE CONTRO L'INGRESSO DI SOLIDI**

**IP0X** non protetto

**IP1X** contro corpi estranei > 50 mm

**IP2X** contro corpi estranei > 12 mm

**IP3X** contro corpi estranei > 2,5 mm **IP4X** contro corpi estranei > 1 mm

**IP5X** protezione da polvere

**IP6X** stagno alla polvere

**PROTEZIONE CONTRO L'INGRESSO DI LIQUIDI**

**IPX0** non protetto

**IPX1** contro la caduta vertical di gocce

**IPX2** contro caduta acqua con inclinazione 15°

**IPX3** contro la pioggia

**IPX4** contro gli spruzzi

**IPX5** contro i getti acqua

**IPX6** contro i getti potenti

**IPX7** contro l'immersione temporanea

**IPX8** contro l'immersione continua

**CERTIFICAZIONI**

TUV Rheinland GS è un certificato fornito dal produttore che attesta l'ammissione in Europa. Dimostrando la totale conformità con GPSG (legge tedesca sulla sicurezza del prodotto) per la Germania, ma anche dimostra la conformità con l'LVD, legge dell' unione europea che assicura che un apparecchio elettrico con certi limiti di voltaggio, offre comunque un alto livello di protezione.

**CLASSI DI ISOLAMENTO****CLASSE I**

La protezione non si basa unicamente sull'isolamento principale, ma anche su una misura di sicurezza supplementare

costituita dalla connessione delle parti conduttrici accessibili ad un conduttore di protezione (messa a terra di protezione) che fa capo all'impianto elettrico fisso, in modo tale che le parti conduttrici accessibili non possano andare in tensione in caso di guasto dell'isolamento principale.

**CLASSE II**

Gli apparecchi di classe II sono progettati in modo da non richiedere la connessione di messa a terra. Sono costruiti in modo che un singolo guasto non possa causare il contatto con tensioni pericolose da parte dell'utilizzatore. Ciò è ottenuto realizzando l'involucro del contenitore in materiali isolanti, o comunque facendo in modo che le parti in tensione siano circondate da un doppio strato di materiale isolante o usando isolamenti rinforzati.

**CLASSE III**

Un apparecchio viene definito di Classe III quando la protezione contro la folgorazione si affida al fatto che non sono presenti tensioni superiori alla Bassissima tensione di sicurezza SELV (Safety Extra-Low Voltage). In pratica tale apparecchio viene alimentato o da una batteria o da un trasformatore SELV.

**CE NORMATIVE TECNICHE**

Le direttive 89/336/CEE e 73/23/CEE stabiliscono i requisiti essenziali di sicurezza e compatibilità elettromagnetica a cui devono rispondere i materiali elettrici per poter circolare liberamente all'interno del mercato Europeo. Questi requisiti devono essere verificati mediante opportune prove tecniche e la conformità del materiale deve essere indicata mediante l'apposizione del marchio CE sul prodotto o sul suo imballo. La marchiatura è obbligatoria ed il produttore è direttamente responsabile della rispondenza del prodotto ai requisiti essenziali delle direttive sopracitate. La vendita, la commercializzazione e l'acquisto di prodotti privi della marcatura, e quindi non rispondenti alle direttive, è punita a termini di legge.

**ZONE DI SICUREZZA**

Tutti gli apparecchi elettrici vanno collegati al circuito mantenendo una distanza minima di 0,60 m da lavabi, cabine doccia, vasche e 1,20 m da soffioni doccia.

## OUR SAFETY MARKS



## IP CODE (EN 60529)

A coding system to indicate the degree of protection provided by an enclosure against accessing of solid foreign objects and/or water.

## PROTECTION AGAINST THE INGRESS OF SOLIDS

**IP0X** not protected

**IP1X** against solid foreign objects > 50 mm

**IP2X** against solid foreign objects > 12 mm

**IP3X** against solid foreign objects > 2,5 mm  
**IP4X** against solid foreign objects > 1 mm

**IP5X** dust protected

**IP6X** dust-tight

## PROTECTION AGAINST THE INGRESS OF LIQUIDS

**IPX0** not protected

**IPX1** against vertically dripping

**IPX2** against 15° tilted dripping

**IPX3** rain protected

**IPX4** splashing protected

**IPX5** jetting protected

**IPX6** powerful jetting protected

**IPX7** against temporary immersion

**IPX8** against continuous immersion



## CERTIFICATES

The TÜV Rheinland GS is a certificate presented by manufacturers as the proof for acceptance into Europe. It demonstrates full compliance with the GPSG (German equipment safety law) for Germany, but it also demonstrates compliance to the LVD that ensures that electrical equipment within certain voltage limits provides a high level of protection in the

## CLASS LUMINAIRES

 CLASSE I

Provide protection against electrical shock solely using the base insulation and the safe connection of all exposed conductive parts to an earth conductor.

 CLASSE II

Provide protection against electrical shock using both the base insulation and an additional or reinforced insulation. This kind of products do not feature a connection to a protective earth conductor.

 CLASSE III

Luminaires provide protection against electrical shock by using Safety Extra Low Voltage (SELV). This kind of products are not permitted to generate higher voltages than the Safety Extra Low Voltage.

 NORMATIVE NOTES

The directives 89/336/EEC and 73/23/EEC establish the essential requirements for safety and electromagnetic compatibility that the electric and electronic equipment shall comply for freely circulating in the European market. These requirements must be verified by appropriate tests and compliance of the material must be indicated by the CE marking on the product or its packaging. This marking is mandatory and the producer is directly responsible for product compliance with the essential requirements of the abovementioned Directives. The sale, marketing and purchase of products without the markup, and therefore not meet the guidelines, shall be punished by law.

## SAFETY ZONES

Electric appliances must be wired to the electric circuit in a minimum distance of 0,60 m from shower cabins, bath tubs, washbasins and of 1,20 m from shower heads.



## LABELS DE SÉCURITÉ

**CODE IP (EN 60529)**

Label qui indique les degrés de protection d'un emballage contre l'accès à des parties dangereuses, la pénétration de corps solides, et/ou la pénétration de l'eau.

**PROTECTION CONTRE LA PÉNÉTRATION DE SOLIDES****IP0X non protégé****IP1X contre les corps étrangers > 50 mm****IP2X contre les corps étrangers > 12 mm****IP3X contre les corps étrangers > 2,5 mm****IP4X contre les corps étrangers > 1 mm****IP5X protection contre la poussière****IP6X étanche à la poussière****PROTECTION CONTRE LA PÉNÉTRATION DE LIQUIDES****IPX0 non protégé****IPX1 contre la chute verticale de gouttes****IPX2 contre la chute d'eau à 15° d'inclinaison****IPX3 contre la pluie****IPX4 contre les éclaboussures****IPX5 contre les jets d'eau****IPX6 contre les jets puissants****IPX7 contre l'immersion temporaire****IPX8 contre l'immersion continue****CERTIFICATIONS**

TUV Rheinland GS est un certificat fourni par le producteur qui atteste l'admission en Europe. En démontrant la totale conformité au GPSG (loi allemande sur la sécurité du produit) pour l'Allemagne, elle démontre aussi la conformité avec la LVD - loi de l'Union Européenne qui assure qu'un appareil électrique avec certaines limites de voltage offre tout de même un haut niveau de protection.

**CLASSES D'ISOLATION****CLASSE I**

La protection n'est pas seulement basée sur l'isolation principale, mais également sur une mesure de sécurité supplémentaire constituée de la connexion des parties conductrices accessibles à un conducteur de protection (protection vers la terre) qui est rattaché à l'installation électrique fixe, de sorte que les parties conductrices accessibles ne puissent être mises sous tension en cas de panne de l'isolation principale.

**CLASSE II**

Les dispositifs de classe II sont conçus de sorte à ne pas avoir besoin de connexion à la terre. Ils sont fabriqués de façon à ce qu'une simple panne ne puisse causer le contact avec des tensions dangereuses de la part de l'utilisateur. Ce résultat est obtenu en fabriquant l'enveloppe du conteneur en matériau isolant, ou, en tout état de fait, en faisant en sorte que les parties sous tension soit entourées d'une double couche de matériau isolant, ou en utilisant une isolations renforcées.

**CLASSE III**

Un appareil est défini de Classe III lorsque sa protection contre l'électrocution est due au fait qu'aucune tension supérieure à la tension basse de sécurité SELV (Safety Extra-Low Voltage) n'est présente. Dans la pratique, cet appareil est alimenté soit par une batterie, soit par un transformateur SELV.

**RÉGLEMENTATIONS TECHNIQUES**

Les directives 89/336/CEE et 73/23/CEE établissent les exigences essentielles de sécurité et compatibilité électromagnétique auxquelles doivent répondre les matériaux électriques afin de pouvoir circuler librement sur le marché européen. Ces exigences doivent être vérifiées par des tests techniques appropriés et la conformité du matériau doit être indiquée par l'apposition de la marque CE sur le produit ou sur son emballage. Le marquage est obligatoire et le producteur est directement responsable de l'adéquation du produit aux exigences essentielles des directives susmentionnées. La vente, la commercialisation et l'achat de produits privés de ce marquage, et donc ne répondant pas aux directives, est puni en terme de loi.

**ZONE DE SÉCURITÉ**

Tous les appareils électriques sont reliés au circuit en maintenant une distance minimale de 0,60 m des lavabos, cabines de douche, baignoires et de 1,20 m des pommeaux de douche.

**IP CODE (EN 60529)**

System, das den Grad der Schutzklasse für den Zugang zu gefährlichen Teilen anzeigt, um das Eindringen von Festkörpern und / oder das Eindringen von Wasser zu verhindern.

**SCHUTZ VOR DEM EINDRINGEN VON FESTSTOFFEN****IP0X ungeschützt****IP1X gegen Fremdkörper > 50 mm****IP2X gegen Fremdkörper > 12 mm****IP3X gegen Fremdkörper > 2,5 mm IP4X gegen Fremdkörper > 1 mm****IP5X Schutz vor Staub****IP6X staubdicht****SCHUTZ VORM EINDRINGEN VON FLÜSSIGKEITEN****IPX0 ungeschützt****IPX1 gegen den vertikalen Fall von Tropfen****IPX2 gegen fallende Wasser mit 15 ° Neigung****IPX3 gegen Regen****IPX4 gegen Spritzer****IPX5 gegen Strahlwasser****IPX6 gegen starken Strahl****IPX7 gegen zeitweiliges Untertauchen****IPX8 gegen dauerndes Untertauchen****ZERTIFIZIERUNGEN**

TÜV Rheinland GS ist ein Zertifikat vom Hersteller, um die Zulassung in Europa zu zertifizieren. Mit dem Nachweis voller Übereinstimmung mit der GPSG (deutsches Recht auf Sicherheitsprodukte) nicht nur für Deutschland, sondern auch in Übereinstimmung mit dem LVD, Gesetz ,der Europäischen Union zum Nachweis der Übereinstimmung, die ein elektrisches Gerät mit bestimmten Spannungsgrenzen gewährleistet, wobei ein hohes Niveau an Schutz geboten wird.

**ISOLIERKLASSEN****KLASSE I**

Der Schutz basiert nicht nur auf der Hauptisolation, sondern auch auf einer zusätzliche Sicherheitsmaßnahme durch die Verbindung der leitenden Teile über einem Schutzleiter (geerdet), der zur feststehenden elektrischen Installation gehört, in der Weise, dass leitfähige Teile nicht unter Spannung gesetzt werden, falls es zu einem Ausfall der Hauptisolation kommt.

**KLASSE II**

**Die Klasse-II-Geräte sind so konzipiert, damit sie keine Masseverbindung benötigen. Sie sind so konstruiert, dass ein einzelner Fehler nicht zum Kontakt mit gefährlichen Spannungen für den Benutzer führt. Dies wird durch die Konzeption des Behältermantels in Isoliermaterialien erreicht, oder auf andere Weise, so dass die stromführenden Teile durch eine Doppelschicht aus isolierendem Material oder durch Verwendung von verstärkter Isolierung umgeben sind.**

**KLASSE III**

Eine Einheit ist definiert als Klasse III, wenn der Schutz gegen elektrischen Schlag auf der Tatsache beruht, dass die Spannungen nur als sehr niedrige Sicherheitsspannungen SELV (Extra Low Voltage Safety) anliegen. In der Praxis wird dies durch eine Batterie oder durch einen SELV Transformator sichergestellt.

**CE TECHNISCHE STANDARDS**

Richtlinien 89/336 / EWG und 73/23 / EWG Festlegung der grundlegenden Sicherheitsanforderungen und EMV-Anforderungen für elektrische Materialien auf dem europäischen Markt. Diese Anforderungen müssen durch geeignete technische Tests und die Konformität des Materials überprüft werden, und werden angezeigt durch das CE-Zeichen auf dem Produkt oder der Verpackung. Die Kennzeichnung ist obligatorisch und der Hersteller ist direkt verantwortlich für die Produktkonformität mit den grundlegenden Anforderungen der oben genannten Richtlinien. Der Vertrieb, Marketing und der Kauf von Produkten ohne Beschriftung ist daher nicht im Einklang mit Richtlinien und strafbar.

**SICHERHEITSSZONE**

Alle elektrischen Geräte werden mit der Schaltung verbunden, indem ein Mindestabstand von 0,60 m von Waschbecken gehalten wird, von Duschkabinen und Badewannen und 1,20 m von Duschköpfen.



## Ricambi / Spare parts / Pièces détachées / Ersatzteile

<b>5689</b>	R2256202	Minuterie specchi 2 ganci + 4 viti + 4 tasselli - Hardware 2 hooks + 4 screws + 4 plugs	<b>5,00</b>
	R28112	Strip LED - LED strip	<b>57,00</b>
<b>5588</b>	R2555882	Kit ricambio specchio tondo completo - Round mirror kit	<b>56,00</b>
	R25559351	Snodo specchio 45° - Mirror 45° hinge	<b>12,00</b>
	R2555889	Braccio ingranditore completo - Entire magnifying arm	<b>65,00</b>
<b>5591</b>	R2555882	Kit ricambio specchio tondo completo - Round mirror kit	<b>56,00</b>
<b>5592</b>	R2555882	Kit ricambio specchio tondo completo - Round mirror kit	<b>56,00</b>
<b>5593</b>	R2555932	Kit ricambio specchio quadro completo - Square mirror kit	<b>56,00</b>
	R25559352	Snodo specchio - Mirror hinge	<b>12,00</b>
<b>5594</b>	R2555932	Kit ricambio specchio quadro completo - Square mirror kit	<b>56,00</b>
	R25559352	Snodo specchio - Mirror hinge	<b>12,00</b>
<b>55943</b>	R2555882	Kit ricambio specchio tondo completo - Round mirror kit	<b>56,00</b>
	R25559352	Snodo specchio - Mirror hinge	<b>12,00</b>
<b>5595</b>	R2555932	Kit ricambio specchio quadro completo - Square mirror kit	<b>56,00</b>
	R25559351	Snodo specchio 45° - Mirror 45° hinge	<b>12,00</b>
<b>5596</b>	R2555942	Kit ricambio specchio rettangolare completo - Rectangular mirror kit	<b>56,00</b>
	R25559351	Snodo specchio 45° - Mirror 45° hinge	<b>12,00</b>
<b>55963</b>	R2555882	Kit ricambio specchio tondo completo - Round mirror kit	<b>56,00</b>
	R25559351	Snodo specchio 45° - Mirror 45° hinge	<b>12,00</b>
<b>55851</b>	R25558515	Cornice completa con 2 specchi - Frame with 2 mirrors	<b>41,00</b>
	R25558513	Forcella U - Forked rod for mirror	<b>67,00</b>
<b>55852</b>	R25558515	Cornice completa con 2 specchi - Frame with 2 mirrors	<b>41,00</b>
	R25558522	Braccio completo - Entire arm	<b>67,00</b>
<b>5720</b>	R28200	Driver 3W - 3W driver	<b>24,00</b>
	R28110	Strip LED 3W - 3W LED strip	<b>19,00</b>
<b>5721</b>	R28200	Driver 3W - 3W driver	<b>24,00</b>
	R28110	Strip LED 3W - 3W LED strip	<b>19,00</b>
<b>5722</b>	R28201	Driver 6W - 6W driver	<b>30,00</b>
	R28111	Lampadina LED 6W - 6W LED lamp	<b>34,00</b>
<b>5723</b>	R28201	Driver 6W - 6W driver	<b>30,00</b>
	R28111	Lampadina LED 6W - 6W LED lamp	<b>34,00</b>
<b>56300</b>	R22563001	Minuterie specchi 1 gancio + 2 viti - Hardware 1 hook + 2 screws	<b>8,00</b>
	R22563003	Minuterie specchi distanziale maschio/femmina - Male/female mirror spacers	<b>8,00</b>

## Ricambi / Spare parts / Pièces détachées / Ersatzteile

<b>56301</b>	R22563001	Minuterie specchi 1 gancio + 2 viti - Hardware 1 hook + 2 screws	<b>8,00</b>
	R22563003	Minuterie specchi distanziale maschio/femmina - Male/female mirror spacers	<b>8,00</b>
<b>56302</b>	R22563001	Minuterie specchi 1 gancio + 2 viti - Hardware 1 hook + 2 screws	<b>8,00</b>
	R22563003	Minuterie specchi distanziale maschio/femmina - Male/female mirror spacers	<b>8,00</b>
<b>56303</b>	R22563001	Minuterie specchi 1 gancio + 2 viti - Hardware 1 hook + 2 screws	<b>8,00</b>
	R22563003	Minuterie specchi distanziale maschio/femmina - Male/female mirror spacers	<b>8,00</b>
<b>56304</b>	R22563001	Minuterie specchi 1 gancio + 2 viti - Hardware 1 hook + 2 screws	<b>8,00</b>
	R22563003	Minuterie specchi distanziale maschio/femmina - Male/female mirror spacers	<b>8,00</b>
<b>56305</b>	R22563001	Minuterie specchi 1 gancio + 2 viti - Hardware 1 hook + 2 screws	<b>8,00</b>
	R22563003	Minuterie specchi distanziale maschio/femmina - Male/female mirror spacers	<b>8,00</b>
<b>56306</b>	R22563002	Minuterie specchi 2 ganci + 4 viti - Hardware 2 hooks + 4 screws	<b>13,00</b>
	R22563003	Minuterie specchi distanziale maschio/femmina - Male/female mirror spacers	<b>8,00</b>
<b>56307</b>	R22563002	Minuterie specchi 2 ganci + 4 viti - Hardware 2 hooks + 4 screws	<b>13,00</b>
	R22563003	Minuterie specchi distanziale maschio/femmina - Male/female mirror spacers	<b>8,00</b>
<b>56308</b>	R22563001	Minuterie specchi 1 gancio + 2 viti - Hardware 1 hook + 2 screws	<b>8,00</b>
	R22563003	Minuterie specchi distanziale maschio/femmina - Male/female mirror spacers	<b>8,00</b>
<b>56309</b>	R22563001	Minuterie specchi 1 gancio + 2 viti - Hardware 1 hook + 2 screws	<b>8,00</b>
	R22563003	Minuterie specchi distanziale maschio/femmina - Male/female mirror spacers	<b>8,00</b>
<b>56310</b>	R22563001	Minuterie specchi 1 gancio + 2 viti - Hardware 1 hook + 2 screws	<b>8,00</b>
	R22563003	Minuterie specchi distanziale maschio/femmina - Male/female mirror spacers	<b>8,00</b>
<b>56311</b>	R22563001	Minuterie specchi 1 gancio + 2 viti - Hardware 1 hook + 2 screws	<b>8,00</b>
	R22563003	Minuterie specchi distanziale maschio/femmina - Male/female mirror spacers	<b>8,00</b>
<b>56312</b>	R22563002	Minuterie specchi 2 ganci + 4 viti - Hardware 2 hooks + 4 screws	<b>13,00</b>
	R22563003	Minuterie specchi distanziale maschio/femmina - Male/female mirror spacers	<b>8,00</b>
<b>56313</b>	R22563002	Minuterie specchi 2 ganci + 4 viti - Hardware 2 hooks + 4 screws	<b>13,00</b>
	R22563003	Minuterie specchi distanziale maschio/femmina - Male/female mirror spacers	<b>8,00</b>
<b>56314</b>	R22563001	Minuterie specchi 1 gancio + 2 viti - Hardware 1 hook + 2 screws	<b>8,00</b>
	R22563003	Minuterie specchi distanziale maschio/femmina - Male/female mirror spacers	<b>8,00</b>
<b>56315</b>	R22563002	Minuterie specchi 2 ganci + 4 viti - Hardware 2 hooks + 4 screws	<b>13,00</b>
	R22563003	Minuterie specchi distanziale maschio/femmina - Male/female mirror spacers	<b>8,00</b>



# termoarredi

*Design Radiators / Radiateurs / Heizkörper*

## **Termoarredi elettrici / 314**

*Electric radiators / Radiateurs électriques / Heizkörper elektrischer*

## **Termoarredi ad acqua / 316**

*Hydraulic radiators / Radiateurs hydrauliques / Heizkörper mit Wasser*

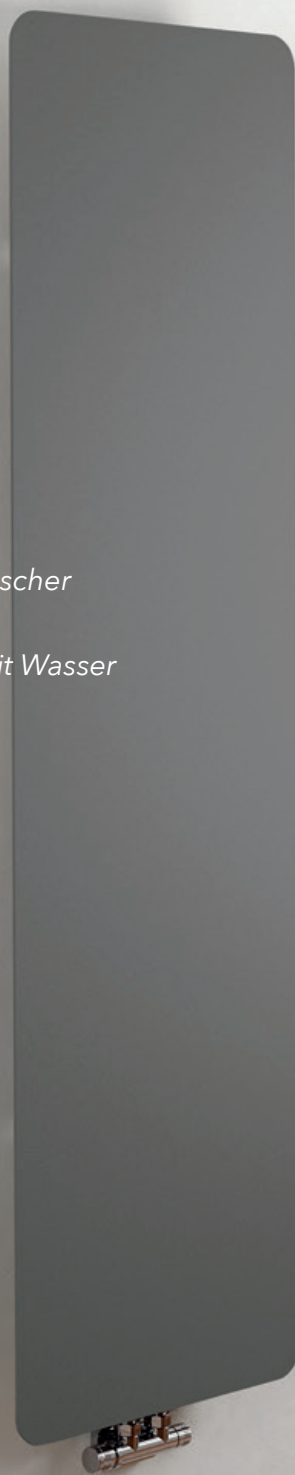





# 7

## Spessore 7 mm

*7 mm thickness 7 mm Dicke  
7 mm épaisseur*



## Design essenziale

*Essential design Schlichtes Design  
Design essentiel*



## Alta efficienza energetica

*High energy efficiency Hohe Energieeffizienz  
Haute efficacité énergétique*



## Saldatura laser

*Laser welding Laserschweißen  
Soudage laser*



## Usò versatile

*Versatile placing Vielseitig Platzierung  
Utilisation polyvalente*



## Portasalviette

*Towel holder Handtuchhalter  
Porte-serviettes*



## Facile da installare

*Easy to install Einfach zu installieren  
Facile à installer*



## Facile da pulire

*Easy to clean Einfach zu säubern  
Facile à nettoyer*





# Caligo

## Termoarredo elettrico a muro

Electric radiator / Radiateur électrique / Elektrischer Heizkörper

75041.nn



**Acciaio al carbonio**  
Carbon steel  
Acier au carbone  
Karbonstahl



.09

.17

.18

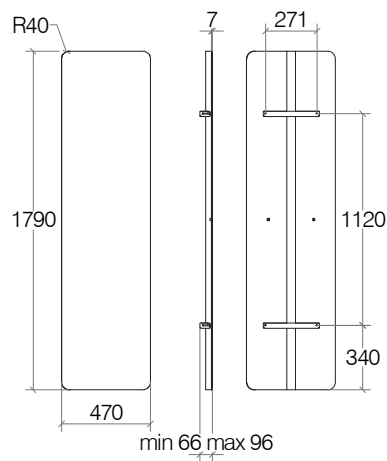

Con copertura staffe inclusa nell'imballo  
With bracket cover included in the package  
Avec chaches fixations inclus dans l'emballage  
Mit im Paket enthaltener Abdeckung

Resa Termica / Thermal Efficiency		Peso	
resistenza / resistance 5211, 5212		Weight	
Watt		kg	
max 800		26,5	
Assi Idraulici da centro a centro	Assi montaggio orizzontali	Assi montaggio verticali	Da inizio montaggio a fine prodotto
Hydraulic axes center to center	Horizontal mounting axes	Vertical mounting axes	From mounting start to product end
mm	mm	mm	mm
-	270	1120	1450

€ 717,00 - M

**Termoarredo elettrico a muro**

Electric radiator / Radiateur électrique / Elektrischer Heizkörper

**75051.nn**



**Acciaio al carbonio**  
Carbon steel  
Acier au carbone  
Karbonstahl



.09

.17

.18

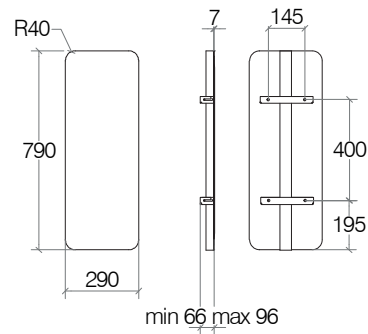

Con copertura staffe inclusa nell'imballo  
With bracket cover included in the package  
Avec chaches fixations inclus dans l'emballage  
Mit im Paket enthaltener Abdeckung

Resa Termica / Thermal Efficiency		Peso	
resistenza / resistance 5213 Watt max 200		Weight kg 11,7	
Assi Idraulici da centro a centro	Assi montaggio orizzontali	Assi montaggio verticali	Da inizio montaggio a fine prodotto
Hydraulic axes center to center	Horizontal mounting axes	Vertical mounting axes	From mounting start to product end
mm	mm	mm	mm
-	145	400	595

€ 439,00 - M

# Caligo

## Termoarredo idraulico a muro

Hydraulic radiator / Radiateur hydraulique / Hydraulischer Heizkörper

75011.nn



### Acciaio al carbonio

Carbon steel  
Acier au carbone  
Karbonstahl



.09



.17



.18

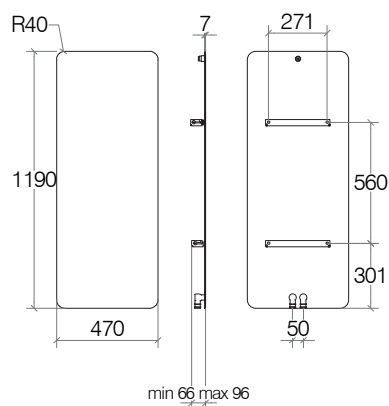

Con copertura staffe inclusa nell'imballo  
With bracket cover included in the package  
Avec chaches fixations inclus dans l'emballage  
Mit im Paket enthaltener Abdeckung

Resa Termica / Thermal Efficiency				Esponente	Volume acqua	Peso
$\Delta T = 50K$	$\Delta T = 60K$	70/55/24	55/45/24	Exponent	Water volume	Weight
(EN 442)						
Watt	Watt	Watt	Watt	n	dm <sup>3</sup>	kg
523	662	373	225	1,2907	1,1	17,5
Assi Idraulici da centro a centro		Assi montaggio orizzontali		Assi montaggio verticali	Da inizio montaggio a fine prodotto	
Hydraulic axes center to center		Horizontal mounting axes		Vertical mounting axes	From mounting start to product end	
mm		mm		mm	mm	
50 (looking up)		270		560	860	

€ 464,00 - M

**Termoarredo idraulico a muro**

**75021.nn**

Hydraulic radiator / Radiateur hydraulique / Hydraulischer Heizkörper



**Acciaio al carbonio**

Carbon steel  
Acier au carbone  
Karbonstahl

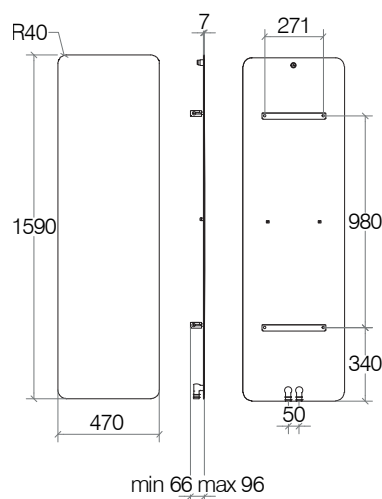
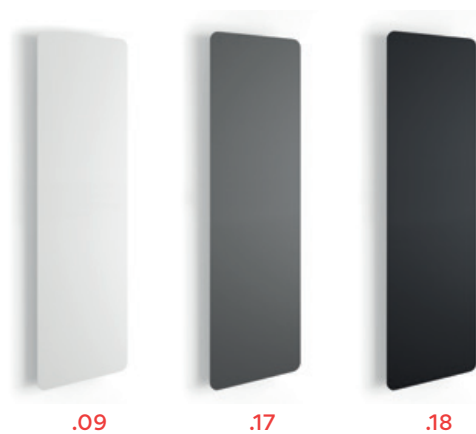

Con copertura staffe inclusa nell'imballo  
With bracket cover included in the package  
Avec chaches fixations inclus dans l'emballage  
Mit im Paket enthaltener Abdeckung

Resa Termica / Thermal Efficiency				Esponente	Volume acqua	Peso
$\Delta T = 50K$	$\Delta T = 60K$	70/55/24	55/45/24	Exponent	Water volume	Weight
(EN 442)						
Watt	Watt	Watt	Watt	n	dm3	kg
700	886	500	302	1,2907	1,5	23

Assi Idraulici da centro a centro	Assi montaggio orizzontali	Assi montaggio verticali	Da inizio montaggio a fine prodotto
Hydraulic axes center to center	Horizontal mounting axes	Vertical mounting axes	From mounting start to product end
mm	mm	mm	mm
50 (looking up)	270	980	1320

€ 618,00 - M

# Caligo

## Termoarredo idraulico a muro

75031.nn

Hydraulic radiator / Radiateur hydraulique / Hydraulischer Heizkörper



### Acciaio al carbonio

Carbon steel  
Acier au carbone  
Karbonstahl



.09

.17

.18

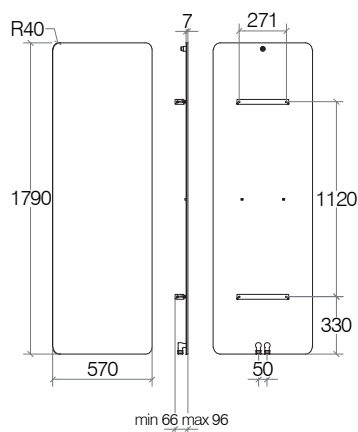

Con copertura staffe inclusa nell'imballo  
With bracket cover included in the package  
Avec chaches fixations inclus dans l'emballage  
Mit im Paket enthaltener Abdeckung

Resa Termica / Thermal Efficiency				Esponente	Volume acqua	Peso
$\Delta T = 50K$	$\Delta T = 60K$	70/55/24	55/45/24	Exponent	Water volume	Weight
(EN 442)						
Watt	Watt	Watt	Watt	n	dm <sup>3</sup>	kg
960	1214	685	413	1,2882	2	31
Assi Idraulici da centro a centro		Assi montaggio orizzontali		Assi montaggio verticali	Da inizio montaggio a fine prodotto	
Hydraulic axes center to center		Horizontal mounting axes		Vertical mounting axes	From mounting start to product end	
mm		mm		mm	mm	
50 (looking up)		270		1120	1450	

€ 710,00 - M



**Portasalvietta per termoarredo 470 mm**

**7509.nn**

Towel bar for radiator 470 mm / Barre porte-serviettes pour radiateur 470 mm / Handtuchhalter für Heizkörper 470 mm

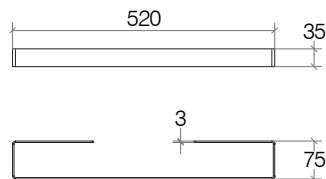

**Acciaio inox verniciato**  
Painted stainless steel  
Acier inoxydable verni  
Lackiertem Edelstahl

**Acciaio inox cromato**  
Chromed stainless steel  
Acier inoxydable chromé  
Verchromtes Edelstahl

**Acciaio inox spazzolato**  
Brushed stainless steel  
Acier inoxydable brossé  
Gebürsteter Edelstahl



.09



.17



.18



.29



.32

€ 44,00

**Portasalvietta per termoarredo ad acqua 470 mm**

**75092.nn**

Towel bar for water radiator 470 mm / Barre porte-serviettes pour radiateur eau chaude 470 mm / Handtuchhalter für Heizkörper 470 mm

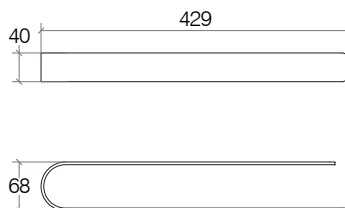

**Acciaio inox verniciato**  
Painted stainless steel  
Acier inoxydable verni  
Lackiertem Edelstahl

**Acciaio inox cromato**  
Chromed stainless steel  
Acier inoxydable chromé  
Verchromtes Edelstahl

**Acciaio inox spazzolato**  
Brushed stainless steel  
Acier inoxydable brossé  
Gebürsteter Edelstahl



.09



.17



.18



.29



.32

€ 44,00

**Portasalvietta per termoarredo ad acqua 570 mm**

**75093.nn**

Towel bar for water radiator 570 mm / Barre porte-serviettes pour radiateur eau chaude 570 mm / Handtuchhalter für Heizkörper 570 mm

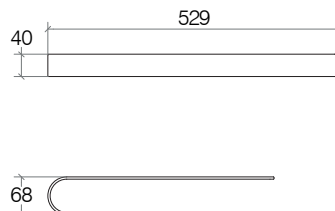

**Acciaio inox verniciato**  
Painted stainless steel  
Acier inoxydable verni  
Lackiertem Edelstahl

**Acciaio inox cromato**  
Chromed stainless steel  
Acier inoxydable chromé  
Verchromtes Edelstahl

**Acciaio inox spazzolato**  
Brushed stainless steel  
Acier inoxydable brossé  
Gebürsteter Edelstahl



.09



.17



.18



.29



.32

€ 50,00

## Caligo

### Resistenza elettrica on / off, 800 W - 230 V

On/off electrical resistance / Résistance électrique on/off / Elektrischer Widerstand on/off

7511.09

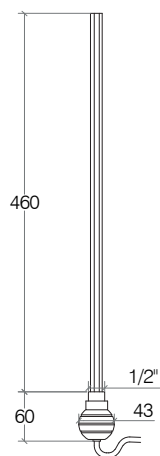

ABS  
ABS  
ABS  
ABS



.09

€ 110,00



### Resistenza elettrica con timer e regolazione temperatura, 800 W - 230 V

Heating element for electrical radiators with timer and temperature control

Résistance électrique avec timer et régulateur de température

Elektrischer Widerstand mit Timer und Temperaturregelung

7512.09

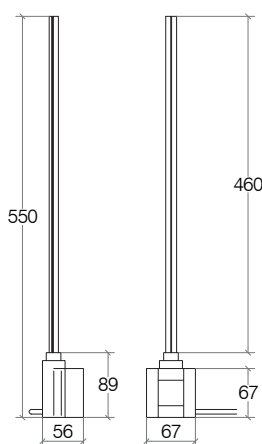

ABS  
ABS  
ABS  
ABS



.29

€ 210,00



### Resistenza elettrica con timer e regolazione temperatura, 200 W - 230 V

Heating element for electrical radiators with timer and temperature control

Résistance électrique avec timer et régulateur de température

Elektrischer Widerstand mit Timer und Temperaturregelung

7513.09

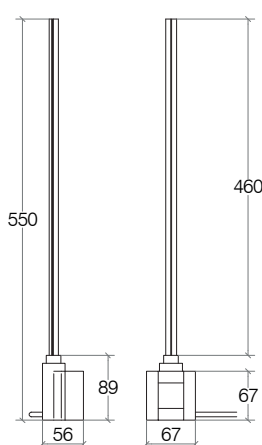

ABS  
ABS  
ABS  
ABS



.29

€ 210,00



**Gruppo valvola e detentore 50 mm - destro**

Thermostatic lockshield valve 50 mm - right / Groupe vanne et détendeur, 50 mm, droit / Ventile Detentoren 50 mm rechts

**7510.29**

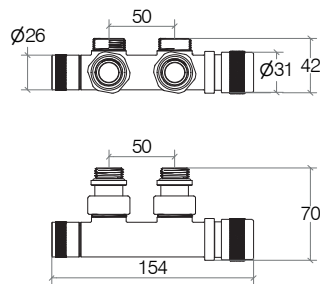

**Ottone cromato**  
Chromed brass  
Laiton chromé  
Verchromtes Messing



.29



€ 122,00

**Testa termostatica per gruppo valvola**

Thermostatic head for valve group / Vanne thermostatique / Ventile Thermostatisch

**7515.29**

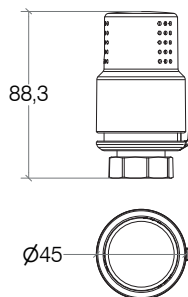

**ABS cromato**  
Chromed ABS  
ABS chromé  
Verchromtes ABS



.29



€ 61,00

**Kit copritubo 50 mm**

Tube cover kit 50 mm / Kit cache-tuyau 50 mm / Rohrabdeckungs-Set 50 mm

**7516.29**

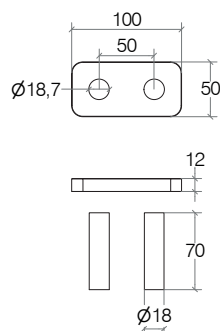

**Ottone cromato**  
Chromed brass  
Laiton chromé  
Verchromtes Messing



.29



€ 50,00

## Caligo

### Kit raccordi per tubo rame e multistrato

Copper and multilayer collar kit / Kit raccords pour tuyaux / Anschlussstück aus Kupfer

7517.29



**Ottone cromato**  
Chromed brass  
Laiton chromé  
Verchromtes Messing



.29

€ 33,00

### Appendino per termoarredo e box doccia

Hook for radiator and shower box / Patère pour radiateur et paroi de douche / Haken für Heizkörper und Duschkabine

52964.nn

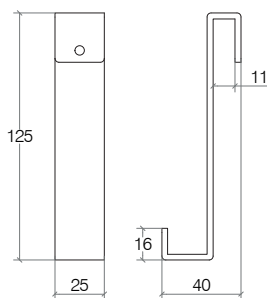

**Acciaio inox lucido**  
Polished stainless steel  
Acier inoxydable brillant  
Poliert Edelstahl



.29

**Acciaio inox satinato**  
Satinated stainless steel  
Acier inoxydable satiné  
Vereist Edelstahl



.32

€ 29,00 - S

### Appendini per termoarredo e box doccia (12 pezzi)

Hooks for radiators and shower enclosure (12 pieces)

Patère pour radiateur et paroi de douche (12 pièces)

Haken für Heizkörper und Duschkabinen (12 Stk)

50038.09

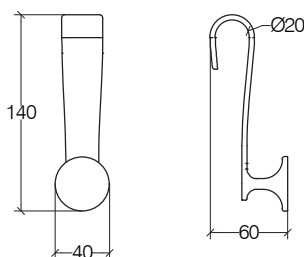

**ABS bianco**  
White ABS  
ABS blanc  
Weiß ABS



.09

€ 44,00 - S

## Ricambi / Spare parts / Pièces détachées / Ersatzteile

<b>75011</b>	R247501109	Kit copertura staffe bianche 1190x470 - White bracket cover kit 1190x470	<b>99,00</b>
	R247501117	Kit copertura staffe grigio 1190x470 - Grey bracket cover kit 1190x470	<b>99,00</b>
	R247501118	Kit copertura staffe nero 1190x470 - Black bracket cover kit 1190x470	<b>99,00</b>
<b>75021</b>	R247502109	Kit copertura staffe bianco 1590X470 - White bracket cover kit 1590X470	<b>99,00</b>
	R247502117	Kit copertura staffe grigio 1590X470 - Grey bracket cover kit 1590X470	<b>99,00</b>
	R247502118	Kit copertura staffe nero 1590X470 - Black bracket cover kit 1590X470	<b>99,00</b>
<b>75031</b>	R247503109	Kit copertura staffe bianco 1790X570 - White bracket cover kit 1790X570	<b>108,00</b>
	R247503117	Kit copertura staffe grigio 1790X570 - Grey bracket cover kit 1790X570	<b>108,00</b>
	R247503118	Kit copertura staffe nero 1790X570 - Black bracket cover kit 1790X570	<b>108,00</b>



# complementi

*Complements / Compléments / Ergänzungen*

## **Cestini / 326**

*Paper baskets / Corbeilles à papier / Papierkorb*

## **Portabiancheria / 330**

*Laundry baskets / Paniers à linge / Wäschekorb*

## **Sgabelli / 334**

*Stools / Tabourets / Hocker*

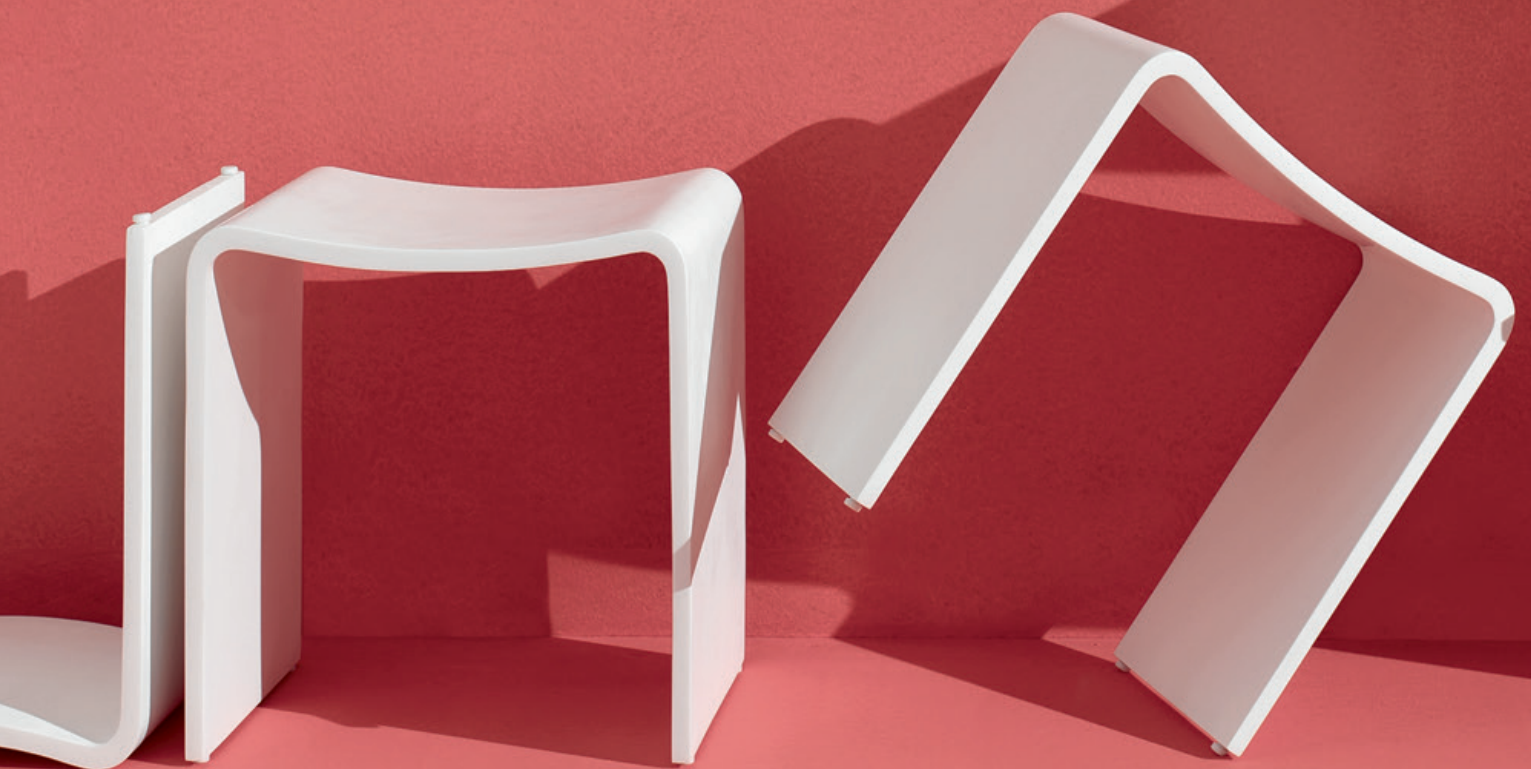



## Bandoni

### Porta fazzoletti

Tissue holder / Distributeur de mouchoirs / Papierhandtuchspender

53441.nn

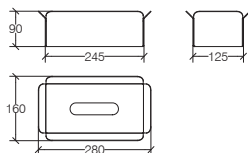

**Alluminio verniciato**  
Painted aluminium  
Aluminium laqué  
Lackiertem Aluminium



.09



.17



.18



€ 73,00 - S

### Gettacarta

Paper basket / Poubelle à papier / Papierkorb

53442.nn

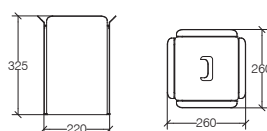

**Alluminio verniciato**  
Painted aluminium  
Aluminium laqué  
Lackiertem Aluminium



.09



.17



.18



€ 114,00 - M

### Portabiancheria con sacco in cotone

Laundry basket with cotton bag / Panier à linge avec sac en coton / Wäschekorb mit Baumwolle Sack

53443.nn

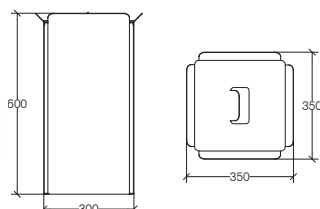

**Alluminio verniciato**  
Painted aluminium  
Aluminium laqué  
Lackiertem Aluminium



.09



.17



.18



€ 209,00 - L



**Pattumiera con secchiello 3 lt**

Dustbin with bucket / Poubelle avec seau / Abfalleimer mit Eimer

**5344.29**

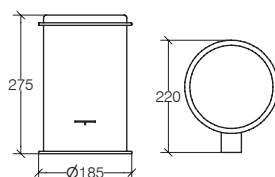

**Acciaio inox lucido**  
Polished stainless steel  
Acier inoxydable brillant  
Poliert Edelstahl



.29



€ 106,00 - M

**Pattumiera con secchiello 5 lt**

Dustbin with bucket / Poubelle avec seau / Abfalleimer mit Eimer

**5347.29**

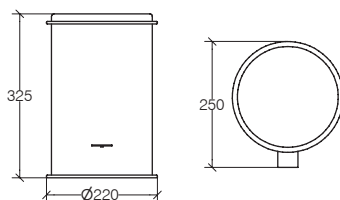

**Acciaio inox lucido**  
Polished stainless steel  
Acier inoxydable brillant  
Poliert Edelstahl



.29



€ 114,00 - M

**Pattumiera con secchiello 3 lt**

Dustbin with bucket / Poubelle avec seau / Abfalleimer mit Eimer

**53297.29**

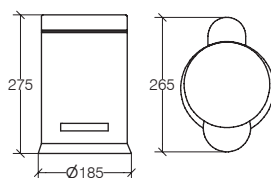

**Acciaio inox lucido**  
Polished stainless steel  
Acier inoxydable brillant  
Poliert Edelstahl



.29

€ 64,00 - S



## Sestei

### Pattumiera con secchiello 5 lt

Dustbin with bucket / Poubelle avec seau / Abfalleimer mit Eimer

53298.29

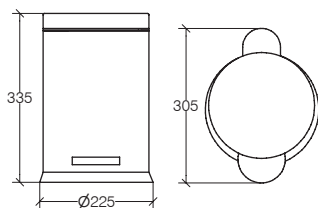

**Acciaio inox lucido**  
Polished stainless steel  
Acier inoxydable brillant  
Poliert Edelstahl



.29

€ 84,00 - S

### Gettacarta

Paper basket / Corbeille à papier / Papierkorb

5345.nn

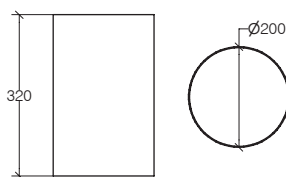

**Acciaio inox lucido**  
Polished stainless steel  
Acier inoxydable brillant  
Poliert Edelstahl

**Acciaio inox verniciato**  
Painted stainless steel  
Acier inoxydable laqué  
Lackiertem Edelstahl



.29

€ 73,00 - S



.22

€ 82,00 - S

### Gettacarta

Paper basket / Corbeille à papier / Papierkorb

5348.29

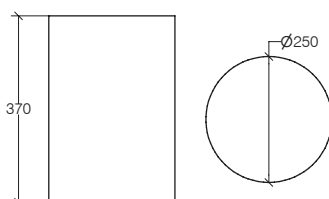

**Acciaio inox lucido**  
Polished stainless steel  
Acier inoxydable brillant  
Poliert Edelstahl



.29

€ 93,00 - S

ITALY

**Pattumiera con secchiello 3 lt**

Dustbin with bucket / Poubelle avec seau / Abfalleimer mit Eimer

**5354.29**

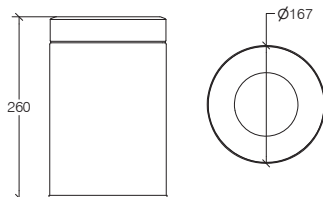

**Acciaio inox lucido**  
Polished stainless steel  
Acier inoxydable brillant  
Poliert Edelstahl



.29

€ 42,00 - S

**Pattumiera con secchiello 5 lt**

Dustbin with bucket / Poubelle avec seau / Abfalleimer mit Eimer

**5355.29**

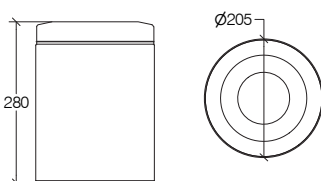

**Acciaio inox lucido**  
Polished stainless steel  
Acier inoxydable brillant  
Poliert Edelstahl

**Acciaio inox verniciato**  
Painted stainless steel  
Acier inoxydable laqué  
Lackiertem Edelstahl



.29

€ 46,00 - S



.22

€ 60,00 - S

**Gettacarta forato**

Perforated paper basket / Corbeille à papier percée / Papierkorb gelocht

**5346.29**

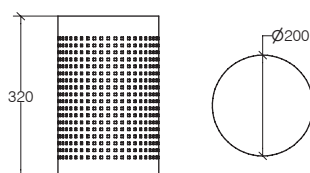
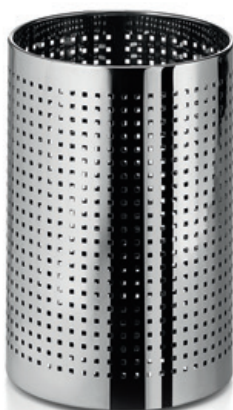

**Acciaio inox lucido**  
Polished stainless steel  
Acier inoxydable brillant  
Poliert Edelstahl



.29

€ 77,00 - S



## Sestei

### Gettacarta forato

Perforated paper basket / Corbeille à papier percée / Papierkorb gelocht

5349.29

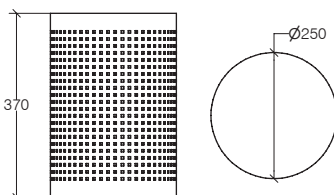
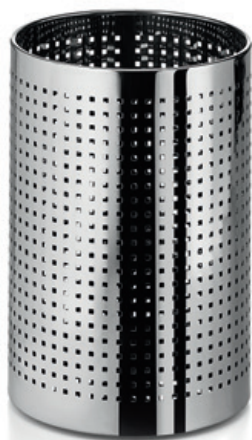

Acciaio inox lucido  
Polished stainless steel  
Acier inoxydable brillant  
Poliert Edelstahl



.29



€ 100,00 - M

### Gettacarta forato con coperchio

Perforated paper basket with lid / Corbeille à papier percée avec couvercle / Papierkorb gelocht mit Deckel

5350.29.29

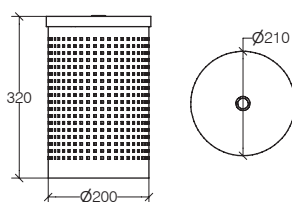

Acciaio inox lucido  
Polished stainless steel  
Acier inoxydable brillant  
Poliert Edelstahl



.29



€ 106,00 - M

### Portabiancheria forato con coperchio

Perforated laundry basket with lid / Panier à linge percée avec couvercle / Wäschekorb gelocht mit Deckel

5351.29.29

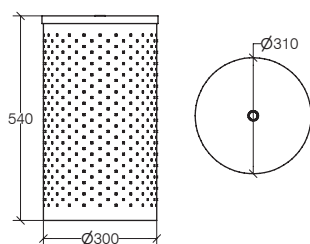

Acciaio inox lucido  
Polished stainless steel  
Acier inoxydable brillant  
Poliert Edelstahl



.29



€ 163,00 - M

**Portabiancheria forato con coperchio**

Perforated laundry basket with lid / Panier à linge percée avec couvercle / Wäschekorb gelocht mit Deckel

**5352.29.29**

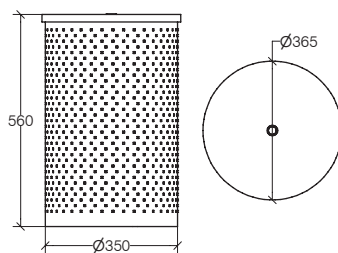

**Acciaio inox lucido**  
Polished stainless steel  
Acier inoxydable brillant  
Poliert Edelstahl



.29

€ 197,00 - M



**Pattumiera con apertura elettrica sensibile al movimento 9 lt**

Dustbin with electric motion sensor opener / Poubelle avec ouverture électrique / Elektronischer Sensor Abfalleimer

**5356.32**

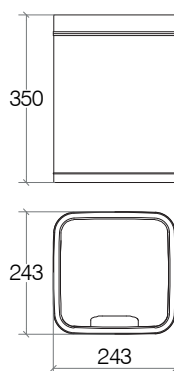

**Acciaio inox satinato**  
Satinated stainless steel  
Acier inoxydable satiné  
Vereist Edelstahl



.32

€ 121,00 - M

**Pattumiera rettangolare**

Rectangular dustbin / Poubelle rectangulaire / Rechteckig Abfalleimer

**5357.32**

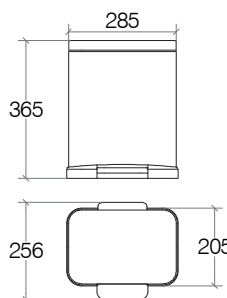

**Acciaio inox satinato**  
Satinated stainless steel  
Acier inoxydable satiné  
Vereist Edelstahl



.32

€ 110,00 - M

## Sestei

### Pattumiera con coperchio basculante

Dustbin with tilting lid / Poubelle avec couvercle à bascule / Abfalleimer mit Kippdeckel

5358.22

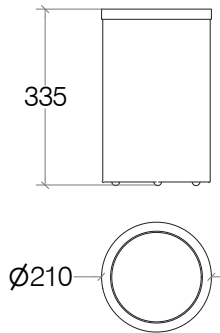

Acciaio inox verniciato  
Painted stainless steel  
Acier inoxydable laqué  
Lackiertem Edelstahl



.22



€ 194,00 - M

### Bidoncino da tavolo quadrato

Square table paper bin / Petite corbeille de table carrée / Tischabfallbehälter quadratisch

44020.nn

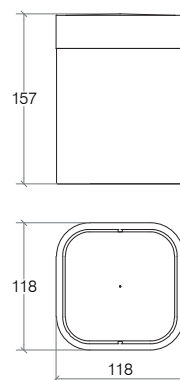

Acciaio inox lucido  
Polished stainless steel  
Acier inox brillant  
Glänzer Edelstahl



.29

€ 54,00 - M

**Bidoncino da tavolo tondo**

Round table paper bin / Petite corbeille de table ronde / Tischabfallbehälter rund

**44019.nn**

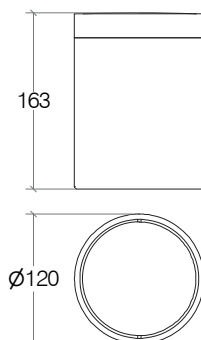

**Acciaio inox lucido**  
*Polished stainless steel*  
*Acier inox brillant*  
*Glänzer Edelstahl*



**.29**

€ 54,00 - S

**Bidoncino da tavolo tondo**

Round table paper bin / Petite corbeille de table ronde / Tischabfallbehälter rund

**5359.22**

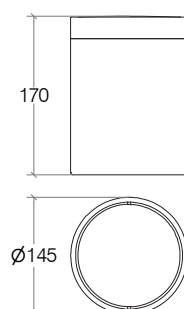

**Acciaio verniciato**  
*Painted steel*  
*Acier laqué*  
*Lackiertem Stahl*



**.22**



€ 111,00 - M

**Scagni**

**Piano sgabello Grela**

Tray for stool / Plateau pour tabouret / Tablett für Hocker

**8292.nn**

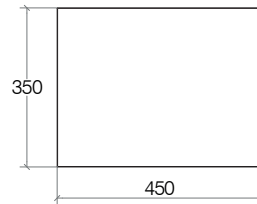

**Laccato lucido**  
Glossy lacquered  
Laqué brillant  
Glänzend Lackiert



.09L



.17L



.21L



.22L

€ 153,00

**Laccato opaco**  
Mat lacquered  
Laqué mat  
Matt Lackiert



.09



.17



.21



.22

€ 135,00

**Laminato**  
Laminated  
Stratifié  
Holzlaminat



.03



.01



.02



.05

€ 80,00

**Struttura sgabello Grela**

Frame for stool / Structure pour tabouret / Gestell für Hocker

**82921.nn**

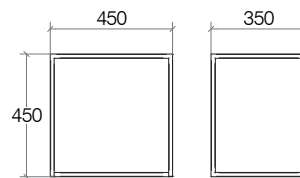
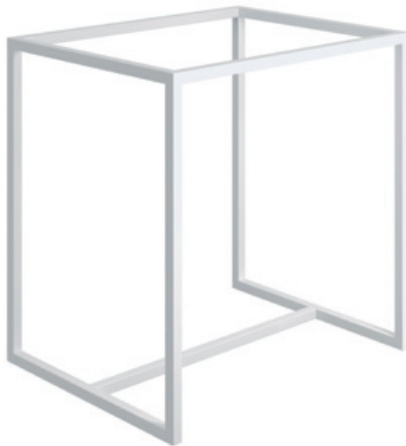

**Acciaio verniciato**  
Painted steel  
Acier laqué  
Lackiertem Stahl



.09



.18

€ 184,00 - L

**Acciaio inox lucido**  
Polished stainless steel  
Acier inoxydable brillant  
Poliert Edelstahl



.29

€ 369,00 - L

**Acciaio inox nickel nero**  
Black nickel stainless steel  
Acier inoxydable nickel  
Edelstahl Nickel Schwarz



.33

€ 540,00 - L



**Sgabello**

Stool / Tabouret / Hocker

**81119.03**

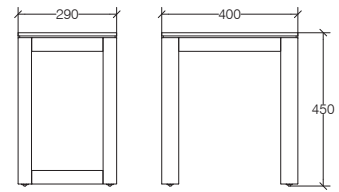

**Bambù verniciato**  
*Vernished Bamboo*  
*Bambou verni*  
*Zinnobambus*



**.03**

€ 221,00 - M

**Panca**

Bench / Banc / Bank

**81120.03**

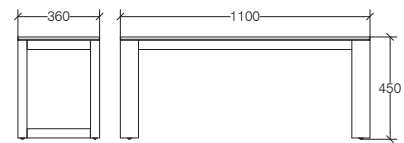

**Bambù verniciato**  
*Vernished Bamboo*  
*Bambou verni*  
*Zinnobambus*



**.03**

€ 386,00 - L

## Scagni

### Sgabello

Stool / Tabouret / Hocker

54702.26

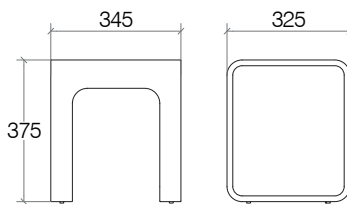

Portata max 150 Kg  
Max weight 150 Kg  
Poids maximal 150 Kg  
Max gewicht 150 Kg

Mattstone  
Mattstone  
Mattstone  
Mattstone



.26

€ 275,00 - M

### Sgabello

Stool / Tabouret / Hocker

54703.26

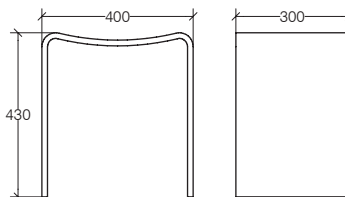

Portata max 150 Kg  
Max weight 150 Kg  
Poids maximal 150 Kg  
Max gewicht 150 Kg

Mattstone  
Mattstone  
Mattstone  
Mattstone



.26

€ 275,00 - M

### Sedile doccia in teak

Teak shower seat / Siège de douche en teak / Duschsitz aus Teak

54720.29

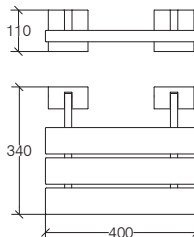

Portata max 130 Kg  
Max weight 130 Kg  
Poids maximal 130 Kg  
Max gewicht 130 Kg

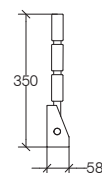

Acciaio inox - Teak  
Stainless steel - teak wood  
Acier inoxydable - Teak  
Edelstahl - Teak



.29

€ 198,00 - M

*Complementi / Complements / Compléments / Ergänzungen*

**Ricambi / Spare parts / Pièces détachées / Ersatzteile**

<b>53442</b>	R2253442	Chiodino silicone blocca sacchetto - Silicon stud bag blocks	<b>3,00</b>
<b>53443</b>	R3053443	Sacco in tessuto bianco per art. 53443 - White fabric bag for art.53443	<b>46,00</b>
<b>5350</b>	R2353503	Coperchio Ø 200 mm - Lid Ø 200 mm	<b>29,00</b>
<b>5351</b>	R2353513	Coperchio Ø 300 mm - Lid Ø 300 mm	<b>41,00</b>
<b>5352</b>	R2353523	Coperchio Ø 350 mm - Lid Ø 350 mm	<b>46,00</b>
<b>54720</b>	R2254720	Copertura ABS e attacco a muro - Wall ABS cover and fix kit	<b>5,00</b>



# doccia

*shower / douche / Dusche*

## **Doccia da esterni / 340**

*Outdoor shower / Douche pour usage externe / Aussendusche beweglich*

## **Soffioni bracci doccia / 344**

*Shower heads and shower-arms / Pommés de douche et bras de douche / Kopfbrause und Brausearm*

## **Colonne doccia e doccette / 358**

*Shower columns and hand shower / Colonne de douche et douchettes / Duschsäulen und Handbrause*

## **Griglie e accessori doccia / 366**

*Shower baskets and shower accessories / Paniers et accessoires douche / Duschkörbe und Duschzubehöre*

## **Pedane doccia / 374**

*Shower mats / Caillebotis / Duschfußbrett*





## Doccia da esterni

Outdoor shower / Douche pour usage externe / Aussendusche beweglich

### IT

**Istà:**  
estate.

Doccia da esterni mobile, che come l'estate viene riposta per poi ritornare. Estremamente leggera, perfetta per ambienti outdoor stagionali.

Designer: Studio JoeVelluto

Polietilene e acciaio inox verniciato

### EN

**Istà:**  
summer.

*Extremely light outdoor shower, perfect for seasonal outdoor environments. The versatility of this product makes it suitable for various types of spaces and needs: it can be connected directly to the garden hose for a freer and less stationary use as well as to a traditional plumbing system.*

Designer: Studio JoeVelluto

*Polyethylene and painted stainless steel*

### FR

**Istà :**  
l'Été.

*Douche mobile d'extérieur, qui comme l'Été s'en va pour mieux revenir. Extrêmement légère, elle est parfaite pour les espaces outdoor saisonniers.*

Concepteur : Studio JoeVelluto

*Polyéthylène et acier inox verni*

### DE

**Istà:**  
Sommer.

*Mobile Dusche für den Außenbereich, äußerst leicht und ideal für saisonal genutzte Außenbereiche.*

*Mit seiner Vielseitigkeit ist dieses Produkt für verschiedene Arten von Bereichen und Anforderungen geeignet: die Dusche kann für einen freien und mobilen Gebrauch direkt an den Gartenschlauch oder aber an eine traditionelle Wasserversorgung angeschlossen werden.*

Designer: Studio JoeVelluto

*Polyäthylen und lackierter Edelstahl*



Istà

---





53830.09.20

**Doccia da esterni mobile con base in polietilene, staffa e soffione in metallo verniciato a polveri**

Outdoor movable shower. Polyethylene base, dust painted metal tubular and shower head

Douche mobile pour usage externe, base en polyéthylène, colonne et pomme de douche en acier verni à poudre

Aussendusche beweglich mit Fuß aus Polyäthylen, Kolumn und Duschkopf aus lackiertem Edelstahl

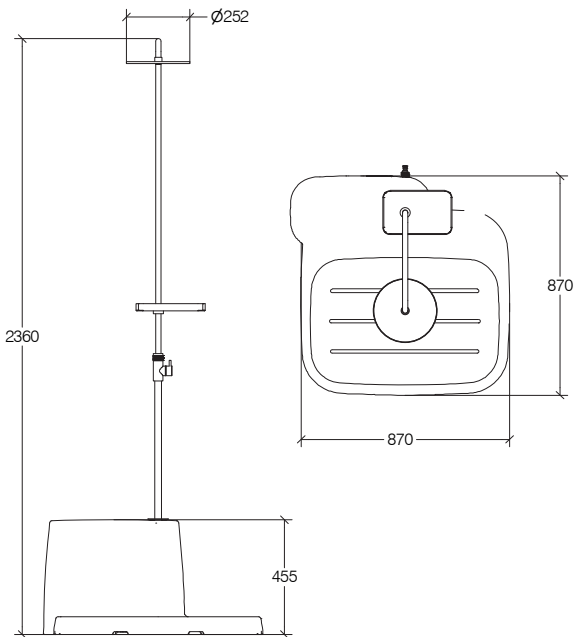

ITALY

€ 1025,00 - L



## Soffioni e bracci doccia

Shower heads and shower-arms / Pommés de douche et bras de douche / Kopfbrause und Brausearm

### IT

#### Supioni:

nel gergo, quei palloncini leggeri che invadono le campagne al termine della fioritura dei tarassachi.

Avvolgenti getti di benessere dalla collezione di soffioni doccia, disponibili in diverse dimensioni e forme per esclusivi momenti di relax.

Acciaio inox o ottone cromato

### EN

#### Supioni:

*in slang, those light balloons that invade the countryside at the end of the flowering stage of dandelions.*

*Enveloping jets of wellness from the collection of shower heads, available in different sizes and shapes for those exclusive moments of relaxation.*

*Stainless steel or chromed brass*

### FR

#### Supioni :

*en argot, ce sont les duvets légers qui envahissent la campagne en fin de floraison des pissenlits.*

*Une collection de pommeaux de douche aux jets enveloppants de bien-être, disponibles en différentes tailles et formes pour des moments exclusifs de détente.*

*Acier inox ou laiton chromé*

### DE

#### Supioni:

*im Jargon jene leichten Bällchen, die das Land am Ende der Löwenzahnblüte überziehen.*

*Hüllende Strahlen des Wohlbefindens gehen von den Duschköpfen dieser Kollektion aus, die in verschiedenen Größen und Formen für exklusive Augenblicke der Entspannung sorgen.*

*Edelstahl oder verchromtes Messing*



## Supioni

### Colonna doccia completa con miscelatore e doccetta

Shower column complete with mixer and handshower  
 Colonne de douche avec mitigeur et douchette  
 Duschsäule mit Mischer und Handbrause

**53915.nn**

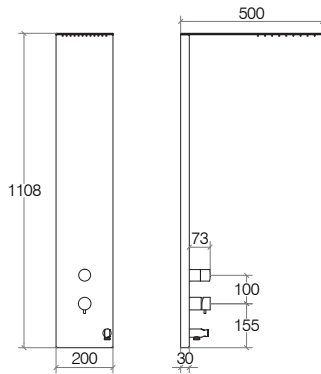

**Acciaio inox lucido**  
 Polished stainless steel  
 Acier inoxydable brillant  
 Poliert Edelstahl

**Acciaio inox satinato**  
 Satined stainless steel  
 Acier inoxydable satiné  
 Vereist Edelstahl



**.29**

€ 629,00 - L



**.32**

€ 728,00 - L



### Colonna doccia completa con miscelatore termostatico e doccetta

Shower column with thermostatic mixer and handshower  
 Colonne de douche avec mitigeur thermostatique et douchette  
 Duschsäule mit Thermostat-Mischer und Handbrause

**53917.nn**

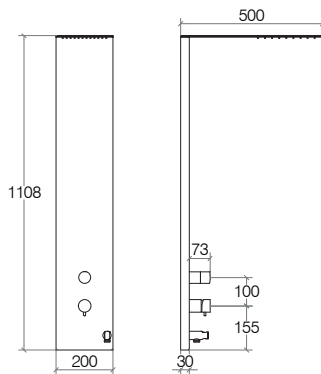

**Acciaio inox lucido**  
 Polished stainless steel  
 Acier inoxydable brillant  
 Poliert Edelstahl

**Acciaio inox satinato**  
 Satined stainless steel  
 Acier inoxydable satiné  
 Vereist Edelstahl



**.29**

€ 1156,00 - L



**.32**

€ 1395,00 - L



**Soffione a soffitto tondo Ø 400 mm solo pioggia**

Built-In round Ø 400 mm shower head, rain  
 Pomme de douche de plafond ronde Ø 400 mm pluie  
 Kopfbrause runde am Decken Ø 400 mm nur Regen

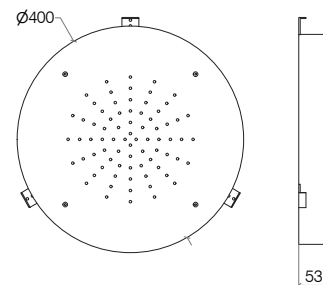
**53862.nn**

**Acciaio inox lucido**  
 Polished stainless steel  
 Acier inoxydable brillant  
 Poliert Edelstahl

**Acciaio inox satinato**  
 Satined stainless steel  
 Acier inoxydable satiné  
 Vereist Edelstahl

**.29**

€ 540,00 - L

**.32**

€ 529,00 - L

**Soffione a soffitto quadro 430 x 430 mm solo pioggia**

Built-in square 430 x 430 mm shower head, rain  
 Pomme de douche de plafond carrée 430 x 430 mm pluie  
 Kopfbrause quadratisch am Decken 430 x 430 mm nur Regen

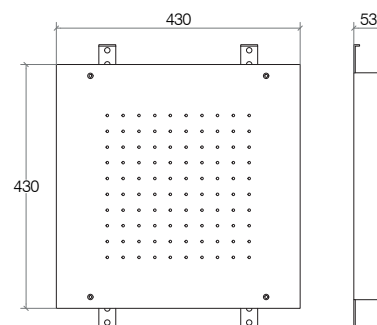
**53864.nn**

**Acciaio inox lucido**  
 Polished stainless steel  
 Acier inoxydable brillant  
 Poliert Edelstahl

**Acciaio inox satinato**  
 Satined stainless steel  
 Acier inoxydable satiné  
 Vereist Edelstahl

**.29**

€ 794,00 - L

**.32**

€ 783,00 - L



## Supioni

### Soffione doccia ispezionabile con snodo 1/2"

Self-cleaning shower head, with 1/2" connection  
Pomme de douche autonettoyante avec raccord 1/2"  
Selbstreinigender Kopfbrause mit Kugelgelenk G 1/2"

**53810.29**

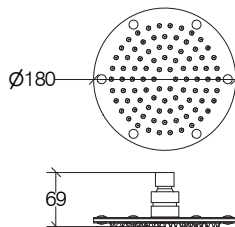

Ottone cromato  
Chromed brass  
Laiton chromé  
Verchromtes Messing



€ 86,00 - S

### Soffione doccia ispezionabile con snodo 1/2"

Self-cleaning shower head, with 1/2" connection  
Pomme de douche autonettoyante avec raccord 1/2"  
Selbstreinigender Kopfbrause mit Kugelgelenk G 1/2"

**53811.29**

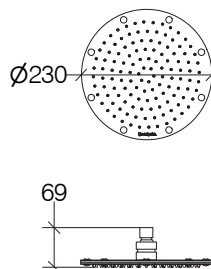

Ottone cromato  
Chromed brass  
Laiton chromé  
Verchromtes Messing

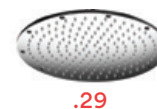

€ 150,00 - S

### Soffione doccia ispezionabile con snodo 1/2"

Self-cleaning shower head, with 1/2" connection  
Pomme de douche autonettoyante avec raccord 1/2"  
Selbstreinigender Kopfbrause mit Kugelgelenk G 1/2"

**53812.29**

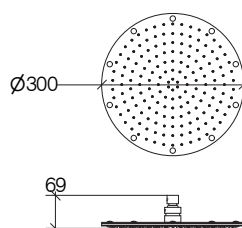

Ottone cromato  
Chromed brass  
Laiton chromé  
Verchromtes Messing



€ 225,00 - S

## Supioni

**Soffione doccia ispezionabile con snodo ½"**

Self-cleaning shower head, with ½" connection  
 Pomme de douche autonettoyante avec raccord ½"  
 Selbstreinigender Kopfbrause mit Kugelgelenk G ½"

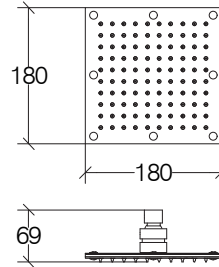
**53815.29**

**Ottone cromato**  
 Chromed brass  
 Laiton chromé  
 Verchromtes Messing

**.29**

€ 98,00 - S

**Soffione doccia ispezionabile con snodo ½"**

Self-cleaning shower head, with ½" connection  
 Pomme de douche autonettoyante avec raccord ½"  
 Selbstreinigender Kopfbrause mit Kugelgelenk G ½"

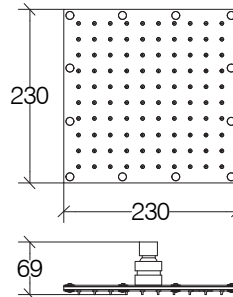
**53816.29**

**Ottone cromato**  
 Chromed brass  
 Laiton chromé  
 Verchromtes Messing

**.29**

€ 155,00 - S

**Soffione doccia ispezionabile con snodo ½"**

Self-cleaning shower head, with ½" connection  
 Pomme de douche autonettoyante avec raccord ½"  
 Selbstreinigender Kopfbrause mit Kugelgelenk G ½"

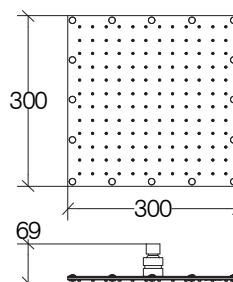
**53817.29**

**Ottone cromato**  
 Chromed brass  
 Laiton chromé  
 Verchromtes Messing

**.29**

€ 251,00 - S



## Supioni

### Soffione doccia tondo piatto con snodo 1/2"

Round flat shower head, with 1/2" connection  
Pomme de douche ronde plate avec raccord 1/2"  
Duschkopf flach rund mit Kugelgelenk G 1/2"

53840.29

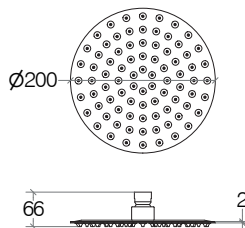
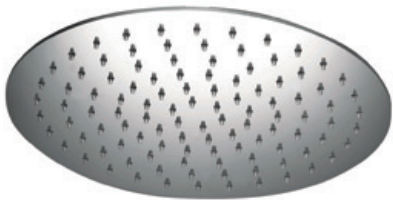

**Acciaio inox lucido**  
Polished stainless steel  
Acier inoxydable brillant  
Poliert Edelstahl



.29

AISI  
304

€ 88,00 - S

### Soffione doccia tondo piatto con snodo 1/2"

Round flat shower head, with 1/2" connection  
Pomme de douche ronde plate avec raccord 1/2"  
Duschkopf flach rund mit Kugelgelenk G 1/2"

53841.29

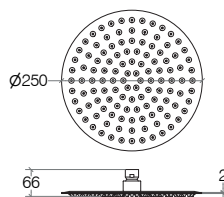

**Acciaio inox lucido**  
Polished stainless steel  
Acier inoxydable brillant  
Poliert Edelstahl



.29

AISI  
304

€ 122,00 - S

### Soffione doccia tondo piatto con snodo 1/2"

Round flat shower head, with 1/2" connection  
Pomme de douche ronde plate avec raccord 1/2"  
Duschkopf flach rund mit Kugelgelenk G 1/2"

53842.29

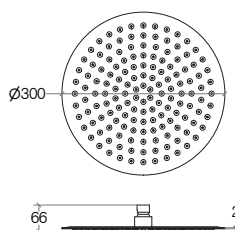

**Acciaio inox lucido**  
Polished stainless steel  
Acier inoxydable brillant  
Poliert Edelstahl



.29

AISI  
304

€ 133,00 - S



## Supioni

**Soffione doccia quadro piatto con snodo ½"**

Square flat shower head, with ½" connection  
 Pomme de douche carrée plate avec raccord ½"  
 Duschkopf flach quadratisch mit Kugelgelenk G ½"

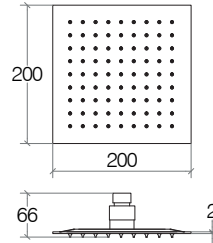
**53834.29**

**Acciaio inox lucido**  
 Polished stainless steel  
 Acier inoxydable brillant  
 Poliert Edelstahl

**.29**

AISI  
304

€ 94,00 - S

**Soffione doccia quadro piatto con snodo ½"**

Square flat shower head, with ½" connection  
 Pomme de douche carrée plate avec raccord ½"  
 Duschkopf flach quadratisch mit Kugelgelenk G ½"

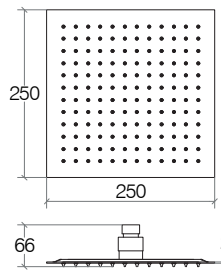
**53835.29**

**Acciaio inox lucido**  
 Polished stainless steel  
 Acier inoxydable brillant  
 Poliert Edelstahl

**.29**

AISI  
304

€ 127,00 - S

**Soffione doccia quadro piatto con snodo ½"**

Square flat shower head, with ½" connection  
 Pomme de douche carrée plate avec raccord ½"  
 Duschkopf flach quadratisch mit Kugelgelenk G ½"

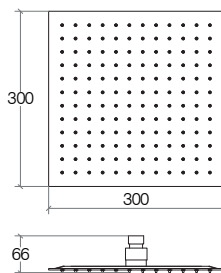
**53836.29**

**Acciaio inox lucido**  
 Polished stainless steel  
 Acier inoxydable brillant  
 Poliert Edelstahl

**.29**

AISI  
304

€ 138,00 - S



## Supioni

### Soffione doccia rettangolare piatto con snodo 1/2"

53839.29

Rectangular flat shower head, with 1/2" connection  
 Pomme de douche rectangulaire plate, avec raccord 1/2"  
 Duschkopf flach rechteckiger mit Kugelgelenk G 1/2"

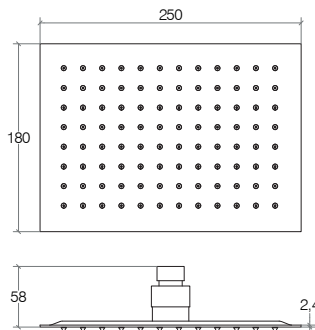

**Acciaio inox lucido**  
 Polished stainless steel  
 Acier inoxydable brillant  
 Poliert Edelstahl



.29

€ 116,00 - S

AISI  
304

### Soffione doccia rettangolare piatto con attacco 1/2"

53860.29

Rectangular flat shower head, with 1/2" connection  
 Pomme de douche rectangulaire plate avec doubles raccord 1/2"  
 Duschkopf flach rechteckiger mit Kugelgelenk G 1/2"

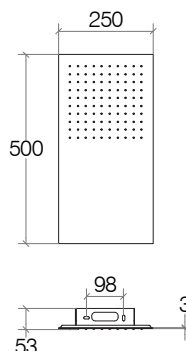

**Acciaio inox lucido**  
 Polished stainless steel  
 Acier inoxydable brillant  
 Poliert Edelstahl



.29

€ 315,00 - L

AISI  
304

### Soffione doccia rettangolare piatto con cascata con doppio attacco 1/2"

53861.29

Rectangular flat shower head with waterfall with double 1/2" connection  
 Pomme de douche rectangulaire plate en avec cascade avec raccord 1/2"  
 Duschkopf flach rechteckiger mit Wasserfallfunktion mit Kugelgelenk G 1/2" dopplet

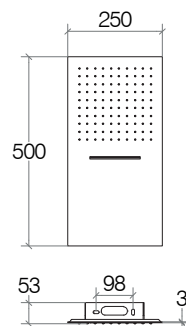

**Acciaio inox lucido**  
 Polished stainless steel  
 Acier inoxydable brillant  
 Poliert Edelstahl



.29

€ 315,00 - L

AISI  
304

## Supioni

**Soffione doccia tondo spessorato 7 mm con snodo ½"****53870.29**

Thickened round shower head 7 mm, with ½" connection  
 Pomme de douche ronde épaisseur 7 mm, avec raccord ½"  
 Duschkopf rund Dicke 7 mm mit Kugelgelenk G ½"

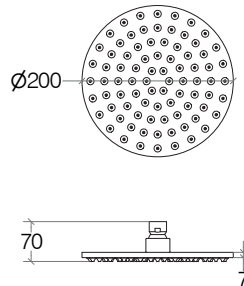

**Acciaio inox lucido**  
 Polished stainless steel  
 Acier inoxydable brillant  
 Poliert Edelstahl



.29

€ 88,00 - S

AISI  
304

**Soffione doccia tondo spessorato 7 mm con snodo ½"****53871.29**

Thickened round shower head 7 mm, with ½" connection  
 Pomme de douche ronde épaisseur 7 mm, avec raccord ½"  
 Duschkopf rund Dicke 7 mm mit Kugelgelenk G ½"

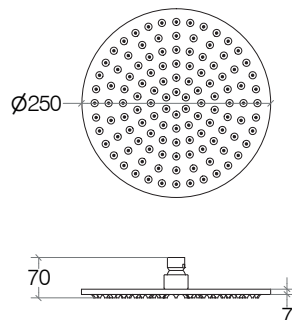

**Acciaio inox lucido**  
 Polished stainless steel  
 Acier inoxydable brillant  
 Poliert Edelstahl



.29

€ 122,00 - S

AISI  
304

**Soffione doccia tondo spessorato 7 mm con snodo ½"****53872.29**

Thickened round shower head 7 mm, with ½" connection  
 Pomme de douche ronde épaisseur 7 mm, avec raccord ½"  
 Duschkopf rund Dicke 7 mm mit Kugelgelenk G ½"

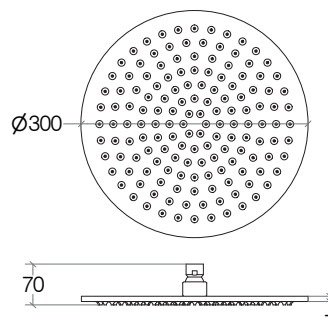

**Acciaio inox lucido**  
 Polished stainless steel  
 Acier inoxydable brillant  
 Poliert Edelstahl



.29

€ 133,00 - S

AISI  
304



## Supioni

### Soffione doccia quadro spessorato 7 mm con snodo 1/2"

53880.29

Thickened square shower head 7 mm, with 1/2" connection  
 Pomme de douche carrée épaisseur 7 mm, avec raccord 1/2"  
 Duschkopf quadratisch Dicke 7 mm mit Kugelgelenk G 1/2"

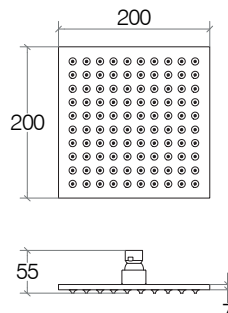

**Acciaio inox lucido**  
 Polished stainless steel  
 Acier inoxydable brillant  
 Poliert Edelstahl



.29

€ 94,00 - S

AISI  
304

### Soffione doccia quadro spessorato 7 mm con snodo 1/2"

53881.29

Thickened square shower head 7 mm, with 1/2" connection  
 Pomme de douche carrée épaisseur 7 mm, avec raccord 1/2"  
 Duschkopf quadratisch Dicke 7 mm mit Kugelgelenk G 1/2"

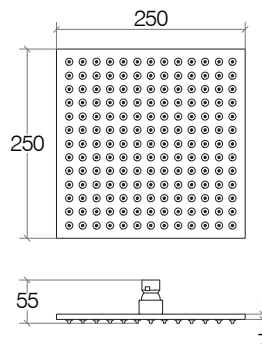

**Acciaio inox lucido**  
 Polished stainless steel  
 Acier inoxydable brillant  
 Poliert Edelstahl



.29

€ 127,00 - S

AISI  
304

### Soffione doccia quadro spessorato 7 mm con snodo 1/2"

53882.29

Thickened square shower head 7 mm, with 1/2" connection  
 Pomme de douche carrée épaisseur 7 mm, avec raccord 1/2"  
 Duschkopf quadratisch Dicke 7 mm mit Kugelgelenk G 1/2"

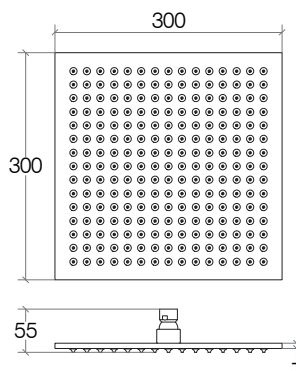

**Acciaio inox lucido**  
 Polished stainless steel  
 Acier inoxydable brillant  
 Poliert Edelstahl



.29

€ 138,00 - S

AISI  
304

**Braccio doccia tondo a parete per snodo ½"**

Wall round shower-arm, ½" joint  
 Bras de douche mural, rond, raccord ½"  
 Brausearm , Wandmontage G ½" rund

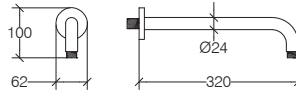
**53801.29**

**Ottone cromato**  
 Chromed brass  
 Laiton chromé  
 Verchromtes Messing

**.29**

€ 41,00 - S

**Braccio doccia tondo a parete per snodo ½"**

Wall round shower-arm, ½" joint  
 Bras de douche mural, rond, raccord ½"  
 Brausearm , Wandmontage G ½" rund

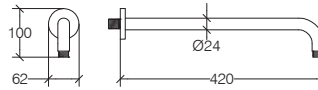
**53802.29**

**Ottone cromato**  
 Chromed brass  
 Laiton chromé  
 Verchromtes Messing

**.29**

€ 46,00 - S

**Rinforzo per braccio tondo**

Round sure grip shower-arm flange  
 Bras de douche mural, rond, raccord ½"  
 Verstärkung für Brausearm rund

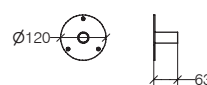
**53802R.29**

**Ottone cromato**  
 Chromed brass  
 Laiton chromé  
 Verchromtes Messing

**.29**

€ 46,00 - S



## Supioni

### Braccio doccia quadro a parete per snodo 1/2"

Wall square shower-arm, 1/2" joint  
Bras de douche mural, carré, raccord 1/2"  
Brausearm, Wandmontage G 1/2" quadratisch

**53806.29**

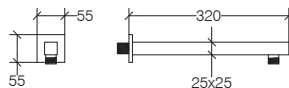

Ottone cromato  
Chromed brass  
Laiton chromé  
Verchromtes Messing



.29

€ 49,00 - S

### Braccio doccia quadro a parete per snodo 1/2"

Wall square shower-arm, 1/2" joint  
Bras de douche mural, carré, raccord 1/2"  
Brausearm, Wandmontage G 1/2" quadratisch

**53807.29**

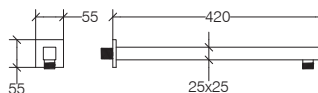

Ottone cromato  
Chromed brass  
Laiton chromé  
Verchromtes Messing



.29

€ 64,00 - S

### Rinforzo per braccio doccia quadro a parete per snodo 1/2"

Square sure grip shower-arm flange 1/2" joint  
Plaque de support pour bras de douche carré raccord 1/2"  
Verstärkung für Brausearm quadratisch Wandmontage G 1/2"

**53807R.29**

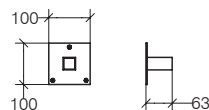

Ottone cromato  
Chromed brass  
Laiton chromé  
Verchromtes Messing



.29

€ 49,00 - S

**Braccio doccia a soffitto tondo per snodo ½"**

Ceiling round shower-arm, ½" joint  
 Bras de douche de plafond, rond, raccord ½"  
 Brausearm , Deckenmontage G ½" rund

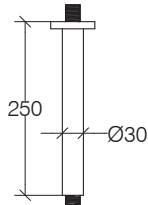
**53804.29**

**Ottone cromato**  
 Chromed brass  
 Laiton chromé  
 Verchromtes Messing

**.29**

€ 43,00 - S

**Braccio doccia a soffitto quadro per snodo ½"**

Ceiling square shower-arm, ½" joint  
 Bras de douche de plafond, carré, raccord ½"  
 Brausearm Deckenmontage G ½" quadratisch

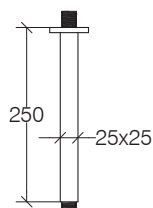
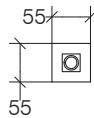
**53808.29**

**Ottone cromato**  
 Chromed brass  
 Laiton chromé  
 Verchromtes Messing

**.29**

€ 42,00 - S



## **Colonne doccia e doccette**

*Shower columns and hand shower*

*Colonnes de douche et douchettes*

*Duschsäulen und Handbrause*



**Doccetta quadrata**

Square hand shower  
Douchette carrée  
Handbrause quadratisch

**541712.29**

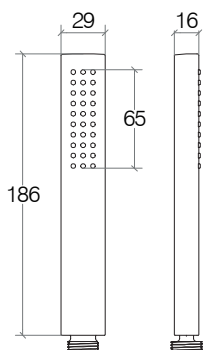

**ABS cromato**  
Chromed ABS  
ABS chromé  
Verchromtes ABS



€ 17,00 - S

**Doccetta cilindrica**

Round hand shower  
Douchette cylindrique  
Handbrause rund

**541713.29**

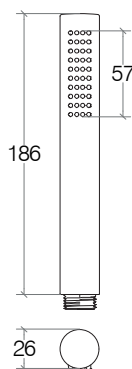

**ABS cromato**  
Chromed ABS  
ABS chromé  
Verchromtes ABS



€ 16,00 - S

**Doccetta, 3 getti regolabili**

Hand shower with 3 jets  
Douchette massage avec 3 jets  
Handbrause 3 Strahlarten

**541721.29**

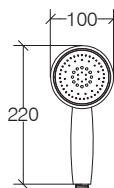

**ABS cromato**  
Chromed ABS  
ABS chromé  
Verchromtes ABS



€ 22,00 - S



## Docia

### Doccetta

Hand shower  
Douchette  
Handbrause

**541723.29.09**

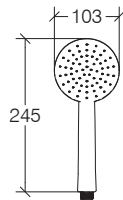

**ABS cromato**  
Chromed ABS  
ABS chromé  
Verchromtes ABS



**.29.09**

€ 19,00 - S

### Flessibile doppia maglia 1500 mm, con attacco conico da 1/2"

Double seam flexible hose 1500 mm, with 1/2" connection  
Flexible 1500 mm, raccord G 1/2"  
Brausenschlauch 1500 mm, konische Mutter G 1/2"

**541701.29**

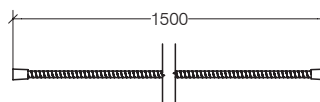

**Ottone cromato**  
Chromed brass  
Laiton chromé  
Verchromtes Messing



**.29**

€ 20,00 - S

### Flessibile PVC 1500 mm, con attacco conico da 1/2"

PVC flexible hose 1500 mm, with 1/2" connection  
Flexible PVC 1500 mm, raccord G 1/2"  
Brausenschlauch aus PVC 1500 mm, konische Mutter G 1/2"

**541702.29**

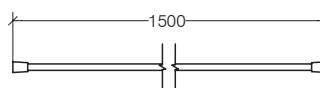

**PVC argento**  
Silver PVC  
PVC argent  
Silber PVC



**.29**

€ 25,00 - S

**Supporto a muro per doccetta**

Hand shower support  
Support pour douchette  
Wandhalter für Handbrause

**541714.29**

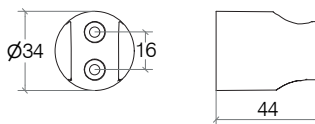

**ABS cromato**  
Chromed ABS  
ABS chromé  
Verchromtes ABS



.29

€ 12,00 - S



**Colonna doccia con deviatore, flessibile, doccetta cilindrica, altezza regolabile**

Equipped shower column with diverter and hose, hand shower, adjustable height  
Colonne de douche avec inverseur, flexible, douchette, hauteur réglable  
Brausestange mit Umsteller, Schlauch, Handbrause und höhenverstellbar

**54180.29**

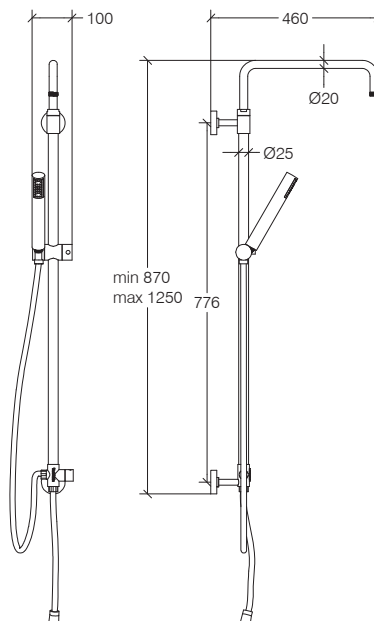

**Ottone cromato**  
Chromed brass  
Laiton chromé  
Verchromtes Messing



.29

€ 325,00 - L



## Docia

### Asta saliscendi tubo tondo

Round sliding rail  
Barre de douche ronde  
Runde Brausestange

54174.29

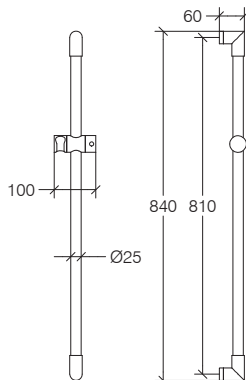

Ottone cromato  
Chromed brass  
Laiton chromé  
Verchromtes Messing



.29

€ 143,00 - M

### Asta saliscendi tubo rettangolare

Square sliding rail  
Barre de douche rectangulaire  
Rechteckige Brausestange

54175.29

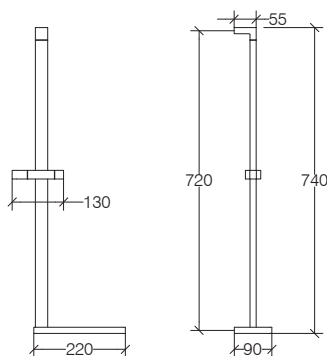

Ottone cromato  
Chromed brass  
Laiton chromé  
Verchromtes Messing



.29

€ 61,00 - S

**Puliscivetro in silicone**

**53288.17**

Silicon glass wiper  
Raclette de douche en silicone  
Scheibenwischer aus Silikon

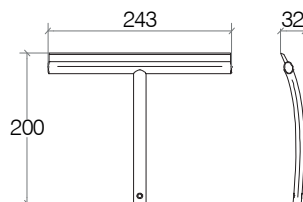

Silicone  
Silicon  
Silicone  
Silikon



.17

€ 31,00 - S

**Puliscivetro per parete e pavimento**

**53289.29**

Adjustable glass wiper 1 mt / wall and floor  
Raclette de douche 1 mt démontable  
Scheibenwischer für Wand und Boden

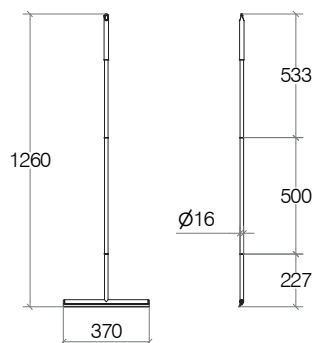

Acciaio inox/silicone  
Stainless steel/silicon  
Acier inoxydable/silicone  
Edelstahl/Silikon



.29

€ 80,00 - S

**Puliscivetro acciaio/silicone**

**53290.17**

Glass wiper / stainless steel / silycon  
Raclette de douche, acier et silicone  
Scheibenwischer

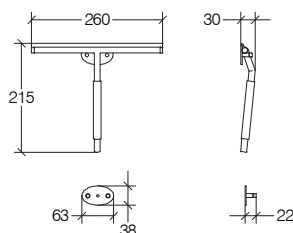

Acciaio inox/silicone  
Stainless steel/silicon  
Acier inoxydable/silicone  
Edelstahl/Silikon



.17

€ 38,00 - S

## Docia

### Tenda doccia waterproof

Waterproof shower curtain  
Rideau de douche imperméable  
Duschvorhang wasserdicht

71801.nn

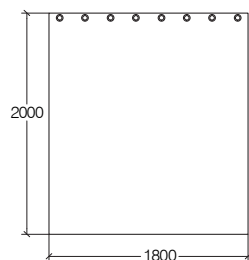

Poliestere  
Polyester  
Polyester  
Polyester



.09

.53

ITALY

€ 75,00 - S

### Tubo per doccia ad angolo (accorciabile)

Corner shower curtain holder (can be shortened)  
Support angle pour rideau de douche (raccourcissable)  
Eckige Halterung für Duschvorhang (verkürzbar)

71804.29

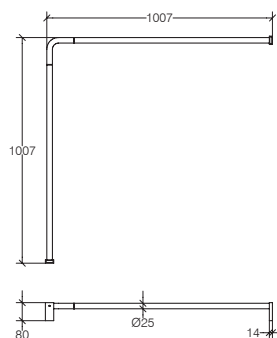

Ottone cromato  
Chromed brass  
Laiton chromé  
Verchromtes Messing



.29

€ 163,00 - S

### Tubo per doccia dritto (accorciabile)

Straight shower curtain holder (can be shortened)  
Support droit pour rideau de douche (raccourcissable)  
Halterung für Duschvorhang (verkürzbar)

71805.29

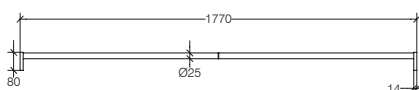

Ottone cromato  
Chromed brass  
Laiton chromé  
Verchromtes Messing



.29

€ 151,00 - S

**541713.29 Doccetta cilindrica cromo**

Round hand shower chrome / Douchette cylindrique chrome / Handbrause rund Chrom

**TA-DOCCIAT**

**541702.29 Flessibile PVC 1500 mm, con attacco conico da 1/2"**

PVC flexible hose 1500 mm, with 1/2" connection

Flexible PVC 1500 mm, raccord G 1/2"

Brausenschlauch aus PVC 1500 mm, konische Mutter G 1/2"

**54198.29 Presa acqua tonda con supporto doccetta**

Round water outlet with shower hook

Sortie d'eau ronde avec crochet pour douchette

Wandanschlussbogen rund mit Brausehalterung

**Ottone cromato**  
Chromed brass  
Laiton chromé  
Verchromtes Messing

**ABS cromato**  
Chromed ABS  
ABS chromé  
Verchromtes ABS



.29

€ 72,00 - M

**541712.29 Doccetta quadrata cromo**

Square hand shower chrome / Douchette carrée chrome / Handbrause quadratisch Chrom

**TA-DOCCIAQ**

**541702.29 Flessibile PVC 1500 mm, con attacco conico da 1/2"**

PVC flexible hose 1500 mm, with 1/2" connection

Flexible PVC 1500 mm, raccord G 1/2"

Brausenschlauch aus PVC 1500 mm, konische Mutter G 1/2"

**54199.29 Presa acqua quadra con supporto doccetta**

Square water outlet with shower hook

Sortie d'eau carrée avec crochet pour douchette

Wandanschlussbogen quadratisch mit Brausehalterung

Wandanschlussbogen rund mit Brausehalterung

**Ottone cromato**  
Chromed brass  
Laiton chromé  
Verchromtes Messing

**ABS cromato**  
Chromed ABS  
ABS chromé  
Verchromtes ABS



.29

€ 79,00 - M



## Griglie e accessori doccia

Shower baskets and shower accessories / Paniers et accessoires douche / Duschkörbe und Duschzubehöre

### IT

#### Filo:

dal latino 'filum', deriva da 'findere', cioè tagliare, dividere.

Oggetti indispensabili per contenere in maniera organizzata tutto ciò che è utile per la cura del corpo.

Acciaio inox lucido o satinato, verniciato bianco o nero o ottone cromato.

### EN

#### Filo:

*from the Latin 'filum'; it derives from 'findere', which means to cut, divide.*

*Essential objects to contain and organize all body care items.*

*Polished or satin-finished stainless steel, painted white or black, or chromed brass.*

### FR

#### Filo :

*du latin « filum », il dérive de « findere », c'est-à-dire couper, diviser.*

*Objets essentiels pour ranger de manière organisée tout ce qui peut être utile pour le soin du corps.*

*Acier inox brillant ou satiné, verni blanc ou noir ou laiton chromé.*

### DE

#### Filo:

*aus dem Lateinischen 'filum', abgeleitet von 'findere', also schneiden, trennen.*

*Unverzichtbare Objekte für die organisierte Aufbewahrung all dessen, was der Körperpflege dient.*

*Edelstahl glänzend oder satiniert, weiß oder schwarz lackiert oder Messing verchromt.*



**Griglia doccia angolare**

Corner shower basket  
Panier douche angulaire  
Seifenablage eckig

**50034.nn**

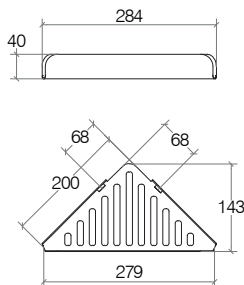

**Alluminio verniciato**  
Painted aluminium  
Aluminium laqué  
Lackiertem Aluminium



.09 .18  
€ 60,00 - S

**Acciaio inox lucido**  
Polished stainless steel  
Acier inoxydable brillant  
Poliert Edelstahl

**Acciaio inox satinato**  
Satinated stainless steel  
Acier inoxydable satiné  
Vereist Edelstahl



.29 .32  
€ 73,00 - S



**Griglia doccia**

Shower basket  
Panier douche  
Seifenablage

**50035.nn**

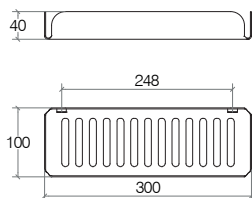
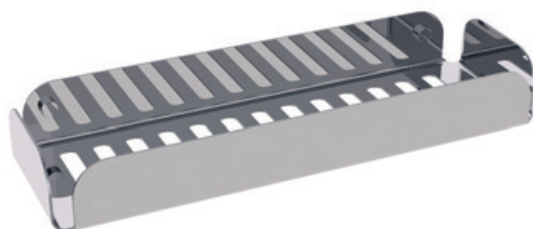

**Alluminio verniciato**  
Painted aluminium  
Aluminium laqué  
Lackiertem Aluminium



.09 .18  
€ 60,00 - S

**Acciaio inox lucido**  
Polished stainless steel  
Acier inoxydable brillant  
Poliert Edelstahl

**Acciaio inox satinato**  
Satinated stainless steel  
Acier inoxydable satiné  
Vereist Edelstahl

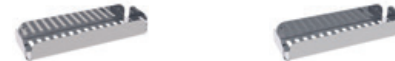

.29 .32  
€ 73,00 - S



**Griglia doccia angolare**

Corner shower basket  
Panier douche angulaire  
Seifenablage eckig

**50002.29**

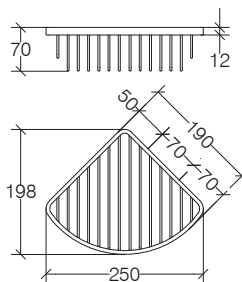

**Ottone cromato**  
Chromed brass  
Laiton chromé  
Verchromtes Messing



.29

€ 46,00 - S



## Filo

### Griglia doccia angolare

Corner shower basket  
Panier douche angulaire  
Seifenablage eckig

**50003.29**

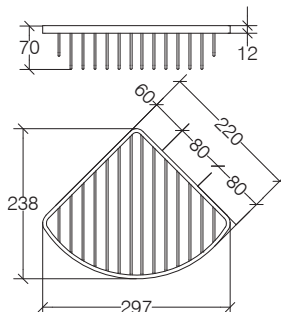

Ottone cromato  
Chromed brass  
Laiton chromé  
Verchromtes Messing



.29

€ 51,00 - S

### Griglia doccia angolare

Corner shower basket  
Panier douche angulaire  
Seifenablage eckig

**50011.29**

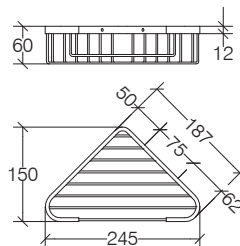
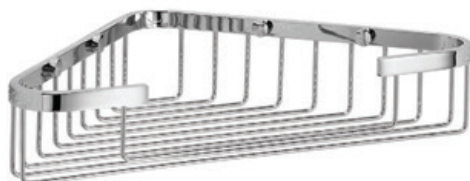

Ottone cromato  
Chromed brass  
Laiton chromé  
Verchromtes Messing



.29

€ 40,00 - S

### Griglia doccia angolare

Corner shower basket  
Panier douche angulaire  
Seifenablage eckig

**50012.29**

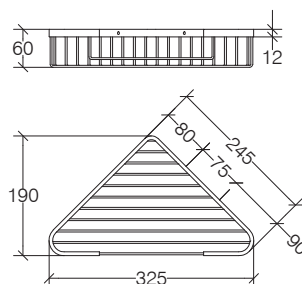
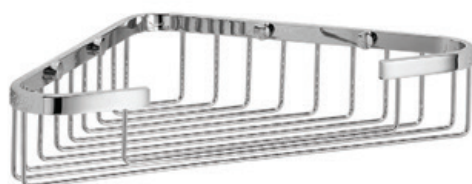

Ottone cromato  
Chromed brass  
Laiton chromé  
Verchromtes Messing



.29

€ 49,00 - S

**Griglia doccia angolare**

Corner shower basket  
Panier douche angulaire  
Schwammkorb für Dusche

**50013.29**

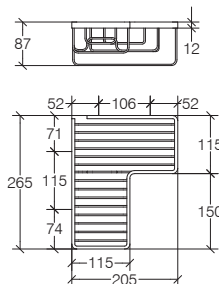

Ottone cromato  
Chromed brass  
Laiton chromé  
Verchromtes Messing



.29

€ 60,00 - S

**Portaoggetti da doccia**

Basket for shower  
Panier douche porte-objets  
Schwammkorb für Dusche

**50021.29**

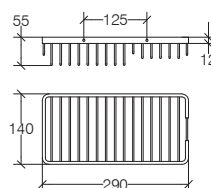
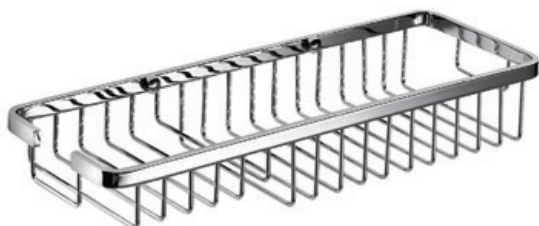

Ottone cromato  
Chromed brass  
Laiton chromé  
Verchromtes Messing



.29

€ 51,00 - S

**Portaoggetti da doccia**

Basket for shower  
Panier douche porte-objets  
Schwammkorb für Dusche

**50022.29**

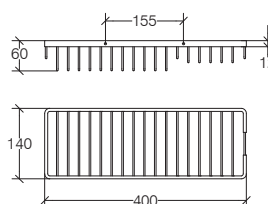
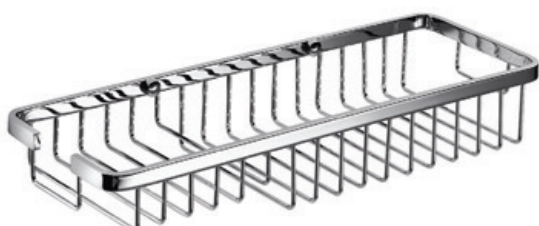

Ottone cromato  
Chromed brass  
Laiton chromé  
Verchromtes Messing



.29

€ 61,00 - S



## Filo

### Griglia doccia doppia, da appendere

Hanging double shower basket  
Panier douche double à accrocher  
Duschablage zum Hängen 2-fach

50030.29

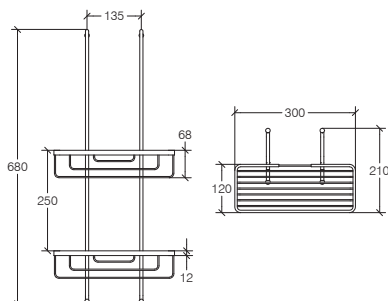

Ottone cromato  
Chromed brass  
Laiton chromé  
Verchromtes Messing



.29

€ 144,00 - M

### Griglia doccia doppia, da appendere

Hanging double shower basket  
Panier douche double à accrocher  
Duschablage zum Hängen 2-fach

50031.29

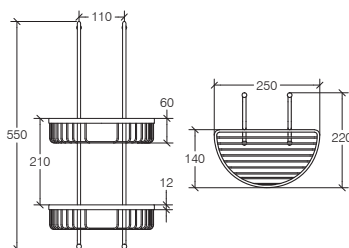

Ottone cromato  
Chromed brass  
Laiton chromé  
Verchromtes Messing



.29

€ 134,00 - M

**Griglia doccia angolare doppia**

Corner shower basket, double  
Panier douche double angulaire  
Duschablage 2-fach

**50032.29**

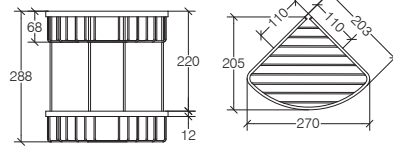

**Ottone cromato**  
Chromed brass  
Laiton chromé  
Verchromtes Messing



**.29**

€ 108,00 - M

**Griglia doccia angolare tripla**

Corner shower basket, triple  
Panier douche triple angulaire  
Duschablage 3-fach

**50033.29**

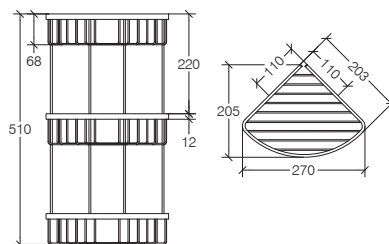

**Ottone cromato**  
Chromed brass  
Laiton chromé  
Verchromtes Messing



**.29**

€ 151,00 - M



Filo

**NEW**

**Griglia doccia da appendere con ripiano e specchio regolabile**

**50036.nn**

Shower basket with shelf and adjustable mirror / Panier douche avec tablette et miroir réglable  
Seifenablage mit Ablage und verstellbarem Spiegel

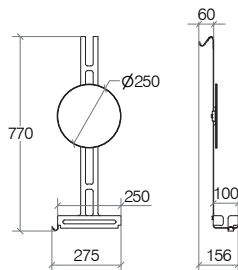

Alluminio verniciato  
Painted aluminium  
Aluminium laqué  
Lackiertem Aluminium



.09



.18

€ 250,00 - L

**Griglia doccia da appendere con due ripiani**

**50037.nn**

Shower basket with two shelf / Panier douche deux étagères  
Seifenablage mit zwei Ablagen

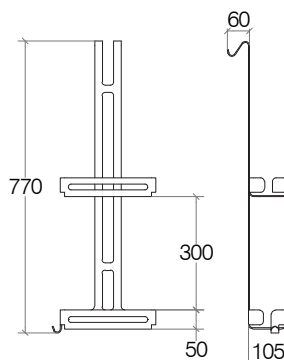

Alluminio verniciato  
Painted aluminium  
Aluminium laqué  
Lackiertem Aluminium



.09



.18

€ 162,00 - M

**Appendini per termoarredo e box doccia (12 pezzi)**

**50038.09**

Hooks for radiators and shower enclosure (12 pieces)  
Patère pour radiateur et douche (12 pièces)  
Haken für Heizkörper und Duschcabinen (12 Stk)

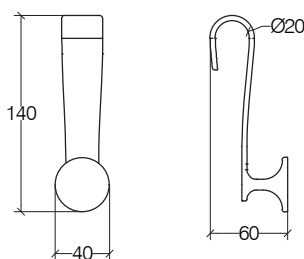

ABS bianco  
White ABS  
ABS blanc  
Weiß ABS



.09

€ 44,00 - S

**NEW**

**Filo**

**Portaoggetti da doccia**

Basket for shower  
Panier douche porte-objets  
Schwammkorb für Dusche

**50039.nn**

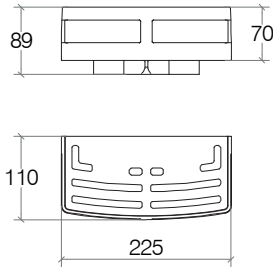
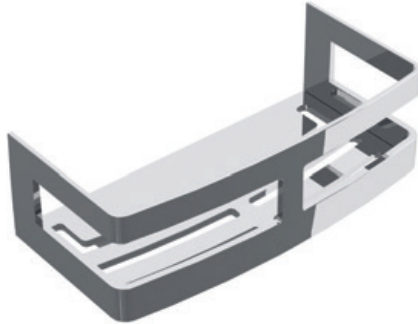

**ABS cromato**  
Chromed ABS  
ABS chromé  
Verchromtes ABS



**.29**

€ 60,00 - S

**ABS nero**  
Black ABS  
ABS noir  
ABS Schwarz



**.22**

€ 70,00 - S

**Griglia doccia angolare**

Corner shower basket  
Panier douche angulaire  
Seifenablage eckig

**50040.nn**

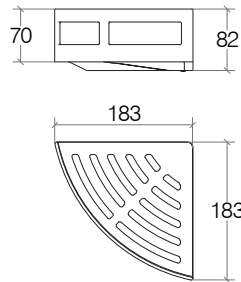
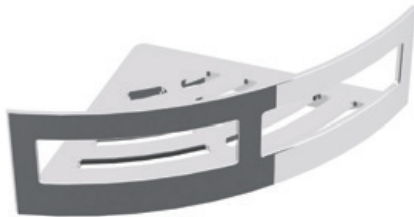

**ABS cromato**  
Chromed ABS  
ABS chromé  
Verchromtes ABS



**.29**

€ 55,00 - S

**ABS nero**  
Black ABS  
ABS noir  
ABS Schwarz



**.22**

€ 63,00 - S

**Appendino per termoarredo e box doccia**

Hook for radiator and shower box / Patère pour radiateur et douche / Hacken für Heizkörper und Duschkabine

**52964.nn**

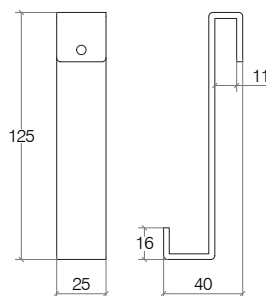

**Acciaio inox lucido**  
Polished stainless steel  
Acier inoxydable brillant  
Poliert Edelstahl



**.29**

**Acciaio inox satinato**  
Satinated stainless steel  
Acier inoxydable satiné  
Vereist Edelstahl



**.32**

€ 29,00 - S

## **Pedane doccia**

Shower mats / Caillebotis / Duschfußbrett



**Pedana doccia in multistrato marino**

Marine plywood shower mat  
Caillebotis douche en bois multicouche marin  
Duschfußbrett aus marine Sperrholz

**7224.08**

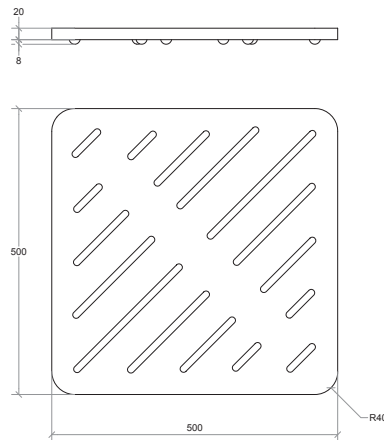

**Legno Okumè**  
Okumè wood  
Bois Okumè  
Holz Okumè



€ 84,00 - S

**Pedana doccia in multistrato marino**

Marine plywood shower mat  
Caillebotis douche en bois multicouche marin  
Duschfußbrett aus marine Sperrholz

**7225.08**

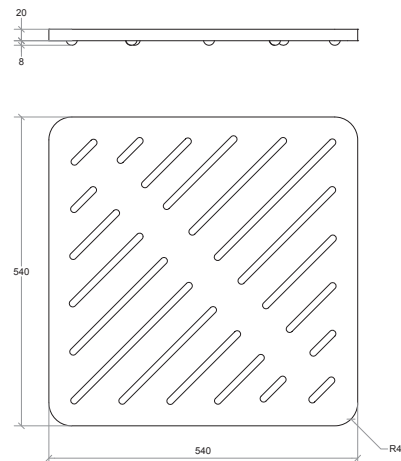

**Legno Okumè**  
Okumè wood  
Bois Okumè  
Holz Okumè



€ 93,00 - S

**Pedana doccia in multistrato marino**

Marine plywood shower mat  
Caillebotis douche en bois multicouche marin  
Duschfußbrett aus marine Sperrholz

**7226.08**

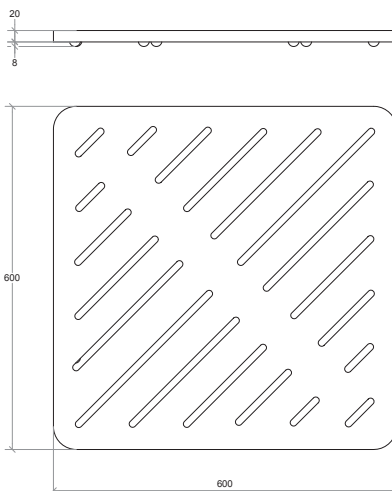

**Legno Okumè**  
Okumè wood  
Bois Okumè  
Holz Okumè



€ 109,00 - M



## Atlantica

### Pedana doccia in multistrato marino

Marine plywood shower mat  
Caillebotis douche en bois multicouche marin  
Duschfußbrett aus marine Sperrholz

7227.08

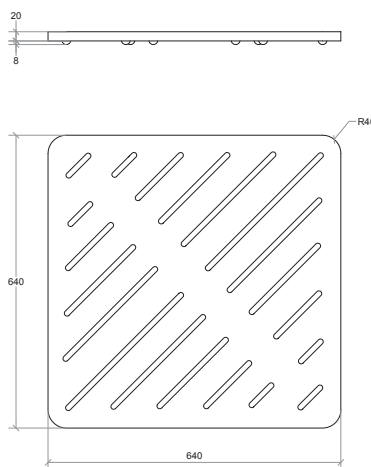

Legno Okumè  
Okumè wood  
Bois Okumè  
Holz Okumè



.08

€ 122,00 - M



### Pedana doccia in multistrato marino

Marine plywood shower mat  
Caillebotis douche en bois multicouche marin  
Duschfußbrett aus marine Sperrholz

72271.08

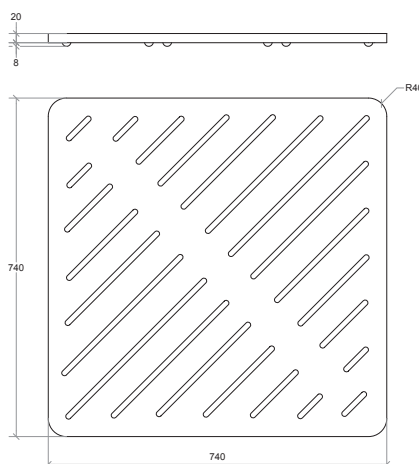

Legno Okumè  
Okumè wood  
Bois Okumè  
Holz Okumè



.08

€ 139,00 - M



### Pedana doccia in multistrato marino

Marine plywood shower mat  
Caillebotis douche en bois multicouche marin  
Duschfußbrett aus marine Sperrholz

7228.08

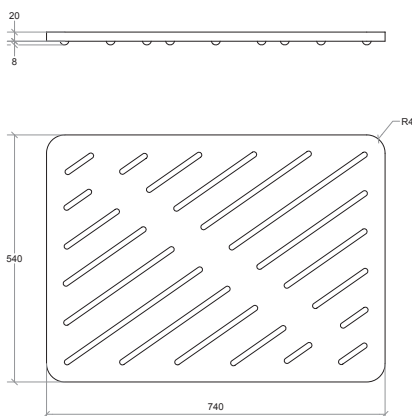

Legno Okumè  
Okumè wood  
Bois Okumè  
Holz Okumè



.08

€ 116,00 - M



**Pedana doccia in multistrato marino**

Marine plywood shower mat  
Caillebotis douche en bois multicouche marin  
Duschfußbrett aus marine Sperrholz

**7229.08**

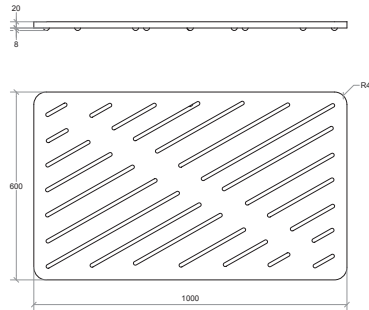

**Legno Okumè**  
Okumè wood  
Bois Okumè  
Holz Okumè



.08

€ 163,00 - M



**Pedana doccia in multistrato marino**

Marine plywood shower mat  
Caillebotis douche en bois multicouche marin  
Duschfußbrett aus marine Sperrholz

**7230.08**

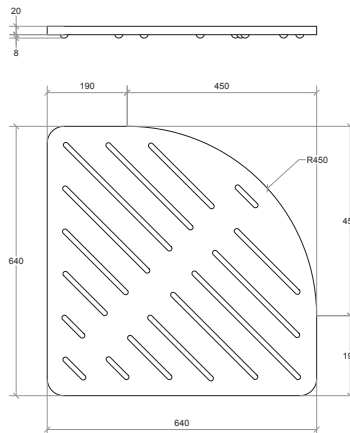

**Legno Okumè**  
Okumè wood  
Bois Okumè  
Holz Okumè



.08

€ 116,00 - M



**Ricambi / Spare parts / Pièces détachées / Ersatzteile**

<b>53830</b>	R1553830	Pedana doccia Okumè - Okumè wood shower base	<b>111,00</b>
<b>53915</b>	R22539152	Doccino cromato - Hand shower chrome	<b>28,00</b>
	R27539152	Doccino satinato - Hand shower brushed	<b>70,00</b>
	R22539153	Flessibile cromato - Flexible hose chrome	<b>28,00</b>
	R27539153	Flessibile satinato - Flexible hose brushed	<b>33,00</b>
	R22539151	Soffione per colonna inox lucido - Head shower stainless steel polished	<b>221,00</b>
	R27539151	Soffione per colonna inox satinato -Head shower stainless steel brushed	<b>221,00</b>
<b>53917</b>	R2253917	Cartuccia termostatica - Thermostatic cartige	<b>180,00</b>
<b>53810</b>	R2253807	Riduttore portata 6 l/m - Water flow regulator 6 l/m	<b>4,00</b>
	R25538101	Coppia viti maschio e femmina - Screw set	<b>4,00</b>
	R22538101	Ugello per soffione - Ozzle for shower head	<b>3,00</b>
	R2353810	Snodo per soffione - Articulated joint	<b>17,00</b>
	R2253810	Ricambio guarnizione per soffione 53810 Ø 180 - Spare part for gasket 53810 Ø 180 mm	<b>12,00</b>
	R22538102	Coppia guarnizioni per snodo soffione - Gasket couple for shower head joint	<b>4,00</b>
	R22538103	Guarnizione con filtro per snodo - Gasket with filter for shower head joint	<b>4,00</b>
<b>53811</b>	R2253807	Riduttore portata 6 l/m - Water flow regulator 6 l/m	<b>4,00</b>
	R25538101	Coppia viti maschio e femmina - Screw set	<b>4,00</b>
	R2353810	Snodo per soffione - Articulated joint	<b>17,00</b>
	R2253811	Kit guarnizione Ø 230 per art. 53811 - Gasket kit Ø 230 for art. 53811	<b>15,00</b>
	R22538101	Ugello per soffione - Ozzle for shower head	<b>3,00</b>
	R22538102	Coppia guarnizioni per snodo soffione - Gasket couple for shower head joint	<b>4,00</b>
	R22538103	Guarnizione con filtro per snodo - Gasket with filter for shower head joint	<b>4,00</b>
<b>53812</b>	R2253812	Riduttore portata 9 l/m - Water flow regulator 9 l/m	<b>4,00</b>
	R25538101	Coppia viti maschio e femmina - Screw set	<b>4,00</b>
	R2353810	Snodo per soffione - Articulated joint	<b>17,00</b>
	R22538121	Guarnizione Gasket	<b>15,00</b>
	R22538101	Ugello per soffione - Ozzle for shower head	<b>3,00</b>
	R22538102	Coppia guarnizioni per snodo soffione - Gasket couple for shower head joint	<b>4,00</b>
	R22538103	Guarnizione con filtro per snodo - Gasket with filter for shower head joint	<b>4,00</b>

## Ricambi / Spare parts / Pièces détachées / Ersatzteile

<b>53815</b>	R2253807	Riduttore portata 6 l/m- Water flow regulator 6 l/m	<b>4,00</b>
	R25538101	Coppia viti maschio e femmina - Screw set	<b>4,00</b>
	R2353810	Snodo per soffione - Articulated joint	<b>17,00</b>
	R2253815	Kit guarnizione 180x180 per art.53815 - Gasket kit Ø 180x180 for art.53815	<b>12,00</b>
	R22538101	Ugello per soffione - Ozzle for shower head	<b>3,00</b>
	R22538102	Coppia guarnizioni per snodo soffione - Gasket couple for shower head joint	<b>4,00</b>
	R22538103	Guarnizione con filtro per snodo - Gasket with filter for shower head joint	<b>4,00</b>
<b>53816</b>	R2253807	Riduttore portata 6 l/m- Water flow regulator 6 l/m	<b>4,00</b>
	R25538101	Coppia viti maschio e femmina - Screw set	<b>4,00</b>
	R2353810	Snodo per soffione - Articulated joint	<b>17,00</b>
	R2253816	Kit guarnizione 230X230 per art.53816 - Gasket kit 230x230 for art.53816	<b>15,00</b>
	R22538101	Ugello per soffione - Ozzle for shower head	<b>3,00</b>
	R22538102	Coppia guarnizioni per snodo soffione - Gasket couple for shower head joint	<b>4,00</b>
	R22538103	Guarnizione con filtro per snodo - Gasket with filter for shower head joint	<b>4,00</b>
<b>53817</b>	R2253812	Riduttore portata 9 l/m - Water flow regulator 9 l/m	<b>4,00</b>
	R25538101	Coppia viti maschio e femmina - Screw set	<b>4,00</b>
	R2253817	Kit guarnizione 300X300 per art.53817 - Gasket kit it 300X300 for art.53817	<b>17,00</b>
	R2353810	Snodo per soffione - Articulated joint	<b>17,00</b>
	R22538101	Ugello per soffione - Ozzle for shower head	<b>3,00</b>
	R22538102	Coppia guarnizioni per snodo soffione - Gasket couple for shower head joint	<b>4,00</b>
	R22538103	Guarnizione con filtro per snodo - Gasket with filter for shower head joint	<b>4,00</b>
<b>53801</b>	R2553801P	Placca rotonda per supporto doccia - Round platee for shower arm	<b>9,00</b>
<b>53802</b>	R2553801P	Placca rotonda per supporto doccia - Round platee for shower arm	<b>9,00</b>
<b>53804</b>	R2553801P	Placca rotonda per supporto doccia - Round platee for shower arm	<b>9,00</b>
<b>53806</b>	R2553806P	Placca quadra per supporto doccia - Square platee for shower arm	<b>10,00</b>
<b>53807</b>	R2553806P	Placca quadra per supporto doccia - Square platee for shower arm	<b>10,00</b>
<b>53808</b>	R2553806P	Placca quadra per supporto doccia - Square platee for shower arm	<b>10,00</b>
<b>53290</b>	R225329017	Gomma puliscivetri grigio - Shower cleaner grey rubber	<b>5,00</b>
	R22532902	Supporto puliscivetri gancio adesivo - Wall adhesive shower cleaner support	<b>10,00</b>
	R23532902	Supporto metallo con adesivo - Metal support with adhesive	<b>13,00</b>



## Ricambi / Spare parts / Pièces détachées / Ersatzteile

<b>54180</b>	R22541801	Flessibile 600 mm - 600 mm flexible hose	<b>9,00</b>
	R22541802	Supporto saliscendi per asta doccia - Shower ups and downs ho	<b>19,00</b>
	R22541803	Deviatore per colonna 54180 - Diverter for shower column 54180	<b>56,00</b>
	R22541804	O- ring asta doccia - Shower ups and downs O-ring	<b>3,00</b>
	R22541805	Guarnizione in PVC - PVC gasket	<b>3,00</b>
	541701.29	Flessibile doppia maglia 1500 mm, con attacco conico da ½" Double seam flexible hose 1500 mm, with ½" connection	<b>20,00</b>
<b>54174</b>	R22541802	Supporto saliscendi per asta doccia - Shower ups and downs hook	<b>19,00</b>
<b>54175</b>	R22541751	Saliscendi doccia ABS cromato quadro - Square chromed ABS ups and downs hook	<b>27,00</b>
	R22541752	Mensola doccia ABS cromato quadro - Square chromed ABS shelf	<b>27,00</b>
<b>71804</b>	R2071804	Kit fissaggio a muro - Wall mounting kit	<b>25,00</b>
<b>50002</b>	R2250014	Confezione 4 viti + 4 tasselli + 4 copriviti per griglia doccia - 4 screws + 4 raw plug + 4 screw covers set	<b>4,00</b>
<b>50003</b>	R2250014	Confezione 4 viti + 4 tasselli + 4 copriviti per griglia doccia - 4 screws + 4 raw plug + 4 screw covers set	<b>4,00</b>
<b>50011</b>	R2250014	Confezione 4 viti + 4 tasselli + 4 copriviti per griglia doccia - 4 screws + 4 raw plug + 4 screw covers set	<b>4,00</b>
<b>50012</b>	R2250014	Confezione 4 viti + 4 tasselli + 4 copriviti per griglia doccia - 4 screws + 4 raw plug + 4 screw covers set	<b>4,00</b>
<b>50013</b>	R2250014	Confezione 4 viti + 4 tasselli + 4 copriviti per griglia doccia - 4 screws + 4 raw plug + 4 screw covers set	<b>4,00</b>
<b>50021</b>	R2250012	Confezione 2 viti + 2 tasselli + 2 copriviti per griglia doccia - 2 screws + 2 raw plug + 2 screw covers set	<b>5,00</b>
<b>50022</b>	R2250012	Confezione 2 viti + 2 tasselli + 2 copriviti per griglia doccia - 2 screws + 2 raw plug + 2 screw covers set	<b>5,00</b>
<b>50030</b>	R2250030	Gommino plastica - Plastic rubber tip	<b>3,00</b>
<b>50031</b>	R2250030	Gommino plastica - Plastic rubber tip	<b>3,00</b>
<b>50032</b>	R2250014	Confezione 4 viti + 4 tasselli + 4 copriviti per griglia doccia - 4 screws + 4 raw plug + 4 screw covers set	<b>4,00</b>
<b>50033</b>	R2250014	Confezione 4 viti + 4 tasselli + 4 copriviti per griglia doccia - 4 screws + 4 raw plug + 4 screw covers set	<b>4,00</b>



# Hotel & Contract

*Contract / Hôtellerie / Hotel*



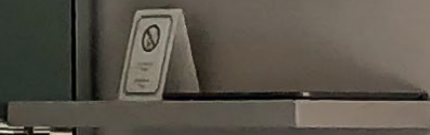

## Otel

### Asciugacapelli a parete 1200 Watt

Wall hairdryer - 1200 W / Sèche-cheveux électrique mural - 1200 W / Wand-Haartrockner - 1200 W

53262.09

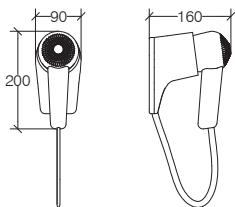

ABS  
ABS  
ABS  
ABS



.09

€ 54,00 - S

### Asciugacapelli a parete 1400 Watt

Wall hairdryer 1400 W / Sèche-cheveux électrique mural 1400 W - Wand-Haartrockner 1400 W

53263.nn

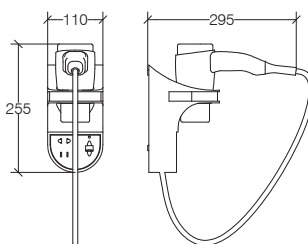

ABS  
ABS  
ABS  
ABS



.09



.18

€ 116,00 - M

### Maniglione di sicurezza reversibile con porta sapone

Reversible grab security bar with soap holder / Barre d'appui réversible avec porte-savon  
Sicherheitsgriff mit Seifenkorb reversibel

53101.29

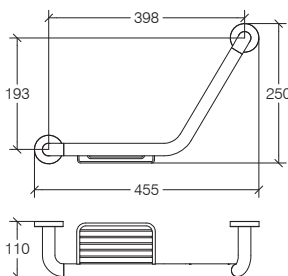

Ottone cromato  
Chromed brass  
Laiton chromé  
Verchromtes Messing



.29

€ 80,00 - S

### Asciugamani elettrico a parete in acciaio inox con attivazione sensore di movimento 220-240 V - 500 Watt

53266.29

Wall handdryer with motion sensor activation in stainless steel 220-240 V - 500 Watt  
Sèche-mains électrique avec capteur de mouvement en acier inox 220-240 V - 500 Watt  
Elektronischer Wandtrockner mit Sensor aus Edelstahl 220-240 V - 500 Watt

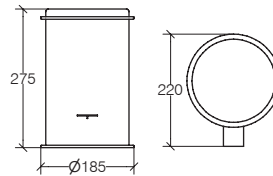

**Acciaio inox lucido**  
Polished stainless steel  
Acier inoxydable brillant  
Poliert Edelstahl



.29

€ 197,00 - M

### Maniglione di sicurezza reversibile

Reversible grab security bar / Barre d'appui réversible / Reversibel Sicherheitsgriff

53102.29

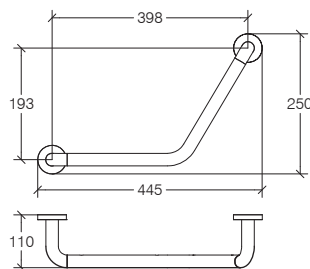

**Ottone cromato**  
Chromed brass  
Laiton chromé  
Verchromtes Messing



.29

€ 73,00 - S

## Otel

### Maniglione di sicurezza

Grab security bar / Barre d'appui / Sicherheitsgriff

53103.29

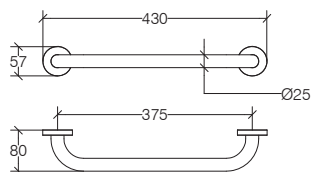

**Ottone cromato**  
Chromed brass  
Laiton chromé  
Verchromtes Messing



.29

€ 60,00 - S

### Maniglione di sicurezza

Grab security bar / Barre d'appui / Sicherheitsgriff

53104

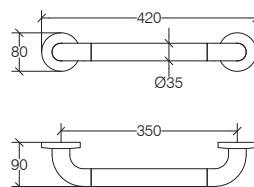

**Nylon - Acciaio inox**  
Nylon - stainless steel  
Nylon - acier inoxydable  
Nylon - Edelstahl



€ 42,00 - S



**Maniglione di sicurezza reversibile**

Reversible grab security bar / Barre d'appui réversible / Sicherheitsgriff wechelseitig

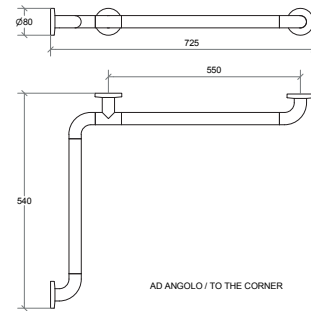
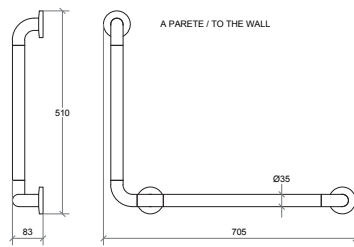
**53105**

**Nylon - Acciaio inox**  
 Nylon - Stainless steel  
 Nylon - Acier inoxydable  
 Nylon - Edelstahl



€ 88,00 - M

**Maniglione di sicurezza ribaltabile**

Folding safety support / Barre d'appui rabattable / Klapp-Sicherheitsgriff

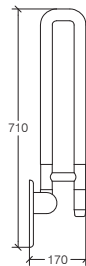
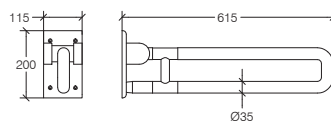
**53106**

**Nylon - Acciaio inox**  
 Nylon - Stainless steel  
 Nylon - Acier inoxydable  
 Nylon - Edelstahl



**Portata massima 360 Kg**  
 Max weight 360 Kg  
 Poids maximum 360 Kg  
 Maximales Gewicht 360 Kg



€ 216,00 - M

## Otel

### Dosatore a parete singolo 400 ml

Wall bearing liquid soap dispenser 400 ml / Distributeur savon liquide mural 400 ml / Wandseifenspender 400 ml

53267.29

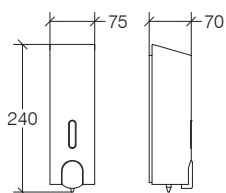

ABS cromato  
Chromed ABS  
ABS chromé  
verchromtes ABS



.29

€ 32,00 - S

### Salvagoccia

Drop-catcher / Protège-gouttes / Abtropfplatte

53269.29

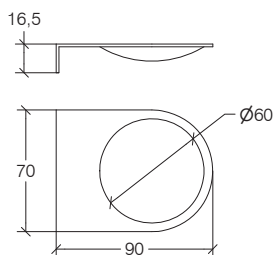
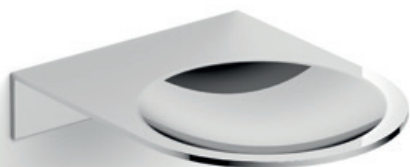

Acciaio inox lucido  
Polished stainless steel  
Acier inoxydable brillant  
Poliert Edelstahl



.29

€ 28,00 - S

### Porta fazzoletti da appoggio

Table kleenexbox / Porte-mouchoirs à poser / Kleenexbox am Tisch

53270.29

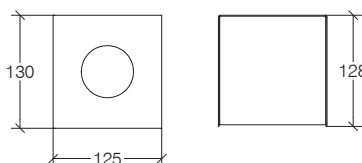

Acciaio inox lucido  
Polished stainless steel  
Acier inoxydable brillant  
Poliert Edelstahl



.29

€ 53,00 - S

**Porta fazzoletti da appoggio**

Table kleenexbox / Porte-mouchoirs à poser ou mural / Kleenexbox am Tisch / Wand

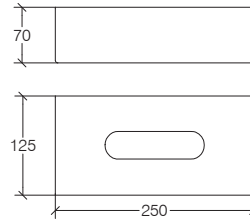
**53271.29**

**Acciaio inox lucido**  
Polished stainless steel  
Acier inoxydable brillant  
Poliert Edelstahl

**.29**

ITALY

€ 53,00 - S

**Porta sacchetti igienici a muro**

Wall sanitary bag holder / Distributeur sachets hygiéniques mural / Hygienebeutelspender am Wand

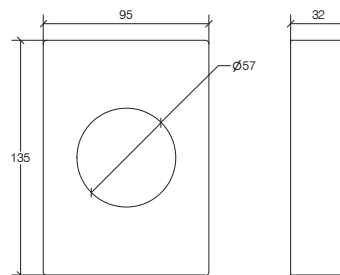
**53272.29**

**Acciaio inox lucido**  
Polished stainless steel  
Acier inoxydable brillant  
Poliert Edelstahl

**.29**

ITALY

€ 38,00 - S

**Porta fazzoletti da parete e da appoggio**

Wall/table kleenexbox / Porte-mouchoirs à poser ou mural / Kleenexbox am Tisch/Wand

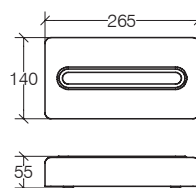
**53291.29**

**Acciaio inox lucido**  
Polished stainless steel  
Acier inoxydable brillant  
Poliert Edelstahl

**.29**

€ 53,00 - S

## Otel

### Distributore jumbo carta igienica

Distributore jumbo carta igienica / Distributeur de papier hygiénique Jumbo / Spender für Toilettenpapier Jumbo

53292.29

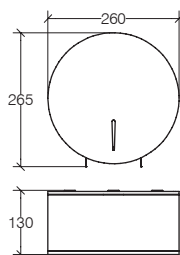

**Acciaio inox lucido**  
Polished stainless steel  
Acier inoxydable brillant  
Poliert Edelstahl



.29

€ 105,00 - S

### Porta sacchetti igienici

Jumbo roll toilet tissue dispenser / Porte sachets hygiéniques / Spender für Toilettenpapier Jumbo

53293.29

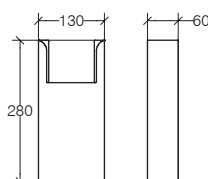

**Acciaio inox lucido**  
Polished stainless steel  
Acier inoxydable brillant  
Poliert Edelstahl



.29

€ 42,00 - S

### Distributore asciugamani di carta

Paper towels dispenser / Distributeur de serviettes en papier / Papiertücherspender

53294.29

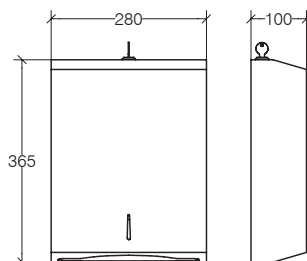

**Acciaio inox lucido**  
Polished stainless steel  
Acier inoxydable brillant  
Poliert Edelstahl



.29

**Dimensione fazzoletti 225x105 mm**

Handkerchief size 225x105 mm

Taille du mouchoir 225x105 mm

Taschentuch Größe 225x105 mm

€ 133,00 - S



**Bidoncino da tavolo tondo**

Round table paper bin / Petite poubelle de table ronde / Tischabfallbehälter rund

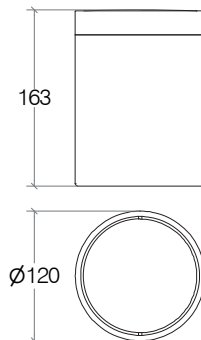
**44019.29**

**Acciaio inox lucido**  
*Polished stainless steel*  
*Acier inoxydable brillant*  
*Poliert Edelstahl*

**.29**

€ 54,00 - S

**Bidoncino da tavolo quadrato**

Square table paper bin / Petite poubelle de table carrée / Tischabfallbehälter quadratisch

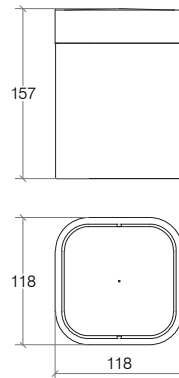
**44020.nn**

**Acciaio inox lucido**  
*Polished stainless steel*  
*Acier inoxydable brillant*  
*Poliert Edelstahl*

**.29**

€ 54,00 - M

**Bidoncino da tavolo tondo**

Round table paper bin / Petite poubelle de table ronde / Tischabfallbehälter rund

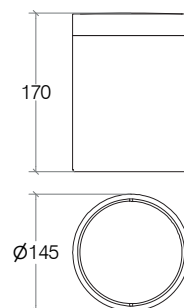
**5359.22**

**Acciaio inox verniciato**  
*Painted stainless steel*  
*Acier inoxydable laqué*  
*Lackiertem Edelstahl*

**.22**

€ 111,00 - M

## Otel

### Filo stendibiancheria 250 mm, portata 3 kg

Retractable clothesline 250 mm, max weight 3 kg for inhouse use

Fil étendoir 250 mm, portée 3 kg

Wäscheleine 250 mm, Tragfähigkeit 3 Kg

**53295.29**



#### Acciaio inox lucido

Polished stainless steel

Acier inoxydable brillant

Poliert Edelstahl



.29

€ 34,00 - S

**Ricambi / Spare parts / Pièces détachées / Ersatzteile**

<b>53267</b>	R22532672	Pompetta ABS per dosatori 53267 - ABS pump for dispensers art. 53267	<b>7,00</b>
	R22532673	Flacone 350 ml - 350 ml bottle	<b>5,00</b>
	R22532674	Pulsante in plastica - Plastic button	<b>10,00</b>
<b>53292</b>	R23532921	Chiavetta per distributore 53292 - Key for dispenser 53292	<b>4,00</b>
<b>53294</b>	R23532941	Ricambio serratura con chiave - Key and lock replacement	<b>7,00</b>



# Sifoni, Pilette & Rubinetteria

*Siphons, water drains, taps and fittings*  
*Siphons, bondes et robinetterie*  
*Siphons, Ablaufgarnituren und Armaturen*

## **Sifoni / 396**

*Siphons / Siphons / Siphons*

## **Pilette / 398**

*Water drains / Bondes / Ablaufgarnituren*

## **Prese acqua / 401**

*Water outlet / Sorties d'eau / Wandanschlussbogen*

## **Rubinetteria / 403**

*Taps and fittings / Robinetterie / Armaturen*



## Busi e Cane

### Sifone 1"-1/4 mm

Siphon, 1"-1/4 mm / Siphon 1"1/4 mm / Siphon 1" 1/4 mm

5392.29

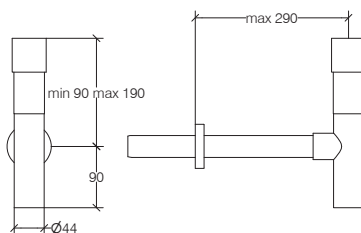

Ottone cromato  
Chromed brass  
Laiton chromé  
Verchromtes Messing



.29

€ 83,00 - S

### Sifone salvaspazio, 1"-1/4 mm

Space saving siphon, 1"-1/4 mm / Siphon gain de place 1"1/4 mm / Siphon platzsparend 1" 1/4 mm

53921.nn

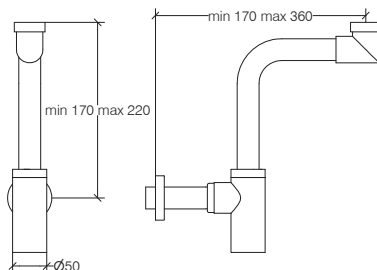

Ottone cromato  
Chromed brass  
Laiton chromé  
Verchromtes Messing



.29

€ 102,00 - S

Ottone verniciato  
Painted brass  
Laiton laqué  
Lackiertem Messing



.22

€ 107,00 - S

### Sifone 1"-1/4 mm

Siphon, 1"-1/4 mm / Siphon 1"1/4 mm / Siphon 1" 1/4 mm

53922.nn

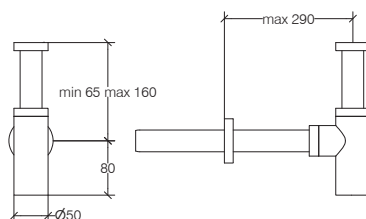

Ottone cromato  
Chromed brass  
Laiton chromé  
Verchromtes Messing



.29

€ 60,00 - S

Ottone verniciato  
Painted brass  
Laiton laqué  
Lackiertem Messing



.22

€ 80,00 - S

**Sifone quadro 1"-1/4 mm**

Square siphon, 1"- 1/4 mm / Siphon carré 1"1/4 mm / Siphon quadratisch 1" 1/4 mm

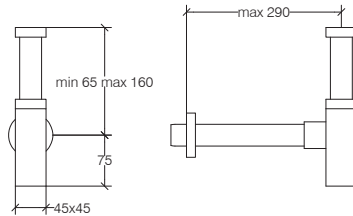
**53925.29**

**Ottone cromato**  
Chromed brass  
Laiton chromé  
Verchromtes Messing

**.29**

€ 70,00 - S

**Sifone per bidet, 1"-1/4 mm**

Bidet siphon 1"- 1/4 mm / Siphon bidet 1" 1/4 mm / Bidet Siphon 1" 1/4 mm

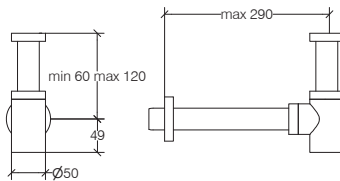
**53926.nn**

**Ottone cromato**  
Chromed brass  
Laiton chromé  
Verchromtes Messing

**.29**

€ 53,00 - S

**Ottone verniciato**  
Painted brass  
Laiton laqué  
Lackiertem Messing

**.22**

€ 70,00 - S

**Sifone salvaspazio, 1"-1/4 mm**

Space saving siphon, 1"-1/4 mm / Siphon gain de place 1"1/4 mm / Siphon platzsparend 1" 1/4 mm

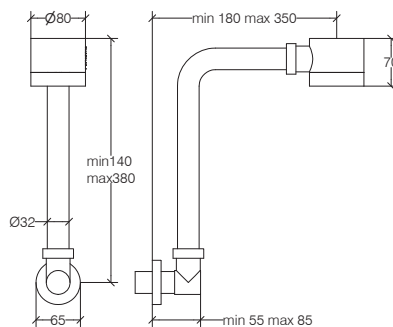
**53927.29**

**Ottone cromato**  
Chromed brass  
Laiton chromé  
Verchromtes Messing

**.29**

€ 97,00 - S

## Busi e Cane

### Ghiera appoggio vasche sopraiano

Support nut for washbasins/ Écrou de support pour vasques à poser / Aufsatzring für Waschbecken

5398.29

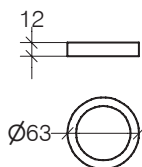

Ottone cromato  
Chromed brass  
Laiton chromé  
Verchromtes Messing



.29

€ 17,00 - S

### Piletta click regolabile 0-60 mm, 1" 1/4"

Automatic floor waste water drain adaptable 0-60 mm 1" 1/4" / Bonde automatique réglable 0-60 mm 1" 1/4" / Druck-Ablaufgarnitur verstellbar 1" 1/4"

53961.nn

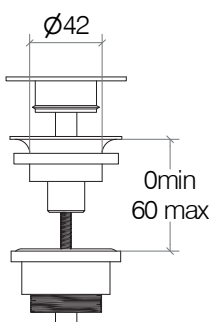

Ottone cromato  
Chromed brass  
Laiton chromé  
Verchromtes Messing



.29

€ 29,00 - S

Ottone verniciato  
Painted brass  
Laiton laqué  
Lackiertem Messing



.22

€ 33,00 - S

### Piletta scarico libero, 1"- 1/4 mm

Free waste water drain, 1"- 1/4 mm / Bonde à écoulement libre / Freie Ablaufgarnitur 1" 1/4

53972.29

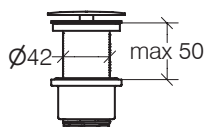

Ottone cromato  
Chromed brass  
Laiton chromé  
Verchromtes Messing



.29

€ 28,00 - S

### Piletta scarico libero, 1"- 1/4 mm

Free waste water drain, 1"- 1/4 mm / Bonde à écoulement libre / Freie Ablaufgarnitur 1" 1/4

53975.29

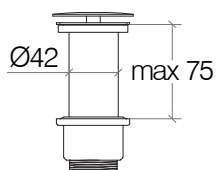

Ottone cromato  
Chromed brass  
Laiton chromé  
Verchromtes Messing



.29

€ 30,00 - S



**Piletta automatica click con troppopieno**

**53976.nn**

Automatic waste water drain with overflow / Bonde automatique avec trop-plein / Druck-Ablaufgarnitur mit Überlauf

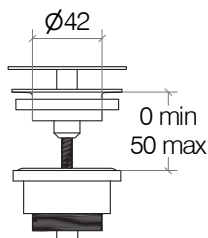

**Ottone cromato**  
Chromed brass  
Laiton chromé  
Verchromtes Messing

**Ottone verniciato**  
Painted brass  
Laiton laqué  
Lackiertem Messing



**.29**

**.22**

€ 30,00 - S

€ 33,00 - S

**Piletta regolabile klik 0-80 mm con tappo in ceramica**

**53977.nn**

Adjustable drain water drain 0-80 mm with ceramic cap / Bonde ajustable 0-80 mm avec bouchon en céramique  
Einstellbarer Abfluss 0-80 mm mit Keramikcappe

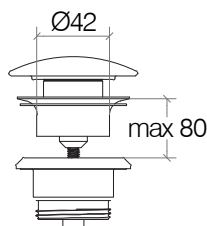

**Bianca lucida**  
Glossy white  
Blanc brillant  
Glänzend weiÙe

**Antracite**  
Anthracite  
Anthracite  
Anthrazit

**Bianca opaca**  
Matt white  
Blanc mat  
MattweiÙe



**.09**

**.17**

**.26**

€ 88,00 - M

€ 128,00 - M

€ 128,00 - M

**Piletta klik con troppopieno max 50 mm**

**53991.nn**

Automatic waste water drain with overflow max height 50 mm / Bonde automatique avec trop-plein max 50 mm  
Druck-Ablaufgarnitur mit Überlauf max 50 mm

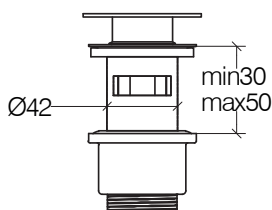

**Ottone cromato**  
Chromed brass  
Laiton chromé  
Verchromtes Messing

**Ottone verniciato**  
Painted brass  
Laiton laqué  
Lackiertem Messing



**.29**

**.22**

€ 30,00 - S

€ 33,00 - S

## Busi e Cane

### Piletta click con troppopieno

Waste water drain with overflow / Bonde avec trop-plein / Druck-Ablaufgarnitur mit Überlauf

**53992.29**

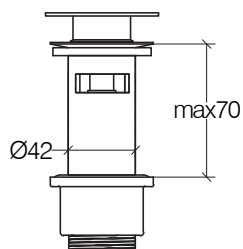

Ottone cromato  
Chromed brass  
Laiton chromé  
Verchromtes Messing



.29

€ 33,00 - S

### Piletta click senza troppopieno

Waste water drain without overflow / Bonde sans trop-plein / Druck-Ablaufgarnitur ohne Überlauf

**53994.29**

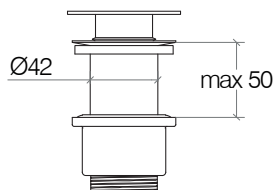

Ottone cromato  
Chromed brass  
Laiton chromé  
Verchromtes Messing



.29

€ 29,00 - S

### Piletta click senza troppopieno

Waste water drain without overflow / Bonde sans trop-plein / Druck-Ablaufgarnitur ohne Überlauf

**53995.29**

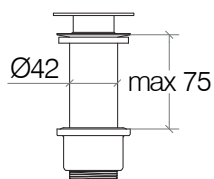

Ottone cromato  
Chromed brass  
Laiton chromé  
Verchromtes Messing



.29

€ 32,00 - S

**Busi e Cane**

**Prese acqua tonda con supporto doccia**

Round water outlet with shower hook / Sortie d'eau ronde avec crochet pour douchette / Wandanschlussbogen rund mit Brausehalterung

**54198.29**

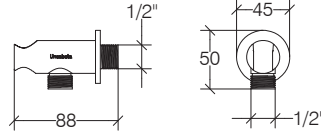

**Ottone cromato**  
Chromed brass  
Laiton chromé  
Verchromtes Messing



**.29**

€ 36,00 - S

**Prese acqua quadra con supporto doccia**

Square water outlet with shower hook / Sortie d'eau carrée avec crochet pour douchette / Wandanschlussbogen quadratisch mit Brausehalterung

**54199.29**

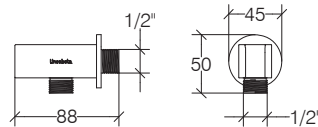

**Ottone cromato**  
Chromed brass  
Laiton chromé  
Verchromtes Messing



**.29**

€ 41,00 - S

**Prese acqua tonda, uscita 1/2"**

Round water outlet 1/2" / Sortie d'eau ronde, 1/2" / Wandanschlussbogen 1/2"

**54203.29**

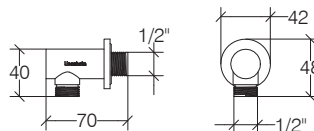

**Ottone cromato**  
Chromed brass  
Laiton chromé  
Verchromtes Messing



**.29**

€ 20,00 - S



## Busi e Cane

### Preso acqua quadra, uscita 1/2"

Square water outlet 1/2" / Sortie d'eau carrée, 1/2" / Wandanschlussbogen quadratisch 1/2"

**54204.29**

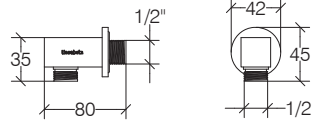

Ottone cromato  
Chromed brass  
Laiton chromé  
Verchromtes Messing



.29

€ 22,00 - S

### Rubinetto arresto tondo uscita 3/8"

Concealed stop valve round with connection 3/8" / Robinet d'arrêt rond sortie 3/8" / Unterputzstopventil rund Anschluß 3/8"

**54208.29**

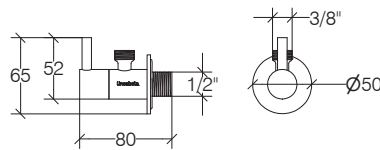

Ottone cromato  
Chromed brass  
Laiton chromé  
Verchromtes Messing



.29

€ 27,00 - S

Ottone verniciato  
Painted brass  
Laiton laqué  
Lackiertem Messing



.22

€ 30,00 - S

### Rubinetto arresto quadro uscita 3/8"

Concealed stop valve square 1/2" with connection 3/8" / Robinet d'arrêt carré 1/2" sortie 3/8" / Unterputzstopventil quadratisch 1/2" Anschluß 3/8"

**54209.29**

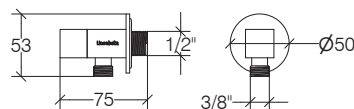
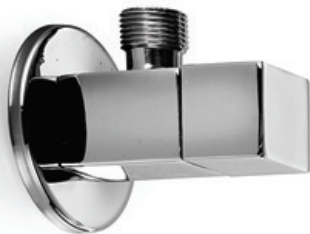

Ottone cromato  
Chromed brass  
Laiton chromé  
Verchromtes Messing



.29

€ 30,00 - S

**Canole**

**Miscelatore monocomando lavabo**

Single lever washbasin mixer / Mitigeur monotrou pour lavabo / Einhebel Mischer für Waschtisch

**6302.nn**

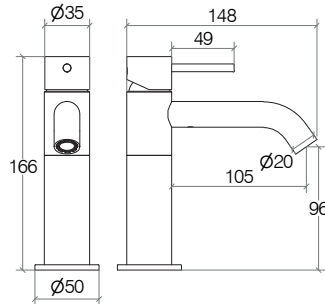

**Acciaio inox lucido**  
Polished stainless steel  
Acier inoxydable brillant  
Poliert Edelstahl



.29

€ 276,00 - M

**Acciaio inox satinato**  
Satinated stainless steel  
Acier inoxydable satiné  
Vereist Edelstahl



.32

€ 253,00 - M



**Miscelatore monocomando lavabo alto**

High single lever washbasin mixer / Mitigeur monotrou haut pour lavabo / Höher Einhebel Mischer für Waschtisch

**6304.nn**

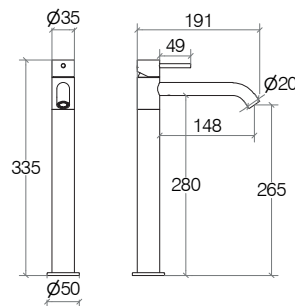

**Acciaio inox lucido**  
Polished stainless steel  
Acier inoxydable brillant  
Poliert Edelstahl



.29

€ 353,00 - M

**Acciaio inox satinato**  
Satinated stainless steel  
Acier inoxydable satiné  
Vereist Edelstahl



.32

€ 320,00 - M



**Miscelatore monocomando bidet**

Single lever bidet mixer / Mitigeur monotrou pour bidet / Einhebel Bidetmischer

**6206.nn**

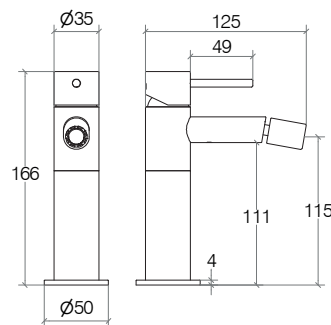

**Acciaio inox lucido**  
Polished stainless steel  
Acier inoxydable brillant  
Poliert Edelstahl



.29

€ 287,00 - M

**Acciaio inox satinato**  
Satinated stainless steel  
Acier inoxydable satiné  
Vereist Edelstahl



.32

€ 265,00 - M



## Canole

### Miscelatore incasso dev. 2 vie

6316.nn

Built-in mixer with diverter, 2 exits / Mitigeur à encastrer avec déviateur 2 sorties / Einhebel Mischer Unterputz mit 2 Umsteller

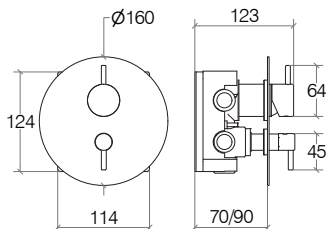

**Acciaio inox lucido**  
Polished stainless steel  
Acier inoxydable brillant  
Poliert Edelstahl

**Acciaio inox satinato**  
Satinated stainless steel  
Acier inoxydable satiné  
Vereist Edelstahl



.29

€ 419,00 - M



.32

€ 386,00 - M



### Miscelatore a muro 2 fori con canna

6325.nn

Built-in mixer with spout and 2 holes / Mitigeur à encastrer avec bec, 2 trous / Einhebel Mischer Unterputz mit Wanneneinlauf 2 Löcher

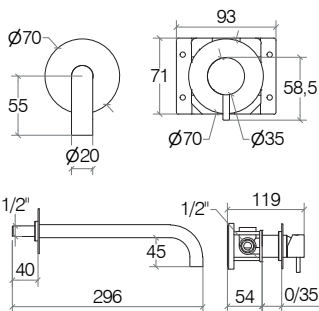

**Acciaio inox lucido**  
Polished stainless steel  
Acier inoxydable brillant  
Poliert Edelstahl

**Acciaio inox satinato**  
Satinated stainless steel  
Acier inoxydable satiné  
Vereist Edelstahl



.29

€ 430,00 - M



.32

€ 397,00 - M



## Ricambi / Spare parts / Pièces détachées / Ersatzteile

<b>5392</b>	R2553924	Rosone a muro Ø 65 - Wall rosette Ø 65	<b>5,00</b>
	R2553901	Tubo uscita per sifone 400 mm - Exit tube for siphon 400 mm	<b>12,00</b>
	R2553902	Tubo orlato entrata per sifoni 400 mm - Edged tube for siphon 400 mm	<b>12,00</b>
	R22539222	Guarnizione D.40 mm - Gasket D.40 mm	<b>2,00</b>
<b>53921</b>	R25539212	Tubo ad angolo - Corner tube	<b>12,00</b>
	R2553924	Rosone a muro Ø 65 - Wall rosette Ø 65	<b>5,00</b>
	R2553892	Angolo ghiera girevole - Rotating grid angle	<b>23,00</b>
	R2553901	Tubo uscita per sifone 400 mm - Exit tube for siphon 400 mm	<b>12,00</b>
<b>53922</b>	R2553924	Rosone a muro Ø 65 - Wall rosette Ø 65	<b>5,00</b>
	R2553901	Tubo uscita per sifone 400 mm - Exit tube for siphon 400 mm	<b>12,00</b>
	R2553902	Tubo orlato entrata per sifoni 400 mm - Edged tube for siphon 400 mm	<b>12,00</b>
	R22539221	Bottiglia plastica interna sifone 53922 - Internal plastic bottle siph.53922	<b>4,00</b>
	R22539222	Guarnizione D.40 mm - Gasket D.40 mm	<b>2,00</b>
	R25539223	Ghiera superiore sifone 53922 - Upper grid for siphon 53922	<b>10,00</b>
<b>53925</b>	R2553924	Rosone a muro Ø 65 - Wall rosette Ø 65	<b>5,00</b>
	R2553901	Tubo uscita per sifone 400 mm - Exit tube for siphon 400 mm	<b>12,00</b>
	R2553902	Tubo orlato entrata per sifoni 400 mm - Edged tube for siphon 400 mm	<b>12,00</b>
	R22539221	Bottiglia plastica interna sifone 53922 - Internal plastic bottle siph.53922	<b>4,00</b>
	R22539222	Guarnizione D.40 mm - Gasket D.40 mm	<b>2,00</b>
<b>53926</b>	R2553924	Rosone a muro Ø 65 - Wall rosette Ø 65	<b>5,00</b>
	R2553901	Tubo uscita per sifone 400 mm - Exit tube for siphon 400 mm	<b>12,00</b>
	R2553902	Tubo orlato entrata per sifoni 400 mm - Edged tube for siphon 400 mm	<b>12,00</b>
	R22539221	Bottiglia plastica interna sifone 53922 - Internal plastic bottle siph.53922	<b>6,00</b>
	R22539222	Guarnizione D.40 mm - Gasket D.40 mm	<b>2,00</b>
<b>53927</b>	R25539212	Tubo ad angolo - Corner tube	<b>12,00</b>
	R2553924	Rosone a muro Ø 65 - Wall rosette Ø 65	<b>5,00</b>
	R25539271	Gomito per sifone - Siphon angle pipe	<b>36,00</b>
	R25539272	Bottiglia plastica interna sifone 53927 Internal plastic bottle siph.53927	<b>5,00</b>



**Ricambi / Spare parts / Pièces détachées / Ersatzteile**

<b>53961</b>	R25539612	Tappo piletta - Waste water drain hole plug	<b>9,00</b>
	R25539611	Meccanismo per piletta - Automatic waste water drain mechanism	<b>10,00</b>
	R2253971	Guarnizione inferiore piletta gomma trasparente Lower waste water drain transparent rubber o'ring	<b>3,00</b>
	R2253992	Guarnizione tappo piletta click nera - Automatic waste water drain black o'ring	<b>3,00</b>
	R2253972	Guarnizione superiore piletta in spugna - Upper waste water drain sponge o'ring	<b>3,00</b>
	R2453961222	Tappo piletta nero - Black water drain cover	<b>10,00</b>
<b>53972</b>	R2553976	Tappo piletta scarico libero Free waste water drain cover	<b>9,00</b>
	R2253971	Guarnizione inferiore piletta gomma trasparente Lower waste water drain transparent rubber o'ring	<b>3,00</b>
	R2253972	Guarnizione superiore piletta in spugna Upper waste water drain sponge o'ring	<b>3,00</b>
<b>53975</b>	R2553976	Tappo piletta scarico libero Free waste water drain cover	<b>9,00</b>
	R2253971	Guarnizione inferiore piletta gomma trasparente Lower waste water drain transparent rubber o'ring	<b>3,00</b>
	R2253972	Guarnizione superiore piletta in spugna Upper waste water drain sponge o'ring	<b>3,00</b>
<b>53991</b>	R2553997	Tappo piletta klik clak - Automatic waste water drain cover	<b>9,00</b>
	R2553998	Meccanismo per piletta klik clak Automatic waste water drain mechanism	<b>10,00</b>
	R2253971	Guarnizione inferiore piletta gomma trasparente Lower waste water drain transparent rubber o'ring	<b>3,00</b>
	R2253972	Guarnizione superiore piletta in spugna Upper waste water drain sponge o'ring	<b>3,00</b>
	R2253992	Guarnizione tappo piletta click nera Automatic waste water drain black o'ring	<b>3,00</b>
	R245399722	Tappo piletta nero - Black water drain cover	<b>10,00</b>
<b>53992</b>	R2553997	Tappo piletta klik clak - Automatic waste water drain cover	<b>9,00</b>
	R2553998	Meccanismo per piletta klik clak Automatic waste water drain mechanism	<b>10,00</b>
	R2253971	Guarnizione inferiore piletta gomma trasparente Lower waste water drain transparent rubber o'ring	<b>3,00</b>
	R2253972	Guarnizione superiore piletta in spugna Upper waste water drain sponge o'ring	<b>3,00</b>
	R2253992	Guarnizione tappo piletta click nera Automatic waste water drain black o'ring	<b>3,00</b>
<b>53994</b>	R2553997	Tappo piletta klik clak - Automatic waste water drain cover	<b>9,00</b>
	R2553998	Meccanismo per piletta klik clak - Automatic waste water drain mechanism	<b>10,00</b>
	R2253971	Guarnizione inferiore piletta gomma trasparente Lower waste water drain transparent rubber o'ring	<b>3,00</b>
	R2253972	Guarnizione superiore piletta in spugna Upper waste water drain sponge o'ring	<b>3,00</b>
	R2253992	Guarnizione tappo piletta click nera Automatic waste water drain black o'ring	<b>3,00</b>



**Ricambi / Spare parts / Pièces détachées / Ersatzteile**

<b>53995</b>	R2553997	Tappo piletta clik clak - Automatic waste water drain cover	<b>9,00</b>
	R2553998	Meccanismo per piletta clik clak - Automatic waste water drain mechanism	<b>10,00</b>
	R2253971	Guarnizione inferiore piletta gomma trasparente Lower waste water drain transparent rubber o'ring	<b>3,00</b>
	R2253972	Guarnizione superiore piletta in spugna - Upper waste water drain sponge o'ring	<b>3,00</b>
	R2253992	Guarnizione tappo piletta click nera + Automatic waste water drain black o'ring	<b>3,00</b>
<b>54198</b>	R25542081	Placca a muro tonda per rubinetto - Round faucet wall plate	<b>10,00</b>
<b>54199</b>	R25542081	Placca a muro tonda per rubinetto - Round faucet wall plate	<b>10,00</b>
<b>54208</b>	R25542081	Placca a muro tonda per rubinetto - Round faucet wall plate	<b>10,00</b>
<b>54203</b>	R25542081	Placca a muro tonda per rubinetto - Round faucet wall plate	<b>10,00</b>
<b>54204</b>	R25542081	Placca a muro tonda per rubinetto - Round faucet wall plate	<b>10,00</b>
<b>54209</b>	R25542081	Placca a muro tonda per rubinetto - Round faucet wall plate	<b>10,00</b>
<b>6302</b>	R226202	Cartuccia miscelatore - Mixer cartridge	<b>69,00</b>
	R2262021	Aeratore per miscelatore - Mixer aerator	<b>5,00</b>
<b>6304</b>	R226202	Cartuccia miscelatore - Mixer cartridge	<b>69,00</b>
	R2262021	Aeratore per miscelatore - Mixer aerator	<b>5,00</b>
<b>6306</b>	R226202	Cartuccia miscelatore - Mixer cartridge	<b>69,00</b>
	R2262021	Aeratore per miscelatore - Mixer aerator	<b>5,00</b>
<b>6308</b>	R226202	Cartuccia miscelatore - Mixer cartridge	<b>69,00</b>
	R2262021	Aeratore per miscelatore - Mixer aerator	<b>5,00</b>

## **Italia**

**1)** I prezzi del listino sono espressi in euro, IVA esclusa, non sono impegnativi e si intendono per merce resa franco stabilimento di Gambellara (Vicenza) Italia.

**2)** L'importo minimo degli ordini con consegna prevista dalla sede di Gambellara è di 300,00 Euro imponibili.

Ordini di importo inferiore a 300,00 Euro imponibili, saranno gravati di un addebito di 25,00 Euro netti per spese forfettarie di gestione ordine e trasporto.

**3)** In caso di insoluti verranno bloccate tutte le spedizioni e tutti gli ordini in corso verranno automaticamente sospesi: al momento del pagamento/sblocco dell'insoluto, i tempi di consegna degli ordini saranno ricalcolati secondo i termini di consegna previsti o concordati, partendo dalla data di sblocco.

**4)** Il destinatario è obbligato a controllare la merce in arrivo e a contestare subito gli eventuali danni direttamente al trasportatore, che ne è responsabile.

È diritto del destinatario e dovere del trasportatore controllare la spedizione (senza aprire l'imballo) e apporre le eventuali riserve specifiche sul DDT del trasportatore e quello Lineabeta srl. La sola dicitura generica: "RISERVA DI CONTROLLO" non è valida.

**5)** Danno occulto: nel caso di colli rovinati solo esternamente, questi possono essere ritirati indicando sui DDT (documento di trasporto) del trasportatore e di Lineabeta srl la clausola "RISERVA CONTROLLO", specificando la motivazione per cui si è posta la riserva, come previsto dal regolamento (DPR 450 2/8/85) vigente. Nel caso di rotture accertate, il destinatario deve darne comunicazione scritta a mezzo raccomandata a Lineabeta srl e per conoscenza al trasportatore spedendola entro e non oltre 8 giorni dal ricevimento merce.

**6)** Danno accertabile: nel caso di danno evidente ed accertabile anche dal trasportatore, deve essere posta una riserva sul DDT del trasportatore e di Lineabeta srl, indicando chiaramente quantità e codici danneggiati ed il tipo di danno esterno ed interno riscontrato.

Copia dei DDT dovrà essere inviata all'ufficio clienti Lineabeta srl, che successivamente darà le opportune disposizioni per l'eventuale gestione di sostituzione e di reso del materiale.

**7)** Qualora i danni occulti o accertabili siano gestiti diversamente da quanto previsto ai paragrafi 6 e 7, Lineabeta srl non riconoscerà alcun rimborso per danni o rotture riscontrate.

**8)** Nessun articolo può essere reso senza l'autorizzazione scritta da Lineabeta srl: i resi preventivamente autorizzati dovranno pervenire in porto franco al nostro stabilimento, utilizzando il trasportatore ed il numero di riferimento comunicati da Lineabeta srl. Il numero di riferimento deve essere riportato sul documento di trasporto.

Se nell'accurato controllo Lineabeta srl riscontrasse incurie dell'acquirente, il materiale reso sarà gravato di un importo per la copertura delle spese generali oltre ad eventuali spese di ripristino a nuovo.

**9a)** Gli ordini sono soggetti all'approvazione di Lineabeta srl.

Nessun ordine potrà essere annullato o modificato senza il consenso di Lineabeta srl, che si riserva la facoltà di addebitare eventuali oneri e spese che ne derivano.

La conferma dell'avvenuto annullamento o modifica, come anche dell'importo addebitato, sarà effettuata unicamente da Lineabeta srl, in forma scritta.

**9b)** Una volta ricevuta l'autorizzazione al reso, il cliente-mittente dovrà rendere il materiale disponibile ed imballato idoneamente per il trasporto alla data di ritiro concordata e indicata nell'autorizzazione.

In caso contrario, Lineabeta srl si riserverà la facoltà di addebitare al cliente-mittente i costi di competenza conseguenti al mancato ritiro.

### **TERMINI DI CONSEGNA**

**10)** La data di consegna dei prodotti è sempre indicativa e non vincolante, salvo diversamente pattuito per iscritto.

La disponibilità immediata dei prodotti a magazzino può anche essere richiesta inviando una e-mail all'indirizzo: [commerciale1@lineabeta.com](mailto:commerciale1@lineabeta.com)

**11)** I termini fissati per la spedizione non sono tassativi e in nessun caso possono costituire pretesto per ritardati pagamenti o richieste di risarcimento danni. Gli ordini possono essere anche evasi parzialmente.

**12)** In caso di particolari esigenze logistiche/operative, è possibile richiedere consegne e spedizioni personalizzate (pallettizzate, master box, riferimenti etc.) specificandolo nell'ordine e contattando direttamente il servizio clienti della propria area, in modo da concordare tipologia, tempistiche ed eventuale maggiorazione per spese di trasporto e/o per spese di realizzo imballo.

**13)** Le spedizioni vengono eseguite con il mezzo giudicato più idoneo da Lineabeta srl e la merce viaggia a rischio e pericolo del committente, anche se spedita, per speciali accordi, franco destino.

**14)** I prodotti non a catalogo e/o fabbricati su specifica richiesta del committente non possono essere restituiti.

**PREZZI E PAGAMENTI**

- 15)** I prezzi di questo listino non sono contrattuali: gli ordini vengono accettati a prezzi e condizioni in vigore alla data di spedizione.
- 16)** L'imballo normale è gratuito. Eventuali imballi rinforzati saranno addebitati al costo.
- 17)** I pagamenti dovranno essere effettuati puntualmente al domicilio di Gambellara e secondo le condizioni stabilite: qualsiasi contestazione non darà diritto all'acquirente di trattenere somme dovute per fatture in essere e/o scadute.
- 18)** Per fatture di importo inferiore a 300,00 Euro di imponibile, Lineabeta srl si riserva la facoltà di modificare le condizioni di pagamento.
- 19)** In mancanza di speciali pattuizioni il pagamento si intende alla consegna.
- 20)** I termini di pagamento dovranno essere tassativamente osservati. Sui ritardati pagamenti decorreranno gli interessi legali aggiornati al momento (DL 9/10/2002 n° 231), salvo il diritto di Lineabeta srl di sospendere o annullare ogni altra consegna senza pregiudizio di ogni altra azione o diritto.
- 21)** I prodotti forniti rimangono di proprietà di Lineabeta srl fino ad integrale pagamento del prezzo, come previsto dal C.C. art. 1523 e segg.

**GARANZIE**

**22)** Lineabeta srl garantisce i propri prodotti per 24 mesi a decorrere dalla data d'acquisto e comunque entro i limiti del DPR 224/05/88 e secondo le direttive Europee.

La garanzia copre esclusivamente vizi e difetti di fabbricazione o assemblaggio.

Difetti estetici o strutturali devono essere comunicati per iscritto a Lineabeta srl solo ed esclusivamente prima dell'installazione, allegando i documenti di acquisto e di prodotto.

**23)** La garanzia impegna Lineabeta srl solo alla riparazione e/o alla sostituzione degli elementi difettosi: sono pertanto escluse ulteriori pretese da parte dell'acquirente, ed è escluso qualsiasi indennizzo derivato dal disagio, od onere o costo relativo accessorio. La non conformità dovrà essere riconosciuta solo da parte di personale autorizzato da Lineabeta srl.

**24)** Sono comunque esclusi dalla garanzia i seguenti casi:

- Se il difetto è riconducibile al trasporto.
- Rotture di tutte le parti in vetro, ceramica o altro materiale fragile, causate da impatto, urti durante il trasporto, movimentazione manuale degli elementi in fase di installazione e impatti accidentali durante l'utilizzo.
- Se l'installazione non è stata eseguita dettagliatamente secondo istruzioni di Lineabeta srl.
- Se il vizio di funzionamento è conseguente ad un intervento non autorizzato sul prodotto.
- Se il funzionamento difettoso è conseguente alla normale usura del prodotto, alla negligenza o incuranza da parte dell'acquirente nel rispetto delle indicazioni di uso e manutenzione allegate al prodotto.
- Se il difetto è riconducibile all'utilizzo di detersivi abrasivi, a base acida, o prodotti non adatti alla pulizia di superfici cromate, laccate, verniciate, anodizzate e vetrose.
- Se il funzionamento difettoso è conseguente a forze maggiori.
- Se vi è stata una manomissione del prodotto da parte dell'acquirente.

**MISCELLANEA**

**25)** Lineabeta srl declina qualsiasi responsabilità per eventuali danni a persone, animali o cose causati da errori di installazione, di regolazione, imperfetto utilizzo o la mancata osservanza di tutte le prescrizioni indicate nella documentazione allegata al prodotto.

**26)** Lineabeta srl si riserva il diritto di apportare, senza preavviso e in qualsiasi momento, modifiche tecniche ed estetiche ai propri prodotti, ivi comprese modifiche a volume e peso.

**27)** Ogni eventuale pattuizione che possa derogare, in tutto o in parte, alle presenti condizioni generali, deve risultare da espresso accordo scritto.

**28)** Il presente listino prezzi annulla tutti i precedenti ed è valido a far data dal 01/03/2020.

**29)** Per ogni controversia è competente unicamente il Foro di VICENZA - ITALIA.

**30)** Ai sensi della legge DL 196/2003 Lineabeta srl dichiara che i dati messi a disposizione dal committente verranno elaborati in rispetto della legge sulla tutela della privacy.

**31)** Tutte le suddette condizioni di vendita si intendono integralmente accettate con il conferimento dell'ordine.

**ENG**

- 1)** The prices published on the present price list are in Euro, VAT excluded. The prices are not binding and the goods are delivered EX WORKS Lineabeta srl in Gambellara (VI) Italy.
- 2)** If the products are transported by Lineabeta srl or any forwarder to the client destination, the transport cost will be debited on the invoice.
- 3)** The minimum order amount is 300,00 Euro net. For orders lower than 300,00 Euro net, an additional charge of 25,00 Euro (net) will be charged for order management.
- 4)** In case of non-payment, shipments will be stopped and orders in progress will be suspended. Upon receipt of payment, a new delivery date will be given, by written.
- 5)** In case of the agreed credit line exceeding, orders will be anyway accepted by Lineabeta srl, but shipments will be stopped until the credit line is recovered.
- 6)** Deliveries have to be immediately inspected at destination arrival: in case of wrong items, and/or shortages, and/or any defect, and in case of transport damage, they have to be claimed to the forwarder, who's the sole responsible. It is right of the receiver and duty of the forwarder to control the delivery (without opening the package), writing a formal specific notification on the delivery notes. A generic written specification "subject to inspection" is not sufficient.
- 7)** Hidden damage: if on delivery, the goods display visible packaging defects, they can be withdrawn, but the receiver is obliged to note the defects on the PoD marking them as follows: "SUBJECT TO INSPECTION" and specifying the reason why, as per European regulations in use. In case of proven breakages, the receiver must inform by written both Lineabeta srl and forwarder within 7 days from the reception of the goods.
- 8)** Verified damage: any evident damage verified by receiver and forwarder must be duly marked on PoD, indicating very clearly quantity and damaged products codes, specifying if damage is occurred on the internal or external side. A further copy of PoD must be sent to Lineabeta srl customer service, which will consequently arrange the replacement upon reception of the damaged goods.
- 9)** Unlike what is clearly specified on the paragraphs 7 and 8, Lineabeta srl will not recognise any refund.
- 10)** Any return of goods has to be previously authorized by written by Lineabeta srl. Lineabeta srl will assign a reference number to the authorization, which will have to be reported on the PoD. Goods have to be sent to our warehouse perfectly packaged and free of charge. After Lineabeta srl control and in case of verified purchaser's neglect, the returned goods will be charged with an amount to recover general expenses and any possible restoration costs.
- 11)** Orders must be approved by Lineabeta srl. The only way to cancel orders already processed, is to ask for Lineabeta srl authorization. Lineabeta srl will reserve the right to charge any expenses caused by such cancellation.
- 12)** Orders are intended as per commercial conditions in use at the moment of order acceptance.
- 13)** Lineabeta srl reserves the right to change the payment terms for orders below 300,00 Euro.
- 14)** Normal packaging is free; any extra cost for reinforced packaging will be charged.

**DELIVERY TERMS:**

- 15)** Date of delivery is estimated and not binding, and orders may be partially processed. The immediate product availability can be requested by sending an e-mail to the internet address: sales@lineabeta.com
- 16)** Shipping terms are not fix and in no case constitute an excuse for payment delays and/or damages complains compensation.
- 17)** It is possible to require personalized deliveries and/or transports (pallets, iron baskets, with direct line, etc...) by sending an e-mail to Lineabeta srl adress sales@lineabeta.com, indicating type and terms, and accepting any eventual extra charge.
- 18)** The goods travel always at the consignee's risk, even in case of agreed "free delivery".
- 19)** Any return of special or out of catalogue products are not allowed.

**PRICES AND PAYMENTS:**

- 20)** The current price list invalidate and substitute all previous ones.
- 21)** Prices indicated in this price list can be changed: the orders will be accepted with prices and terms valid at the date of order.
- 22)** Payments shall be made by bank transfer and accordingly to specific commercial conditions in use. Any dispute will not give the buyer the right to deduct any amount from the due invoices.
- 23)** Unless otherwise agreed, the payments shall be made in advance.
- 24)** The agreed payment terms shall be strictly observed. In case of payment delay, Lineabeta srl has the right to suspend deliveries and to charge the customer with interests as per valid Italian and European regulations, giving to Lineabeta srl the full right to suspend any kind of delivery without any prejudice and any other kind of action or right.
- 25)** In accordance with Italian and European regulations, the supplied products remain of Lineabeta srl property until full payment is received.

**WARRANTY**

**26)** Lineabeta srl guarantees its products for 24 months from the date of delivery, according to the European regulations. The warranty exclusively covers manufacturing irregularities or material defects.

Aesthetic or functional defects must be communicated in writing to Lineabeta srl only and exclusively before installation, enclosing purchase and product documents reference.

**27)** Lineabeta srl warranty will be exclusively valid for the repair or the replacement of defective elements: no other purchaser claim shall be considered, absolutely excluding any derived discomfort, burden or accessory cost.

Any claimed non-compliance must be recognised and authorized by Lineabeta srl technical staff.

**28)** Samo Spa warranty lapses automatically in following cases:

- If defect refers to transport;
- In case of glass, ceramic, porcelain breaks due to transport, installation, use impacts.
- If installation isn't performed following strictly Lineabeta srl instructions;
- If defective functioning is due to unauthorized technical intervention on the product;
- If defective functioning is due to the normal product usury, or to the purchaser negligence or carelessness in following product maintenance indications;
- If defect is due to the use of acid based or abrasive detergents, or cleaning products not suitable for glass, chromed, lacque red or varnished surfaces.
- If defective functioning is due to a "force majeure" reason;
- In case of purchaser manumission of the product.

**29)** The products are intended solely for the purposes expressly indicated. Any use that differs from the purpose for which the products were designed are therefore forbidden. Lineabeta srl declines any responsibility for possible people, animals or goods damage due to installation or adjustments errors, imperfect use or no observance of all prescriptions indicated in product enclosed documents.

**30)** Lineabeta srl reserves the full right to technically and aesthetically modify the product at anytime and without previous notice, including changes in volume and weight.

**MISCELLANEOUS**

**30)** The products are intended solely for the purposes expressly indicated. Any use that differs from the purpose for which the products were designed are therefore forbidden. Lineabeta srl declines any responsibility for possible people, animals or goods damage due to installation or adjustments errors, imperfect use or no observance of all prescriptions indicated in product enclosed documents.

**31)** Lineabeta srl reserves the full right to technically and aesthetically modify the product at anytime and without previous notice, including changes in volume and weight.

**32)** Any possible agreement variation between Lineabeta srl and the customer, which totally or partially change the general sales condition, has to result by written.

**33)** For any dispute, the only competent jurisdiction is the Court of Vicenza-Italy.

**34)** As per the valid European regulations, Lineabeta srl declares that the information made available by the client will be processed according to privacy protection Law.

**35)** All the above-mentioned sales terms and conditions are intended as fully accepted by order confirmation.

## CONDITIONS GENERALES DE VENTE ET DE TRANSPORT

### FRA

**1)** Les prix HT indiqués en Euro dans ce tarif sont donnés sans engagement de durée et s'entendent pour marchandises départ dépôt Lineabeta srl Gambellara (Vicenza - Italie), TVA non comprise.

**2)** Si les marchandises sont transportées par Lineabeta srl ou par transitaire au client, les frais de transport seront débités sur facture.

**3)** Le montant minimum des commandes avec livraison prévue depuis le siège de Gambellara est de 300 Euros nets. La marchandise d'une valeur inférieure à 300 Euros nets expédiée en Franco de port sera objet d'un débit en facture de 25,00 Euro nets au titre de participation aux frais de gestion de commandes.

**4)** Le défaut de paiement d'une seule échéance rend toutes les autres immédiatement exigibles et Lineabeta srl se réserve le droit de suspendre ou d'annuler les commandes en cours, sans préjudice de tout autre recours.

**5)** En cas de défaut de règlement, les expéditions seront bloquées et les commandes en cours seront suspendues. Lorsque le règlement interviendra, le délai des commandes en cours sera recalculé, selon les termes de livraison habituels.

**6)** En cas de dépassement du crédit en cours maximum accordé, les commandes devront toujours être acceptées par Lineabeta srl. Par contre, les expéditions seront suspendues jusqu'au règlement d'au moins le montant nécessaire pour atteindre à nouveau le crédit en cours maximum accordé.

**7)** Au cours de l'exécution d'un marché, avant ou pendant les livraisons, nous nous réservons le droit de réclamer de l'acheteur caution bonne et solvable du prix des fournitures faites ou à faire et, en cas de refus, de résilier le marché.

Toute contestation concernant la facturation devra être formulée par écrit et dans les quinze jours de la réception de la facture par le client, sous peine d'irrecevabilité.

**8)** Il incombe au destinataire de vérifier l'état des marchandises à l'arrivée, en présence du livreur.

Le destinataire doit, par conséquent, ouvrir et vérifier la marchandise à la livraison devant le transporteur.

**9)** En cas de casse ou d'avarie, le destinataire doit impérativement le noter sur le récépissé de transport et sur le bon de livraison, et refuser le ou les colis cassés ou abîmés. En cas de colis manquant, le destinataire doit l'indiquer sur le récépissé de transport et sur le bon de livraison.

Exemple de réserves admises «refusé car colis cassé», «refusé car produit abîmé», «manque 1 colis».

Attention, la mention «sous réserve de déballage» ne pourra en aucun cas être prise en compte en cas de litige car elle n'est pas admise par les tribunaux.

**10)** En absence de réserves expressément prévues sur le récépissé de transport et sur le bon de livraison, notre responsabilité ne pourra en aucun cas être engagée et toute réclamation ne pourra être prise en compte et donner lieu à une substitution gratuite du produit.

**11a)** Les commandes sont sujettes à acceptation de Lineabeta srl.

Aucune commande déjà traitée pourra être annulée ou modifiée sans le consentement de Lineabeta srl, qui se réserve le droit de facturer les éventuels frais inhérents.

La confirmation de l'acceptation de modifications ou annulations et la facturation d'éventuels frais supplémentaires, sera confirmée par Lineabeta srl uniquement par écrit.

**11b)** En cas d'acceptation écrite par Lineabeta srl de retour de marchandises, le client-expéditeur devra mettre à disposition le matériel autorisé en retour à la date de retrait indiquée sur l'autorisation de retour, correctement emballé au fin du transport.

Dans le cas contraire, Lineabeta srl se réserve le droit de facturer au client-expéditeur les coûts engendrés par la présentation du transporteur.

**11c)** Les retours ne peut pas être effectuée sans l'accord de Lineabeta srl, qui se réserve la faculté de débiter les éventuels frais et charges qui en découleraient.

**12)** Les prix indiqués dans ce tarif ne sont pas contractuel: les commandes sont acceptées aux prix et aux conditions en vigueur au jour de l'expédition.

**13)** Pour les factures d'un montant inférieur à 300 euros, Lineabeta srl se réserve la faculté de modifier les conditions de paiement.

**14)** L'emballage normal est gratuit, les éventuels emballages renforcés seront facturés en supplément.

### TERMES DE LIVRAISON

**15)** La date de livraison des produits est indicative et n'a pas caractère obligatoire. La réponse relative à la disponibilité immédiate de la marchandise on peut l'obtenir en écrivant à : [sales@lineabeta.com](mailto:sales@lineabeta.com)

**16)** Les délais de fabrication, ainsi que les délais de transport sont donnés à titre purement indicatif et ne constituent, en aucun cas, un engagement de notre part.

Aussi, ils ne peuvent être pris comme prétexte pour des annulations de commande, des retards de paiement ou des demandes de dédommagement.

Les commandes pourront être exécutées même partiellement sans que cela puisse constituer une cause d'annulation.

**17)** Il est possible de demander des livraisons et des expéditions personnalisées (sur palette, sur chariot métallique, en direct, etc...) en envoyant un e-mail au service clients, en manière à définir le mode d'expédition, les délais de livraison et à obtenir un devis relativement aux frais de transport et/ou aux frais de préparation et de confection d'emballages spécifiques.

**18)** Les expéditions seront effectuées par les moyens que Lineabeta srl jugera les plus indiqués et la marchandise voyagera aux risques et périls du client, même si elle est expédiée en franco-destination selon des accords particuliers.

**19)** Les produits hors catalogue et/ou fabriqués selon une demande spécifique du client ne pourront en aucun cas faire l'objet d'une restitution.

**PRIX ET PAIEMENTS**

**20)** Les paiements doivent être effectués directement auprès de la société Lineabeta srl.

Pour les factures d'un montant inférieur à 300 Euros, Lineabeta srl se réserve la faculté de modifier les conditions de paiement

**21)** Sauf accord particulier les paiements s'effectuent à la livraison.

**22)** En cas de retard de paiement à l'échéance convenue, Lineabeta srl sans mise en demeure préalable, percevra des pénalités de retard égales au taux d'intérêt appliqué par la Banque Centrale Européenne (BCE) à son opération de refinancement la plus récente majorée de 10 % ainsi qu'une indemnité forfaitaire pour frais de recouvrement (Décret n°2012-1115 du 2 octobre 2012) calculées à partir de la date à laquelle le règlement aurait dû intervenir et sans préjudice des dépenses qui seraient à la charge du débiteur en cas d'action judiciaire. Si les frais de recouvrement s'avéraient supérieurs à 40 euros, Lineabeta srl se réservera le droit de demander sur justifications une indemnité complémentaire.

**23)** Nos marchandises sont vendues avec une clause subordonnant expressément le transfert de leur propriété au paiement intégral du prix en principal et accessoires.

Ne constitue pas paiement au sens de cette clause, la remise d'un titre créant une obligation de payer (traite ou autre).

En conséquence, les marchandises livrées restent notre propriété jusqu'à ce que le titre ait été effectivement payé.

Nous nous réservons le droit, à défaut de paiement d'une seule fraction du prix et quinze jours après mise en demeure restée infructueuse, de considérer la vente comme résiliée de plein droit, et d'obtenir restitution des marchandises livrées, avec ou sans ordonnance rendue en Italie, par le Président du Tribunal de Vicenza (Italie).

L'éventuelle reprise par le vendeur des marchandises vendues en réserve de propriété impose à l'acheteur l'obligation de réparer le préjudice résultant de la dépréciation et de l'indisponibilité des biens concernés.

Pour la FRANCE :Loi n° 80-335 du 12 mai 1980, loi du 10 juin 1994, Code du Commerce art. L-122, loi du 1er juillet 1996 ; Pour la BELGIQUE, est valable le même principe car prévu dans le Code Civil Italien.

**GARANTIE**

**24)** Lineabeta srl garantit ses propres produits pour une période de 24 mois à compter de la date d'achat, selon les dispositions du Code Civil Italien et des directives Européennes en la matière.

La garantie couvre exclusivement les vices et défauts de fabrication ou d'assemblage.

Les défauts d'ordre esthétique ou structurel doivent être communiqués par écrit à Lineabeta srl seulement et exclusivement avant l'installation, en y alléguant les documents d'achat et de produit.

**25)** La garantie engage Lineabeta srl exclusivement à la réparation et/ou au remplacement des éléments défectueux: sont cependant exclues les prétentions supplémentaires de la part de l'acquéreur, et exclus toute demande d'indemnisation dérivant de la gêne occasionnée, ou charge ou coût accessoire relatif.

La garantie ne couvre pas les frais de main-d'oeuvre et ceux résultant des opérations suivantes : démontage, remontage, transport sur site, etc....

La non conformité devra être identifiée et confirmée uniquement par du personnel autorisé par Lineabeta srl.

**26)** Sont cependant exclus de la garantie les cas suivants:

- si le défaut est dû au transport;
- casse des parties en verre;
- si l'installation n'a pas été effectuée scrupuleusement selon les instructions de Lineabeta srl ;
- si le vice de fonctionnement résulte d'une intervention sur le produit effectuée sans autorisation;
- si le fonctionnement défectueux provient de l'usure normale du produit, d'une négligence ou d'un défaut d'entretien de la part de l'acheteur eu égard aux indications alléguées au produit;
- si le défaut résulte de l'utilisation de détergents abrasifs, à base acide, ou de produits non adaptés à l'entretien de surfaces laquées, vernies, anodisées ou vitrées.
- si le fonctionnement défectueux résulte de la force majeure;
- altération, modification du produit du fait de l'acquéreur.

**27)** Lineabeta srl décline toute responsabilité pour d'éventuels dommages causés à des personnes, des animaux ou des objets et dus à des erreurs d'installation, de réglage, à une utilisation inappropriée ou à la carence d'observation des prescriptions indiquées dans la documentation alléguée au produit.

**28)** Photos non contractuelles. Sous réserve des écarts de couleurs liés aux techniques d'impression.

Lineabeta srl se réserve le droit d'apporter des modifications techniques et esthétiques à ses propres produits à tout moment et sans préavis, y compris les changements dans le volume et le poids

**29)** Toute éventuelle négociation qui viendrait déroger, en totalité ou en partie, à ces Conditions Générales de Vente devra expressément faire l'objet d'un accord écrit de la part de Lineabeta srl.

**30)** Cette liste de prix annule et remplace tous les précédents tarifs.

**31)** En cas de contestation, la compétence exclusive est donnée au Tribunal de Vicenza (Italie) et la Loi applicable est la Loi Italienne.

**32)** Lineabeta srl déclare que les informations mises à sa disposition seront utilisées en vertu des dispositions de la Directive Européenne en matière d'Informatique et de Liberté.

**33)** Les présentes Conditions Générales de Vente sont considérées comme acceptées par l'acheteur au moment de la commande.

- 1)** Die Preisliste ist in Euro ausgedrückt (ohne MwSt.). Die Preise sind nicht verbindlich und gelten für ab Werk Gambellara (Vicenza-Italien) gelieferte Ware.
- 2)** Wenn die Produkte von Lineabeta srl oder von einem Spediteur zum Bestimmungsort des Kunden geliefert sind, werden die Transportkosten in der Rechnung gestellt.
- 3)** Der Netto Mindestbestellwert für Ab Werk Lineabeta srl Gambellara (Vicenza-Italien) Bestellungen ist 300,00 €. Bei Bestellungen unter 300,00 Euro (ohne MwSt.), wird eine Bearbeitungsgebühr von 25,00 Euro erhoben.
- 4)** Im Fall von Zahlungsrückständen wird der Versand, sowie die laufenden Bestellungen, gestoppt: nach Zahlung der offenen Posten, werden die Bestellungen entsprechend der Lieferungszeiten vom Datum des Stopps aus wieder neu berechnet.
- 5)** Im Fall der Überziehung des vereinbarten Kreditlimits werden die Bestellungen von Lineabeta srl zwar angenommen: der Versand wird dagegen bis zur Zahlung eines ausreichenden Betrages zurückgehalten, um das vereinbarte Kreditlimit wieder zu erreichen.
- 6)** Der Empfänger ist verpflichtet, die Ware bei Eingang zu überprüfen und eventuelle Schäden sofort und direkt bei dem Frachtführer zu beanstanden, der hierfür verantwortlich ist.  
Es ist Recht des Empfängers und Pflicht des Frachtführers den Versand zu kontrollieren (ohne die Verpackung zu öffnen) und den eventuellen Vorbehalt im Frachtführer und Lineabeta srl Lieferschein daneben zu stellen: die allgemeine Aufschrift: "Kontrollvorbehalt" gilt leider nicht.
- 7)** Verdeckte Schäden: im Fall von äußerlich beschädigten Verpackungen, können diese entgegen genommen werden, wobei auf dem Lieferschein der Vermerk „KONTROLLVORBEHALT“ und die Begründung des Vorbehalts vermerkt werden muß, wie vom geltenden Gesetz vorgesehen.  
Bei eindeutigen ermittelten Bruchschäden muss der Empfänger durch Einschreibebrief an Lineabeta srl innerhalb von 8 Tagen nach Erhalt der Ware zusenden und, zur Kenntnisnahme, dem Frachtführer die entsprechende Mitteilung haben lassen.
- 8)** Sichtbarer Schaden: Im Fall von deutlich, feststellbaren Schäden muss auch vom Frachtführers ein Vorbehalt im Lieferschein vermerkt werden, in der die Menge, die beschädigten Teile, sowie innere oder äußere Schäden, klar zu bezeichnen sind. Kopien des Lieferscheins müssen an Lineabeta srl geschickt werden, mit Anzeige von Maßnahmen für den eventuellen Ersatz oder Warenrücksendung.
- 9)** Bei Nichtbeachtung der Paragraphen 9 und 10 erkennt Lineabeta srl keine Erstattung für Schaden an.
- 10)** Kein Artikel wird ohne vorherige schriftliche Zustimmung von Lineabeta srl zurückgenommen: genehmigte Rücknahmen müssen unserem Werk frachtfrei zugehen, mit Angabe des Frachtführers und der von Lineabeta srl mitgeteilt Bezugsnummer. Die Bezugsnummer soll im Lieferschein vermerkt werden.  
Für Annahme und Bearbeitung von Rücksendungen werden generell Rücksendungskosten in Rechnung gestellt, die sich nach dem Zustand der zurück gesendeten Ware richten.
- 11)** Die Bestellungen müssen von Lineabeta srl bestätigt sein.  
Keine Bestellung kann ohne Lineabeta srl Zustimmung annulliert werden, wobei Lineabeta srl sich vorbehält, eventuelle Kosten und Ausgaben, die sich hieraus ergeben sollten, in Rechnung zu stellen.
- 12)** Bestellungen bedürfen der Lineabeta srl Annahme.  
Die Stornierung oder Änderung von Bestellungen ist unzulässig, wenn nicht die Zustimmung von Lineabeta srl vorliegt. Lineabeta srl vorbehält sich das Recht, daraus entstehende Aufwendungen und Gebühren in Rechnung zu stellen.  
Die erfolgte Stornierung oder Änderung wird ebenso wie der belastete Betrag einzig von Lineabeta srl in schriftlicher Form bestätigt.
- 13)** Die Normalverpackung ist kostenlos, eventuelle verstärkte Verpackungen werden zum Selbstkostenpreis in Rechnung gestellt.

#### UNGEFÄHRE LIEFERZEITEN AB WERK:

- 14)** Lieferzeit von der Artikel ist nicht bindend. Der sofortige Lagerbestand kann durch Sendung einer e-mail an die Adresse: [verkauf@lineabeta.com](mailto:verkauf@lineabeta.com) angefragt werden.
- 15)** Die festgelegten Versandfristen sind nicht bindend und rechtfertigen in keinem Fall den Anspruch auf Zahlungsverzögerung oder Schadensersatz: die Aufträge können auch in Teillieferungen erledigt werden.
- 16)** Es ist möglich, spezielle Lieferungen und Versandbedingungen (in Paletten, auf Eisenkörbe, mit direkter Linie, usw.) zu erhalten. Senden Sie eine e-mail an die Adresse [verkauf@lineabeta.com](mailto:verkauf@lineabeta.com), um Art, Zeiten und eventuelle Zuschläge für Transport- und/oder Verpackungskosten zu erfahren.
- 17)** Der Warentransport geht auf Risiko und Gefahr des Auftraggebers, auch bei Versand nach Sonderabsprachen, frei Bestimmungsort.
- 18)** Produkte, die nicht im Katalog enthalten sind, oder die auf besonderen Wunsch des Auftraggebers angefertigt wurden, können nicht zurückgeschickt werden.



**PREISE UND ZAHLUNGEN**

- 19)** Die in dieser Preisliste angegebene Preise sind nicht verträglich: Bestellungen werden laut Preise und Bedingungen am Bestelldatum
- 20)** Die Zahlungen müssen zu den festgelegten Bedingungen an Lineabeta srl erfolgen: jegliche Beanstandung gibt dem Käufer nicht das Recht auf die Einbehaltung der für fällige Rechnungen ausstehenden Beträge.
- 21)** Wenn nicht anders vereinbart, gilt die Vorauskasse Zahlung.
- 22)** Die Zahlungsfristen sind strikt einzuhalten.
- 23)** Bei Rechnungen unter Euro 300,00 behält sich Lineabeta srl die Möglichkeit vor, die Zahlungsbedingungen zu ändern.
- 24)** Bei Zahlungsverzögerungen werden die jeweils geltenden Verzugszinsen in Anrechnung gebracht, vorbehaltlich des Rechts von Lineabeta srl, jegliche weitere Lieferung zu stoppen oder zu annullieren, unbeschadet des Rechts auf jede sonstige Maßnahme oder Anspruch.
- 25)** Die gelieferten Produkte bleiben bis zur vollständigen Bezahlung Eigentum von Lineabeta srl.

**GARANTIE**

**26)** Lineabeta srl garantiert für alle Produkte 24 Monate ab Lieferung, gemäß DPR 224 24/05/1988 (Italien) im Rahmen der europäischen Richtlinien.

Die Garantie deckt insbesondere Fabrikationsfehler und Materialdefekte ab.

Ästhetische oder funktionale Defekte müssen vor Installation schriftlich direkt an Lineabeta srl mitgeteilt werden, unter Beilage der Lieferdokumente und Produktdokumente.

**27)** Die Lineabeta srl Garantie gilt ausschließlich für die Reparatur oder den Ersatz der defekten Elemente: andere Forderungen oder Reklamationen der Erwerber werden nicht anerkannt, daraus abgeleitete Unannehmlichkeiten, Belastungen oder Nebenkosten werden ausdrücklich abgelehnt.

Die Übereinstimmung der Reklamation muss durch autorisiertes Personal von Lineabeta srl bestätigt werden.

**28)** Die Lineabeta srl Garantie erlöscht automatisch in folgenden Fällen:

- im Falle von Transportschäden;
- bei Bruch von zerbrechlich-Teilen (z.B. Glas, Keramik, Porzellan...) wegen zufällig Wirkung während Transport, Installation oder Benutzung;
- wenn die Montage nicht gemäß den Anleitungen von Lineabeta srl vorgenommen wurde;
- bei Auftreten eines technischen Defekts auf Grund von unbefugten technischen Veränderungen am Produkt;
- im Falle von üblichen Verschleißerscheinungen, sowie vom Benutzer unsachgemäßer und unvorsichtiger Behandlung des Produkts;
- bei Verwendung von säurehaltigen oder aggressiven Reinigungsmitteln oder Waschsubstanzen, die für Glas, eloxierte, lackierte oder verschönerte Oberflächen nicht geeignet sind.
- Defekte, die durch höhere Gewalt entstehen;
- wenn Erwerber das Produkt nicht bezahlt hat;

**VERSCHIEDENES**

**29)** Lineabeta srl lehnt jegliche Verantwortung für mögliche Personen- oder Sachschäden ab, die auf Grund von Installations- oder Montagefehlern, unsachgemäßen Gebrauch oder mangelhafte Wartung entstehen.

**30)** Lineabeta srl behält sich vor, jederzeit ohne jegliche Vorankündigung, technische oder design Änderungen an den eigenen Produkten vorzunehmen, einschließlich der Änderungen in Volumen und Gewicht.

**31)** Jegliche eventuelle Vereinbarung, die ganz oder teilweise von den vorliegenden allgemeinen Bedingungen abweichen kann, muss ausdrücklich schriftlich vereinbart werden.

**32)** Diese Preisliste ersetzt alle vorherigen Preislisten.

**33)** Für jegliche Streitfragen ist der Gerichtsstand von VICENZA - ITALIEN, oder ein anderes von Lineabeta srl bestimmtes entsprechend der Notwendigkeit gewähltes Gericht, zuständig.

**34)** In Übereinstimmung mit dem geltenden Gesetz erklärt Lineabeta srl, dass die vom Auftraggeber zur Verfügung gestellten Daten unter Haltung des Datenschutzgesetzes verarbeitet werden.

**35)** Die obengenannten Bedingungen gelten bei der Auftragserteilung als vollständig akzeptiert.

Special thanks to:

**Amarantostudio**

Art direction and Graphic concept, Marianna Porcellato e Antonio Visentin



**lineabeta®**  
EVERYDAY DESIGN

Lineabeta S.r.l.  
36053 Gambellara VI - Italy  
Strada Statale 11, Km 331  
T. +39 0444 644644  
F. +39 0444 644600  
info@lineabeta.com  
lineabeta.com

Lineabeta è un marchio di Samo Industries S.p.A.

**Samo**  
**industries**

LINEABETA S.r.l. - Ss 11, Km 331 36053 Gambellara VI (Italy) - Tel. +39 0444 644644 Fax +39 0444600 - info@lineabeta.com - www.lineabeta.com  
LINEABETA S.r.l. si riserva in esclusiva i diritti di modificare le dimensioni, caratteristiche tecniche, design dei suoi prodotti, senza nessun preavviso.  
Tutte le dimensioni sono indicative e potrebbero variare in conformità degli standard europei.

LINEABETA S.r.l. reserves the exclusive right to modify dimensions, technical characteristics and aesthetic design of its products, without prior notification.  
All dimensions are indicative and may vary to conform to european standards.

# Finiture / *Finishing / Finitions / Finishes*

Laminato / *Laminated / Stratifié / Holzlaminat*



**.01\_Olmo bianco** / *White elm tree / Orme blanc / Weiße Ulme*



**.02\_Olmo fumè** / *Smoke elm tree / Orme fumé / Rauch Ulme*

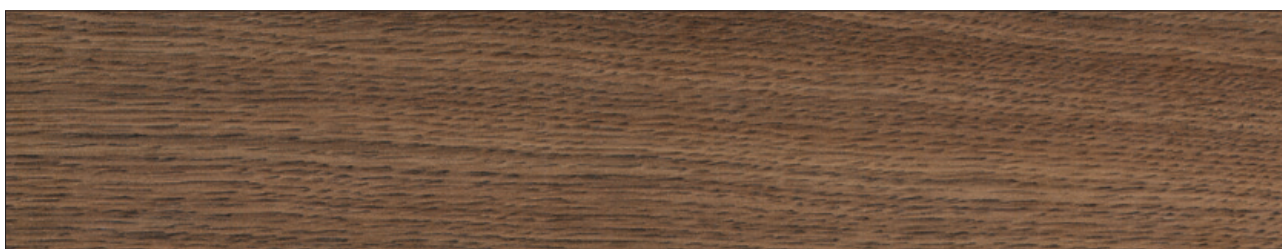

**.03\_Rovere castano** / *Brown Oak / Chêne brun / Braune Eiche*



**.05\_Rovere naturale** / *Natural Oak / Chêne naturel / Natürliche Eiche*

Legno / *Wood / Bois / Holz*



**.03\_Bambù naturale** / *Natural bamboo / Bambou naturel / Natürlicher Bambus*

Le tonalità colore dei campioni sono indicative  
*The printed colour's hue is by way of example only*  
*Sous réserve des écarts de couleurs liés à l'impression sur papier*  
*Die gedruckten Farbtöne sind lediglich richtungsweisend*

# Finiture / Finishing / Finitions / Finishes

## Laccato lucido / Glossy lacquered / Laqué brillant / Glänzend Lackiert

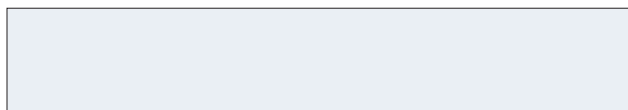

**.09L\_Bianco** / White / Blanc / Weiss



**.17L\_Antracite** / Anthracite / Anthracite / Anthrazit



**.21L\_Tortora** / Dove grey / Gris tourterelle / Taubengrau



**.22L\_Nero** / Black / Noir / Schwarz

## Laccato opaco / Matt lacquered / Laqué mat / Matt Lackiert

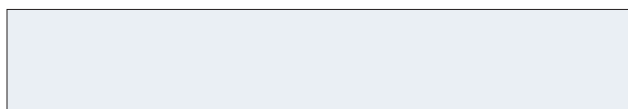

**.09\_Bianco** / White / Blanc / Weiss



**.17\_Antracite** / Anthracite / Anthracite / Anthrazit



**.21\_Tortora** / Dove grey / Gris tourterelle / Taubengrau



**.22\_Nero** / Black / Noir / Schwarz

## Metallo / Metal / Métal / Metall



**.09\_Bianco gofrato** / Goffering white  
Blanc gaufré / Geprägtes Weiß



**.17\_Antracite gofrato** / Goffering anthracite  
Anthracite gaufré / Geprägtes Anthrazit



**.18\_Nero gofrato** / Goffering black  
Noir gaufré / Geprägtes Schwarz



**.22\_Nero liscio** / Smooth black  
Noir lisse / Glatt Schwarz

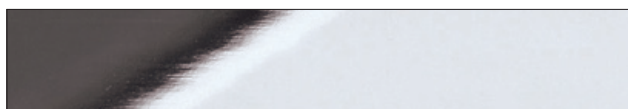

**.29\_Metallo cromo** / Chromed metal  
Métal chromé / Chrom Metall

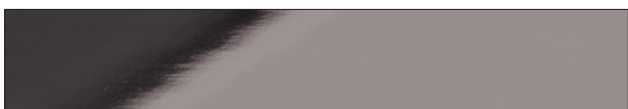

**.33\_Metallo nichel nero** / Black nickel colored metal  
Métal couleur nickel noir / Schwarz Nickel Metall



**.30\_Metallo oro** / Gold colored metal  
Métal couleur or / Gold Metall



**.35\_Metallo bronzo** / Bronze metal  
Métal couleur bronze / Bronze Metall

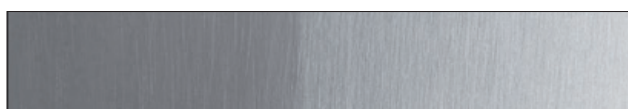

**.32\_Metallo satinato** / Satined metal  
Métal satiné / Vereist Metall

Le tonalità colore dei campioni sono indicative  
The printed colour's hue is by way of example only  
Sous réserve des écarts de couleurs liés à l'impression sur papier  
Die gedruckten Farbtöne sind lediglich richtungsweisend



lineabeta®  
EVERYDAY DESIGN

LBKLI S-20-MULTI29