

Divani, Divani Trasformabili e Poltrone.
Sofas, Convertible Sofas and Armchairs.
Sofas, Funktionssofas und Sessel.
Canapés, Canapés Convertibles et Fauteuils.



BONALDO

Divani. Sofas. Sofas. Canapés.

BONALDO

Bonaldo: Ottant'anni di storia

Bonaldo: Eighty years of history
Bonaldo: Achtzig Jahre Geschichte
Bonaldo: 80 ans d'histoire

En

This story began in 1936, when Giovanni Vittorio Bonaldo started up a craft-based metal working business. During the 1950s industrial production began on bedsteads, and it was extended during the '60s to iron beds. An extraordinary intuition led to the production of a folding bedstead, which went on to become a market standard, and which is still extraordinary today, considering its future implications.

The company subsequently specialised in the processing of tubular metal and invested in new machinery and technology, choices which allowed it to extend its range of products and to implement machining processes at the very cutting edge.

Today, Bonaldo designs, produces and distributes design-oriented tables, chairs, sofas, beds and interior furnishings for the Italian and the international market.

De

Diese Geschichte beginnt im Jahr 1936, als Giovanni Vittorio Bonaldo einen Handwerksbetrieb für die Metallverarbeitung eröffnet. In den Fünfzigerjahren beginnt er mit der industriellen Produktion von Lattenrosten, ab den Sechzigerjahren werden auch Metallbetten produziert. Herausragend wegen der Folgen für die Zukunft bleibt noch immer die Idee, einen klappbaren Lattenrost zu entwickeln, der später auf dem Markt zum Standard wurde.

Das Unternehmen spezialisierte sich in der Folge auf die Bearbeitung von Metallrohren und investierte in neue Maschinen und Technologien, eine Entscheidung, die die Möglichkeit bot, die Produktpalette zu erweitern und immer fortschrittlichere Verfahren anzuwenden.

Heute entwirft, produziert und vertreibt Bonaldo Tische, Stühle, Sofas, Betten und designorientierte Einrichtungsgegenstände für den italienischen und den internationalen Markt.

Fr

Une histoire qui commence en 1936, lorsque Giovanni Vittorio Bonaldo démarre une entreprise artisanale spécialisée dans la transformation des métaux. À partir des années cinquante l'entreprise se lance dans la production industrielle de sommiers à lattes et, dans les années soixante, de structures de lit en fer. L'intuition – extraordinaire à en juger par ses retombées futures – de réaliser un sommier pliant devient bientôt un standard sur le marché.

L'entreprise se spécialise par la suite dans la transformation de tubes métalliques et investit pour se doter de machines et de technologies nouvelles, autant de choix qui lui permettent d'élargir sa gamme de produits et de mettre en place des processus de plus en plus évolués.

Aujourd'hui, Bonaldo conçoit, fabrique et commercialise des tables, des chaises, des canapés, des lits et des compléments design-orientés pour le marché italien et international.

Questa storia inizia nel 1936, quando Giovanni Vittorio Bonaldo apre un'attività artigianale per la lavorazione dei metalli. A partire dagli anni Cinquanta inizia una produzione industriale di reti da letto, affiancata, negli anni Sessanta, a quella dei letti in ferro. Rimane straordinaria, per le sue implicazioni future, l'intuizione di realizzare una rete pieghevole, diventata poi uno standard di mercato.

L'azienda si specializza successivamente nella lavorazione di tubolari metallici e investe in nuovi macchinari e tecnologie, scelte che le consentono di ampliare la sua gamma di prodotti e di implementare processi sempre più evoluti. Oggi Bonaldo progetta, produce e distribuisce tavoli, sedie, divani, letti e complementi di design, per il mercato italiano e internazionale.

Evoluzione

Evolution / Entwicklung / Évolution

It Sono la dedizione e l'impegno di tre generazioni imprenditoriali che hanno permesso a Bonaldo di diventare un importante punto di riferimento nel settore dell'arredamento e del design. È il forte radicamento territoriale a permettere al marchio di far crescere, nei siti di Borgoricco e Villanova, vicino Padova, una squadra di maestranze che, in molti casi, si tramanda la capacità artigianale di padre in figlio.

De Die Hingabe und der Einsatz von drei Unternehmergenerationen machten aus Bonaldo einen wichtigen Bezugspunkt in der Möbel- und Designbranche. Durch die starke lokale Verwurzelung konnte das Unternehmen an den Standorten Borgoricco und Villanova, in der Nähe von Padua, eine Belegschaft aufbauen, die oft das handwerkliche Können vom Vater an den Sohn weitergibt.

En It is the dedication and commitment that have been passed down three generations of entrepreneurs that have enabled Bonaldo to become a major benchmark in the furniture and design industry. Bonaldo's strong ties to the local area have enabled the brand to grow and develop, in the Borgoricco and Villanova sites near Padua, a team of experts who, in many cases, have been craftsmen from one generation to the next.

Fr C'est la passion et l'engagement de trois générations d'entrepreneurs qui ont permis à Bonaldo de devenir une référence incontournable dans le secteur de l'ameublement et du design. Et c'est grâce à son enracinement territorial que la marque a pu développer, sur les sites de Borgoricco et Villanova près de Padoue, une équipe d'ouvriers qui transmettent souvent leurs capacités artisanales de père en fils.

Albino Bonaldo,
President



Ricerca e creazione

Research and creativity / Forschung und Kreativität / Recherche et création



Tecnologia, manualità e organizzazione.
Conoscenze tecniche e abilità manuali rappresentano i punti di riferimento di una struttura industriale moderna e competitiva che possiede una cultura dell'oggetto fatto secondo i canoni della migliore tradizione italiana.

Technology, manual skill and organization.
Technical knowledge and manual dexterity represent the reference points for a modern and competitive industrial organization that possesses a culture of products created in line with the best principles of Italian tradition.

Technologie, Handwerk und perfekte Organisation.
Technisches Know-how und handwerkliches Geschick bilden die Eckpfeiler eines modernen, wettbewerbsfähigen Industriebetriebs, der auf Designkultur nach bester italienischer Tradition setzt.

Technologie, habileté et organisation.
Les connaissances techniques et le savoir-faire manuel représentent les points forts d'une structure industrielle moderne et compétitive qui possède une culture de l'objet réalisé selon les critères de la plus belle tradition italienne.

IT È la capacità di rimanere ancorati al Made in Italy, laddove questo si concretizza in una coerente attenzione alla scelta dei materiali, alla lavorazione in loco di ogni singolo componente, ad un processo di controllo attento e rigoroso.

È, infine, il costante investimento in Ricerca e Sviluppo che permette a Bonaldo di realizzare prodotti capaci di soddisfare le esigenze e i gusti di un pubblico dinamico ed internazionale.

En Bonaldo's ability to remain true to the spirit of excellence Made in Italy can be seen in the painstaking care with which materials are selected, the on-site processing of every single component and a strict and careful control process.

Last but not least, ongoing investments in Research and Development have enabled the Bonaldo brand to manufacture products designed to accommodate the needs and tastes of a dynamic, international target.

De Das Unternehmen ist auch im „Made in Italy“ verankert, das bedeutet großes Augenmerk für die Auswahl der Materialien, die Bearbeitung jedes einzelnen Bestandteils vor Ort und strenge und gewissenhafte Qualitätskontrollen.

Durch die ständigen Investitionen in Forschung und Entwicklung ist Bonaldo schließlich in der Lage, Produkte zu erzeugen, die den Ansprüchen und dem Geschmack eines dynamischen und internationalen Publikums entsprechen.

Fr C'est la capacité de rester fidèle au Made in Italy, fidélité qui se traduit par une attention cohérente au choix des matériaux, par la transformation sur site de chaque composant, et par un processus de contrôle attentif et rigoureux.

Ce sont enfin des investissements constants dans la Recherche et Développement qui permettent à Bonaldo de réaliser des produits capables de satisfaire les exigences et les goûts d'un public dynamique et international.

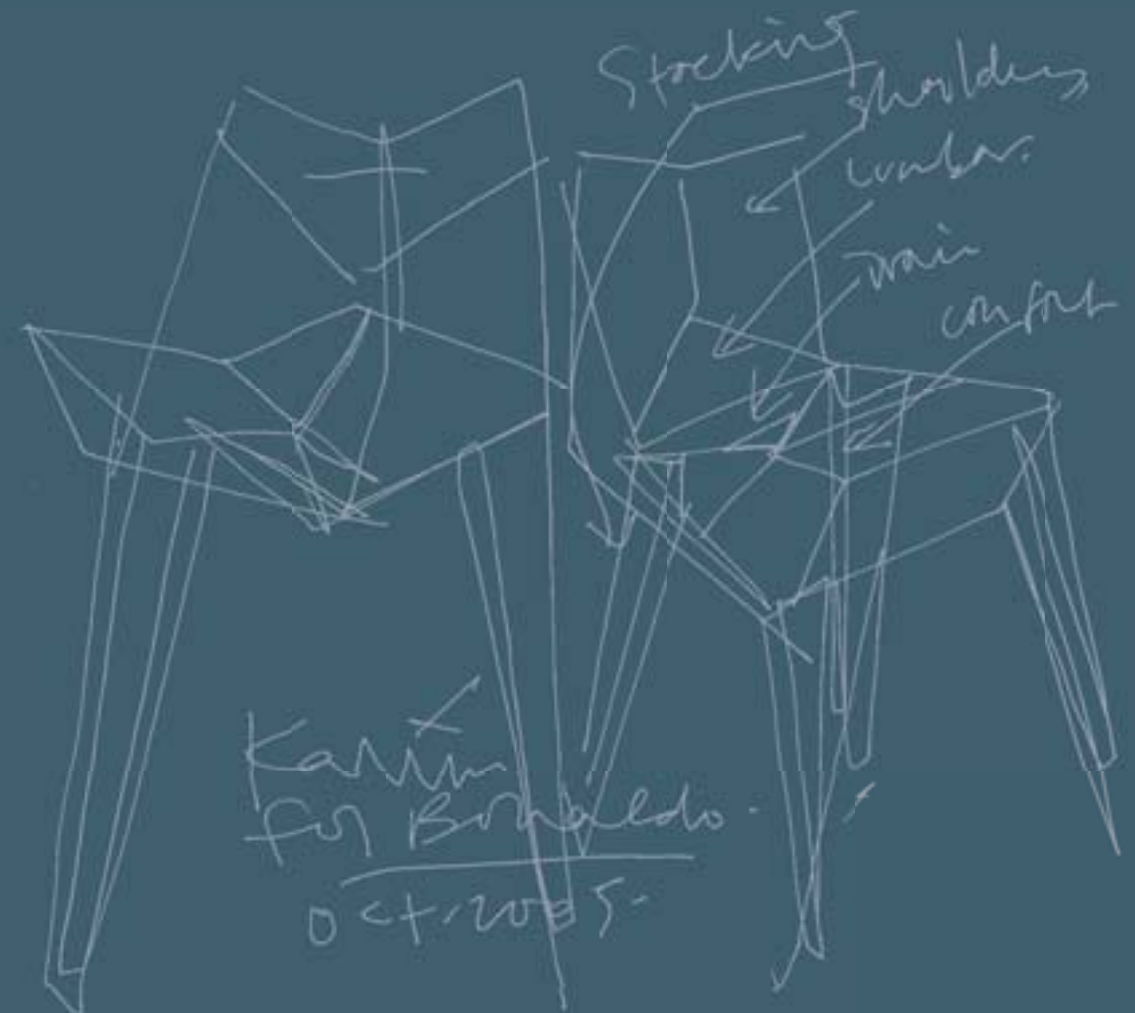

L'azienda

The company / Das Unternehmen / L'entreprise

1. UFFICI E UNITÀ PRODUTTIVA 1

*Villanova di Camposampiero (PD)
16.000 mq
Ospita la produzione di tavoli e sedie*

*OFFICES AND PRODUCTION UNIT 1
Villanova di Camposampiero (PD)
16,000 m2
Houses the production of tables and chairs*

*BÜROS UND PRODUKTIONSEINHEIT 1
Villanova di Camposampiero (PD)
16.000 m²
Hier erfolgt die Produktion von Tischen und Stühlen*

*BUREAUX ET UNITÉ DE PRODUCTION N°1
Villanova di Camposampiero (Padoue)
16 000 m2
Production de tables et chaises*

It Sono tre i luoghi della produzione nei quali il “made in Italy” Bonaldo assume corpo e sostanza. Tre strutture che assolvono il compito di dare forma tangibile ai contenuti della marca.

De In drei Produktionsstätten nehmen die Produkte “Made in Italy” von Bonaldo Körper und Gestalt an. Es gibt drei Standorte, die dem Inhalt der Marke eine greifbare Form geben.

En There are three production sites where excellence “made in Italy” by Bonaldo come to life. Three facilities which have the task of giving a tangible shape to the brand's concepts.

Fr Le Made in Italy Bonaldo prend corps dans trois sites de production, trois structures qui accomplissent la tâche de donner une forme tangible aux contenus de la marque.

2. UFFICI E UNITÀ PRODUTTIVA 2

*Borgoricco (PD)
7.000 mq
Qui vengono realizzati letti e divani.*

*BÜROS UND PRODUKTIONSEINHEIT 2
Borgoricco (PD) 7.000 m²
Hier werden Sofas und Betten hergestellt.*

*OFFICES AND PRODUCTION UNIT 2
Borgoricco (PD)
7,000 m2
This is where beds and sofas are made.*

*BUREAUX ET UNITÉ DE PRODUCTION N°2
Borgoricco (Padoue)
7000 m²
Production de canapés et lits*

3. SHOWROOM

*Borgoricco (PD)
6.000 mq
Immerso nella campagna veneta, è il luogo dell'incontro, della relazione, dello scambio.*

*SHOWROOM
Borgoricco (PD)
6.000 m²
Ein Ort der Begegnung, der Kontakte und des Austauschs, mitten im venezianischen HinterHiro.*

*SHOWROOM
Borgoricco (PD)
6,000 m2
Set in the Veneto countryside, it is the place for meeting, relating, exchanging.*

*SHOWROOM
Borgoricco (Padoue)
6000 m²
Plongé dans la campagne vénète, il est le lieu de la rencontre, de la relation et de l'échange.*



Showroom



Il Good Design Award è un riconoscimento istituito dal Chicago Athenaeum, prestigioso centro culturale statunitense dedicato al design in tutte le sue accezioni e declinazioni.

The Good Design Award is a prize offered by the Chicago Athenaeum, the famous US cultural centre dedicated to design in all its meanings and applications.

Der Good Design Award ist eine Auszeichnung des Chicago Athenaeum. Das renommierte amerikanische Kulturzentrum befasst sich mit Design in allen Varianten und Ausdrucksformen.

Le Good Design Award est un prix décerné par le Chicago Athenaeum, un centre culturel étasunien de prestige consacré au design sous toutes ses formes et ses déclinaisons.

En

Following a major restyling process that involved a surface area of approximately 6,000 m², one of the former production units was turned into the new company showroom. The showroom is now a charming and disarming setting that is the perfect place to admire Bonaldo collections, from the latest new products to icons from the past.

The space, which is also used for presentations and workshops, tells the story of the brand from the onset.

The entrance to the showroom stands out for a pathway created using colour-changing stones sourced in China, the surface of which modifies at low temperatures, creating grain patterns that recall flower motifs.

Inside the showroom, two winter gardens add further charm to the setting, with lights and colours designed to beguile visitors. In 2011, the showroom project was awarded the prestigious “Good Design Award” by the Chicago Athenaeum.

De

Die frühere Produktionsstätte mit einer Fläche von circa 6.000 m² wurde in umfangreichen Renovierungsarbeiten in den Showroom des Unternehmens umgebaut.

Der Showroom ist heute ein eindrucksvoller und spannender Ort, an dem man die Bonaldo-Kollektionen bewundern kann, von den neuen Produkten bis zu den Bonaldo-Ikonen.

Der Raum, der auch für Präsentationen und Workshops genutzt wird, erzählt die Geschichte der Marke seit den Anfängen. Der Eingang zum Showroom ist mit changierenden Steinen aus China gepflastert. Bei niedrigen Temperaturen verändert sich die Oberfläche des Steins, es entsteht eine Maserung, die an Blumenmuster erinnert.

Im Inneren des Ausstellungsraumes verleihen zwei Wintergärten dem Raum noch mehr Atmosphäre, mit überraschenden Licht- und Farbeffekten. Der Entwurf wurde 2011 mit dem renommierten Preis „Good Design Award“ des Chicago Athenaeum ausgezeichnet.

Fr

Suite à une importante opération de requalification, une surface d'environ 6 000 m² d'une ancienne unité de production a pu devenir le showroom de l'entreprise.

Le showroom est maintenant un lieu magnifique où l'on peut admirer les collections Bonaldo, des dernières nouveautés aux produits phare.

L'espace, qui est également utilisé pour des présentations et des workshops, raconte l'histoire de la marque depuis ses origines.

L'entrée du showroom est caractérisée par un parcours marqué de pierres aux couleurs chatoyantes provenant de Chine et dont la surface se modifie à basse température pour créer un veinage aux motifs floraux.

À l'intérieur de l'espace d'exposition, deux jardins d'hiver apportent un charme supplémentaire avec un éclairage et des couleurs qui surprennent le visiteur. Le projet a reçu en 2011 le prestigieux prix « Good Design Award » du Chicago Athenaeum.

Dopo un importante intervento di riqualificazione, che ha coinvolto una superficie di circa 6.000 mq, una delle vecchie unità produttive è stata trasformata nello showroom aziendale. Lo showroom è ora un luogo suggestivo ed emozionante, in cui è possibile ammirare le collezioni Bonaldo, dai nuovi prodotti alle icone. Lo spazio, che viene utilizzato anche per presentazioni e workshop, racconta la storia del marchio a partire dalle origini. L'ingresso dello showroom è caratterizzato da un percorso realizzato con pietre cangianti provenienti dalla Cina, la cui superficie si modifica con le basse temperature, creando venature che ricordano motivi floreali. All'interno dello spazio espositivo due giardini d'inverno offrono ulteriore emozione con luci e colori che sorprendono il visitatore. Il progetto ha ricevuto nel 2011 il prestigioso riconoscimento “Good Design Award” del Chicago Athenaeum.



Architetti e Designer

Sono oltre 25 i designer e architetti italiani ed internazionali che negli anni hanno contribuito a interpretare lo stile Bonaldo, tra questi Karim Rashid, Bartoli Design, Mauro Lipparini, Toshiyuki Kita, Alain Gilles...e che hanno dato all'azienda un gusto sempre più internazionale. Sono la sensibilità e la lungimiranza a permettere all'azienda non solo di instaurare un proficuo rapporto con designer e architetti di fama mondiale, ma anche di vincere i più prestigiosi premi internazionali del settore del design.

En

Architects and Designers

Over 25 different Italian and international designers and architects have contributed over the years to interpret the Bonaldo style, including Karim Rashid, Bartoli Design, Mauro Lipparini, Toshiyuki Kita, Alain Gilles...giving the brand an increasingly international outlook. Sensitivity and forward-thinking have enabled Bonaldo not only to establish a successful partnership with world-famous designers and architects, but also to win some of the most prestigious international design awards.

De

Architekten und Designer

Über 25 italienische und internationale Designer und Architekten haben in den vergangenen Jahren den Stil von Bonaldo mitinterpretiert, unter ihnen Karim Rashid, Bartoli Design, Mauro Lipparini, Toshiyuki Kita, Alain Gilles...und sie haben dem Unternehmen eine immer internationalere Linie gegeben. Mit Feingefühl und Weitblick hat das Unternehmen nicht nur eine fruchtbare Beziehung mit Designern und Architekten von Weltruhm aufgebaut, sondern auch die renommiertesten Preise im Designbereich gewonnen.

Fr

Architectes et designers

Karim Rashid, Bartoli Design, Mauro Lipparini, Toshiyuki Kita, Alain Gilles, ce ne sont que quelques noms des plus de 25 designers et architectes italiens et internationaux qui ont contribué au fil des années à interpréter le style Bonaldo, en donnant à l'entreprise une touche toujours plus internationale; La sensibilité et la clairvoyance de l'entreprise ont permis non seulement d'instaurer un rapport fructueux avec des designers et architectes de réputation mondiale, mais aussi de remporter les prix internationaux les plus prestigieux dans le secteur du design.

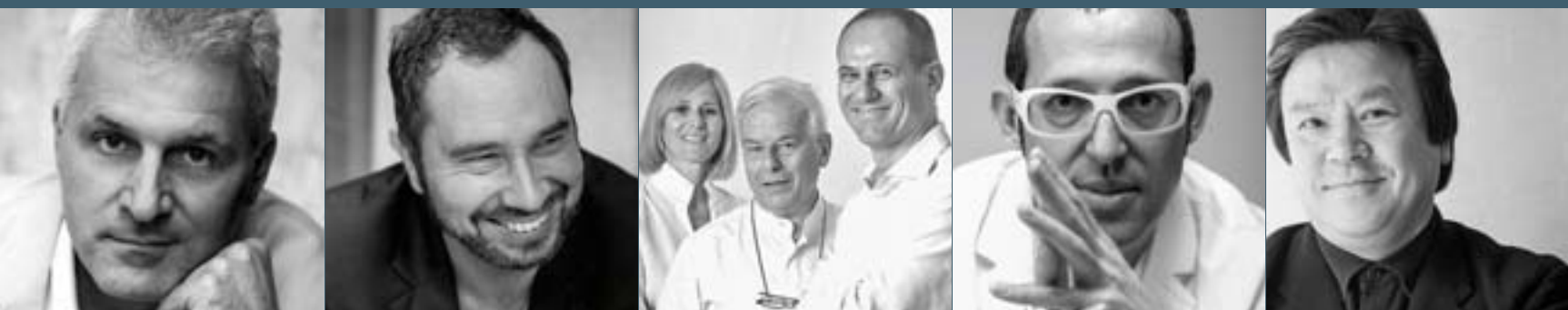

Premi

I premi ottenuti da Bonaldo in questi anni hanno sicuramente rafforzato la notorietà del brand e dei suoi prodotti, in Italia e soprattutto all'estero, dove viene rivolta molta attenzione a quelle peculiarità del Made in Italy (materiali pregiati, qualità dei progetti e dei prodotti) che sono parte integrante della filosofia aziendale.

En

Awards

The awards bestowed upon Bonaldo over the years have definitely enhanced brand and product awareness, in Italy and especially abroad, where particular focus is placed on excellence Made in Italy (fine materials, quality designs and products) which form an integral part of the corporate philosophy.

De

Preise

Die Preise, die Bonaldo in diesen Jahren erhalten hat, haben sicher die Bekanntheit der Marke und der Produkte in Italien und vor allem im Ausland, wo die Qualitäten des Labels „Made in Italy“ (hochwertige Materialien, hohe Qualität der Entwürfe und Produkte) - ein fester Bestandteil der Firmenphilosophie - große Beachtung finden, gefördert.

Fr

Prix

Les prix obtenus au fil des ans par Bonaldo ont sans aucun doute renforcé la notoriété de la marque et de ses produits, non seulement en Italie, mais aussi à l'étranger, où l'on accorde une attention particulière au Made in Italy et à ses spécificités (matériaux nobles, projets et produits de qualité), qui font partie intégrante de la philosophie d'entreprise.



reddot design award



Divani. Sofas. Sofas. Canapés.

DIVANI / SOFAS / SOFAS / CANAPÉS



DIVANI TRASFORMABILI. CONVERTIBLE SOFAS. FUNKTIONSSOFAS. CANAPÉS CONVERTIBLES



POLTRONE. ARMCHAIRS. SESSEL. FAUTEUILS

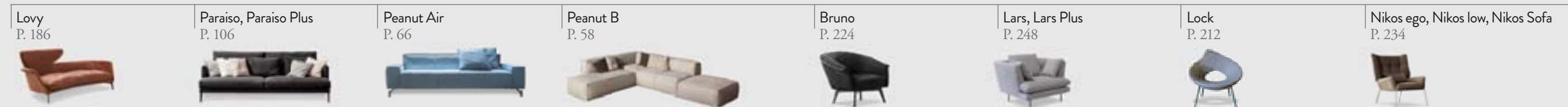
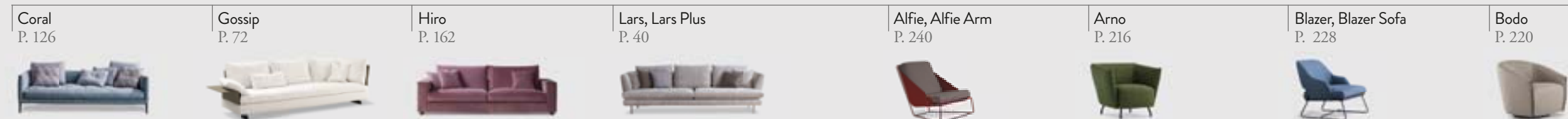

POUF

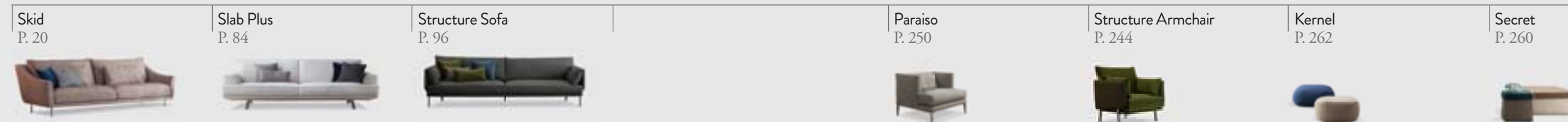

Divani Bonaldo, il comfort si fa eleganza.

Bonaldo presenta la Collezione Divani, una serie di elementi progettati e realizzati per conferire all'ambiente il massimo grado di eleganza e comfort.

La varietà delle soluzioni disponibili, grazie anche alla collaborazione con numerosi designer internazionali, consente di scegliere tra un vasto assortimento di modelli, materiali, colori e rivestimenti.

Il salotto diventa il baricentro di un mondo di affetti, un luogo di relazioni e di incontri in cui sentirsi a proprio agio. Luogo della comodità, spazio del benessere, oggetto di un design a misura d'uomo.

Divani Bonaldo, il comfort si fa eleganza.



Divani. Sofas. Sofas. Canapés

En Bonaldo sofas: where comfort meets elegance.

Bonaldo introduces its Sofa Collection, a series of furnishings designed and created to bring maximum elegance and comfort to any environment.

The wide range of solutions available, made possible also thanks to collaborations with numerous international designers, allow you to choose from an assortment of models, materials, colours and coverings.

The lounge area becomes the focal point of all connections, relationships and gatherings where you can feel at ease. A space of comfort and well-being with a piece of furniture designed around people.

Bonaldo sofas: where comfort meets elegance.

De Bonaldo Sofas, Komfort wird zu Eleganz.

Bonaldo präsentiert die Sofakollektion, eine Reihe von Elementen, die entworfen und umgesetzt werden, um dem Raum höchste Eleganz und Komfort zu verleihen.

Auch dank der Mitarbeit zahlreicher internationaler Designer ermöglicht die Vielfalt der verfügbaren Lösungen, aus einem großen Sortiment an Modellen, Materialien, Farben und Bezügen auszuwählen.

Das Wohnzimmer wird zum Mittelpunkt in einer Welt der Liebe, ein Ort der Beziehungen und Begegnungen, wo man sich wohlfühlt.

Ort des Komforts, Raum des Wohlbefindens, Gegenstand eines menschengerechten Designs. Bonaldo Sofas, Komfort wird zu Eleganz.

Fr Canapés Bonaldo, lorsque confort rime avec élégance.

Bonaldo présente sa collection de canapés, une série d'éléments conçus et réalisés pour offrir à la pièce le plus haut niveau d'élégance et de confort.

La variété des solutions disponibles, grâce aussi à la collaboration avec de nombreux designers internationaux, permet de choisir parmi un vaste assortiment de modèles, matériaux, couleurs et revêtements.

Le salon devient le centre barrique d'un monde d'affections, un lieu de relations et de rencontres dans lequel se sentir à l'aise. Lieu de la commodité, espace du bien-être, objet d'un design à taille humaine.

Canapés Bonaldo, lorsque confort rime avec élégance.

Skid

Skid è un divano caratterizzato dalla leggerezza formale. L'inclinazione dei braccioli e i piedini in metallo, disponibili dritti o a slitta, lo sollevano da terra, alleggeriscono le linee e rendono originale la visione di insieme.

En The Skid sofa features lightness of form. The inclination of the armrests and the metal feet, available both straight and sliding, lift the sofa up from the ground, making the lines softer and offering an original layout.

De Skid ist ein Sofa, das von leichten Formen geprägt ist. Die Neigung der Armlehnen und die Metallbeine, die geradlinig oder kufenförmig verfügbar sind, heben es vom Boden ab, machen seine Linien leicht und sorgen für eine originelle Gesamtansicht.

Fr Skid est un canapé caractérisé par la légèreté de ses formes. L'inclinaison des accoudoirs et les petits pieds en métal, disponibles droits ou coulissants, le soulèvent de terre, allègent les lignes et rendent originale la vision d'ensemble.

Skid Giuseppe Viganò





Skid Giuseppe Viganò
Divano. Sofa. Sofa. Canapé
Alfie Arm Giuseppe Viganò
Poltrona. Armchair. Sessel. Fauteuil



Skid Giuseppe Viganò
Divano. Sofa. Sofa. Canapé
Nikos low Sergio Bicego
Poltrona. Armchair. Sessel. Fauteuil



Skid Giuseppe Viganò
Divano. Sofa. Sofa. Canapé
Bodo Mauro Lipparini
Poltrona. Armchair. Sessel. Fauteuil

Colors

Il divano Colors è un divano rigoroso nelle sue forme lineari. La caratteristica principale è data dalla fascia di tessuto che corre su tutto il perimetro dei cuscini della seduta, della scocca e dei braccioli. La fascia può essere scelta in colore (da cui il nome COLORS) a contrasto con il resto del rivestimento: tonalità e disegni danno la possibilità di personalizzare il divano e creare particolari armonie o effetti cromatici.

En The Colors sofa is rigorous in its linear shapes. Its stand-out feature is the strip of fabric which runs along the perimeter of the cushions on the chair, the body and the armrests. The strip can be chosen in different colours (hence the name of the product) in contrast with the rest of the covering; different tones and designs allow you to personalise the sofa and create unique harmonies and chromatic effects.

De Das Sofa Colors präsentiert sich präzise in seinen linearen Formen. Das Hauptmerkmal ist ein Stoffband, das die Außenkanten der Sitzkissen, des Gestells und der Armlehnen ziert. Das Band ist wahlweise in einer Farbe verfügbar (daher auch der Name COLORS), die einen Kontrast zum restlichen Bezug bietet: Farbtöne und Muster bieten die Möglichkeit, das Sofa individuell zu gestalten und besonders harmonische oder farblich unterschiedliche Kombinationen zu kreieren.

Fr Le canapé Colors est un canapé rigoureux de par ses formes linéaires. Sa caractéristique principale est la bande de tissu qui s'étend sur tout le périmètre des coussins de l'assise, de la coque et des accoudoirs. La bande peut être choisie dans une couleur (d'où le nom COLORS) qui contraste avec le reste du revêtement : les tonalités et les motifs donnent la possibilité de personnaliser le canapé et de créer des harmonies particulières ou des effets chromatiques.





Colors Sergio Bicego



Colors Sergio Bicego







Colors Sergio Bicego



Colors Sergio Bicego

Lars

Lars Plus

Lars, divano connotato da un'immagine aerea e sospesa, con i suoi importanti cuscini trasmette un'idea di comfort e relax. I braccioli sono dolcemente inclinati verso l'esterno; i piedini sono costituiti da una sottile linea metallica o da un basamento a slitta in metallo verniciato. I divani Lars sono disponibili in due diverse altezze di schienale (alto o basso) e garantiscono la massima componibilità grazie ai numerosi elementi quali chaise longue, penisole e pouf.

Disponibile anche nella versione Lars Plus, con base seduta più alta e piedi più corti.

En Lars, a sofa which is raised above the floor and appears to be suspended, features big cushions and conveys a sense of comfort and relaxation. The armrests are gently inclined outwardly; the feet are made of a thin metal line or a sliding base in painted metal. The Lars sofas are available with two different backrests (high or low) and guarantee maximum modularity thanks to numerous elements such as chaises longues, peninsulas and poufs.

Also available in the Lars Plus version with a higher seat base and shorter feet.

-

De Lars präsentiert sich als Sofa, das von einem luftigen und beinahe schwebenden Design geprägt ist und vermittelt mit seinen auffallenden Sitzkissen das Gefühl von Komfort und Entspannung. Die Armlehnen sind sanft nach außen geneigt. Die Beine bestehen aus einer schmalen Metalllinie oder sind kufenförmig und aus lackiertem Metall. Die Sofas Lars sind in zwei verschiedenen Höhen der Rückenlehnen (hoch oder tief) erhältlich und garantieren dank der zahlreichen Elemente, wie Chaiselongues, Halbinseln und Sitzpuffs verschiedenste Kombinationsmöglichkeiten.

Verfügbar auch in der Version Lars Plus mit höherer Sitzfläche und niedrigeren Beinen.

-

Fr Lars, est un canapé qui évoque une image aérienne, suspendue, qui transmet une idée de confort et de détente grâce à ses grands coussins. Les accoudoirs sont doucement inclinés vers l'extérieur ; les pieds sont constitués d'une fine ligne métallique ou d'une base coulissante en métal peint. Les canapés Lars sont disponibles en deux hauteurs de dossier différentes (haut et bas) et garantissent un maximum de modularité grâce aux nombreux éléments comme les chaises-longues, péninsules et poufs.

Disponible également dans la version Lars Plus, avec la base de l'assise plus haute et les pieds plus courts.

Lars Giuseppe Viganò





Lars Giuseppe Viganò



Lars Giuseppe Viganò



Lars Giuseppe Viganò



Lars Giuseppe Viganò
Divano. Sofa. Sofa. Canapé
Lars Giuseppe Viganò
Poltrona. Armchair. Sessel. Fauteuil



Lars Plus Giuseppe Viganò



Lars Giuseppe Viganò



Lars Giuseppe Viganò
Divano. Sofa. Sofa. Canapé
Alfie Giuseppe Viganò
Poltrona. Armchair. Sessel. Fauteuil



Peanut B

Una morbidezza avvolgente che regala giorno dopo giorno intensi momenti di relax. Peanut B, grazie ai numerosi elementi a disposizione, è un divano estremamente versatile, che si adatta ad ogni esigenza di spazio e di stile. Peanut B può essere composto anche ad isola e messo a centro stanza per creare un ampio spazio “socializzante”.

Disponibile anche nella versione aerea, Peanut Air.

En Enveloping softness which confers intense moments of relaxation day after day. Thanks to the many elements available, Peanut B is an extremely versatile sofa which adapts to every style or space requirement. Peanut B can also be arranged like an island and be placed at the centre of the room to create a space in which to socialise. Also available in its raised above the floor version, Peanut Air.

De Umhüllende Geschmeidigkeit, die Tag für Tag intensive Entspannungsmomente schenkt. Peanut B ist, dank der zahlreichen zur Verfügung stehenden Elemente, ein äußerst vielseitiges Sofa, das sich sämtlichen Raum- und Stilanforderungen anpasst. Peanut B kann auch als Insel zusammengestellt und in der Raummitte positioniert werden, um einen großen „kommunikationsfreundlichen“ Bereich zu schaffen.

Auch in der luftigen Version Peanut Air verfügbar.

Fr Son moelleux enveloppant offre d'intenses moments de détente, jour après jour. Peanut B, grâce aux nombreux éléments disponibles, est un canapé polyvalent, qui s'adapte à toutes les exigences d'espace et de style. Peanut B peut être composé également en îlot et placé au centre de la pièce afin de créer un grand espace de « socialisation ».

Disponible également dans la version aérienne, Peanut Air.

Peanut B Mauro Lipparini





Peanut B Mauro Lipparini



Peanut B Mauro Lipparini





Peanut B Mauro Lipparini





Peanut Air Mauro Lipparini





Peanut Air Mauro Lipparini



Peanut Air Mauro Lipparini
Divano. Sofa. Sofa. Canapé
Bruno Mauro Lipparini
Poltrona. Armchair Sessel. Fauteuil

Gossip

Un modo sempre originale di interpretare e vivere la propria casa. Il divano Gossip è caratterizzato da un particolare sistema di moduli combinabili. La sua versatilità è molto ampia: nel perimetro delle basi, infatti, possono essere liberamente inseriti, secondo le diverse esigenze, schienali con cuscini d'appoggio, braccioli, mensole o tavolini.

En An original way to interpret and enjoy one's home. The Gossip sofa is made up of a unique system of combinable modules. Its versatility is wide: in the perimeter of the bases it is possible to insert, depending on different needs, backrests with cushions, armrests, shelves or small tables.

De Eine stets originelle Art, sein Heim zu interpretieren und zu erleben. Das Sofa Gossip ist von einem speziellen System kombinierbarer Module geprägt. Es weist eine besonders große Vielfalt auf: Rund um das gesamte Untergestell können nämlich beliebig den verschiedenen Anforderungen entsprechend Rückenlehnen mit Stützkissen, Armlehnen, Ablagen oder Beistelltische aufgesteckt werden.

Fr Une manière toujours originale d'interpréter et de vivre son habitation. Le canapé Gossip est caractérisé par un système particulier de modules à combiner. Sa polyvalence est très étendue : en effet, au niveau des modules de base, il est possible d'intégrer, selon les besoins, des dossiers avec coussins d'appui, des accoudoirs, des étagères ou des petites tables.

Gossip Sergio Bicego





Gossip Sergio Bicego



Gossip Sergio Bicego



Gossip Sergio Bicego
Divano. Sofa. Sofa. Canapé





Gossip Sergio Bicego

Slab Plus

La linearità rigorosa delle forme e la morbidezza dei materiali convivono in una collezione di divani che invita al totale relax. Slab Plus grazie alle sue linee originali, garantisce alla casa una modernità equilibrata, perfetta per zone living dallo spirito contemporaneo.

En Rigorous linearity of shapes and softness of material coexist in this sofa collection which inspires total relaxation. Thanks to its original lines, Slab Plus brings a balanced modernity to the home, perfect for living areas with a contemporary spirit.

De Die strenge Geradlinigkeit der Formen und die weichen Materialien vereinen sich in einer Sofakollektion, die zu vollkommener Entspannung einlädt. Dank der originellen Linien garantiert Slab Plus dem Heim eine ausgeglichene Modernität, ideal für zeitgemäß gestaltete Wohnbereiche.

Fr La linéarité rigoureuse des formes et la douceur des matériaux se font écho dans une collection de canapés qui invite à la détente la plus totale. Grâce à ses lignes originales, Slab Plus garantit une modernité équilibrée à l'habitation, parfaite pour les zones living au style contemporain.

Slab Plus Mauro Lipparini





Slab Plus Mauro Lipparini



Slab Plus Mauro Lipparini



Slab Plus Mauro Lipparini



Slab Plus Mauro Lipparini



Structure Sofa

Un'anima in metallo definisce la logica progettuale di Structure Sofa: la struttura talvolta viene messa in evidenza, mentre in altri casi è parzialmente nascosta, conferendo un aspetto assolutamente informale, con effetti estetici originali e personalizzati dalla scelta degli abbinamenti di colori e materiali.

En A metal core defines the project logic of Structure Sofa: the structure is sometimes highlighted, whilst in other cases it is partially hidden, conferring a totally informal vibe, with original aesthetic features, personalised by the choice of combinations of colours and materials.

De Ein Metallgestell bestimmt das Design von Structure Sofa: Zum Teil wird das Gestell als Blickfang in Szene gesetzt, zum Teil ist es kaum zu sehen und verleiht so dem Sofa einen vollkommen informellen Look, wobei die Auswahl der Farb- und Materialzusammenstellungen für originelle und individuelle optische Wirkung sorgt.

Fr Une âme en métal définit la logique conceptuelle de Structure Sofa : parfois la structure est mise en valeur, alors que dans d'autres cas elle est partiellement cachée, donnant ainsi un aspect totalement informel, avec des effets originaux et personnalisés par le choix des mariages de couleurs et de matériaux.

Structure Sofa Alain Gilles





Structure Sofa Alain Gilles



Structure Sofa Alain Gilles



Structure Sofa Alain Gilles
Structure Armchair Alain Gilles



Structure Armchair Alain Gilles



Structure Sofa Alain Gilles

Paraiso Paraiso Plus

Un modello di divano classico dal gusto sobrio, essenziale ed elegante che, grazie ai suoi volumi equilibrati, si adatta ad ambienti di diverse dimensioni e stili. Paraiso o Paraiso Plus, variante con cuscini schienale integrati nella scocca e profondità della seduta minore, con rivestimento in tessuto o pelle, soddisfa pienamente i diversi gusti e desideri di comfort. Paraiso è disponibile anche nella versione con balza.

En A classic kind of sofa with a simple, essential and elegant taste, which, thanks to its balanced volumes, adapts to a variety of environments, sizes and styles. Paraiso or Paraiso Plus, a variant with an integrated back cushion and deep lower seat with a fabric or leather covering, fully satisfies the different tastes and needs for comfort. Paraiso is also available in the version with a frill.

De Ein klassisches Sofamodell im schlichten, nüchternen und eleganten Stil, das sich dank der harmonischen Proportionen an unterschiedliche Raumgrößen und Einrichtungsstile anpasst. Paraiso oder Paraiso Plus, die Version mit in das Gestell integrierten Lehnkissen und tieferer Sitzfläche, mit Stoff- oder Lederbezug, wird ganz den verschiedenen Geschmacksansprüchen und Komfortwünschen gerecht. Paraiso ist auch in der Version mit Volant verfügbar.

Fr Ce modèle de canapé classique au goût sobre, essentiel et élégant s'adapte à des milieux de différentes dimensions et styles grâce à ses volumes équilibrés. Paraiso ou Paraiso Plus, variante avec les coussins du dossier intégrés à la coque et une profondeur d'assise inférieure, avec revêtement en tissu ou en cuir souple, satisfait en tous points les différents goûts et désirs de confort. Paraiso est également disponible dans la version avec volant.

Paraiso Sergio Bicego





Paraiso Sergio Bicego





Paraiso Sergio Bicego



Paraiso Sergio Bicego





Paraiso Sergio Bicego



Paraiso Sergio Bicego
Poltrona. Armchair. Sessel. Fauteuil





Paraiso Plus Sergio Bicego



Paraiso Plus Sergio Bicego



Paraiso Plus Sergio Bicego



Coral

Un linguaggio estetico che declina i valori dell'essenzialità e del relax e che li interpreta in chiave moderna. Il divano Coral rappresenta una scelta di comfort e rifugio: con la sua seduta generosa, regala una comodità senza precedenti.

En An aesthetic language that showcases the values of essentiality and relaxation and interprets them in a modern way. Coral represents a choice of ease and shelter: with its wide seat, it offers unparalleled comfort.

De Ästhetik, die die Werte von Schlichtheit und Entspannung ablehnt und auf moderne Weise interpretiert. Das Sofa Coral verkörpert Komfort und Wohlbefinden: Mit einer großzügigen Sitzfläche bietet es unvergleichliche Gemütlichkeit.

Fr Un langage esthétique qui décline les valeurs de l'essentialité et de la détente en les interprétant dans un esprit moderne. Le canapé Coral représente un choix de confort et de refuge : son assise généreuse offre une commodité sans égale.





Coral Sergio Bicego



Coral Sergio Bicego



Coral Sergio Bicego





Coral Sergio Bicego



Coral Sergio Bicego



Alvar Sofa

Alvar Sofa è un divano capace di assumere una diversa fisionomia, di cambiare immagine a seconda del tipo di soluzione adottata e delle scelte cromatiche e di rivestimento. È infatti possibile combinare elementi alti o bassi, con impunture o trapuntature diverse in ogni singolo componente.

Il nome Alvar è ispirato ad uno dei grandi nomi del design internazionale (Alvar Aalto).

En Alvar Sofa is a sofa that can change its image and layout depending on the type of solution adopted, colour scheme and covering. It is in fact possible to combine high or low elements with different stitching or quilting in every single component.

The name Alvar is inspired by the great international designer (Alvar Aalto).

-

De Alvar Sofa ist ein Sofa, das verschiedene Gestaltungsformen annimmt und sich je nach Ausführung und Farb- sowie Bezugwahl in unterschiedlichem Design präsentiert. So werden hohe oder tiefe Elemente miteinander kombiniert, mit verschiedenen Steppnähren in jedem einzelnen Bestandteil.

Der Name Alvar inspiriert sich an einem der großen Persönlichkeiten des internationalen Designs (Alvar Aalto).

Fr Alvar Sofa est un canapé en mesure d'adopter une physionomie différente, de changer d'image selon le type de solution adoptée ainsi que les choix de couleur et de revêtement. En effet, il est possible de combiner des éléments hauts ou bas, avec des piqûres ou matelassages différents pour chaque élément.

Le nom Alvar dérive d'un des grands noms du design international, Alvar Aalto.



Alvar Sofa Giuseppe Viganò



Alvar Sofa Giuseppe Viganò



Alvar Sofa Giuseppe Viganò



Alvar Sofa Giuseppe Viganò
Divano. Sofa. Sofa. Canapé
Arno Mauro Lipparini
Poltrona. Armchair. Sessel. Fauteuil



Alvar Sofa Giuseppe Viganò



Alvar Sofa Giuseppe Viganò



Avarit

Avarit è un divano caratterizzato da un alto grado di componibilità e di personalizzazione, grazie all'ampia gamma di elementi e di rivestimenti tra cui è possibile scegliere. Con i suoi grandi ed importanti cuscini rimovibili che costituiscono allo stesso tempo seduta e schienale diventa non solo un divano, ma un vero e proprio modo di vivere lo spazio.

En Avarit is a sofa with a high degree of modularity and personalisation, thanks to a wide range of elements and coverings which it is possible to choose from. With its big, impressive movable cushions which are both the seat and the backrest it becomes not only a sofa, but also an actual living space.

De Avarit ist ein Sofa mit verschiedensten Gestaltungsmöglichkeiten und Zusammenstellungen Aufgrund einer Vielzahl von zur Auswahl stehenden Elementen und Bezügen. Mit Seinen großen und auffallenden Sitz- und Rückenkissen, die auch entfernt werden können, ist es nicht nur ein Sofa, sondern eine besondere Art, den Raum zu erleben.

Fr Avarit est un canapé caractérisé par un niveau élevé de modularité et de personnalisation, grâce à la vaste gamme d'éléments et de revêtements parmi lesquels choisir. Avec ses grands coussins importants amovibles qui constituent à la fois l'assise et le dossier, il fait office non seulement de canapé, mais aussi de véritable mode de vivre l'espace.

Avarit Giuseppe Viganò





Avarit Giuseppe Viganò
Divano. Sofa. Sofa. Canapé





Avarit Giuseppe Viganò





Avarit Giuseppe Viganò



Avarit Giuseppe Viganò



Hiro

Hiro è un divano componibile caratterizzato dalla sobrietà dell'immagine e da una linea che interpreta con gusto originale le forme della tradizione, che evocano atmosfere ricche di fascino e di un'eleganza intramontabile. Hiro permette di ottenere composizioni dal gusto decisamente classico e sofisticato.

En Hiro is a modular sofa characterised by sobriety and by a line which interprets with originality the shapes of tradition, evoking charm and timeless elegance. Hiro allows you to create compositions which are decidedly classic and sophisticated.

De Hiro ist ein Modulsofa, das von einem schlichten Design geprägt ist. Seine Linien interpretieren auf originelle Weise traditionelle Formen, die eine magische Atmosphäre und unvergängliche Eleganz wiedergeben. Hiro lässt entschieden klassische und raffinierte Zusammenstellungen entstehen.

Fr Hiro est un canapé modulaire caractérisé par la sobriété de l'image et par une ligne qui interprète de manière originale les formes de la tradition, qui évoquent des atmosphères pleines de charme et à l'élégance indémodable. Hiro permet d'obtenir des compositions à l'aspect classique et sophistiqué très marqué.



Hiro





Hiro
Divano. Sofa. Sofa. Canapé



Hiro



Hiro



Hiro







Hiro



Cave

Cave è un divano dalle linee pulite, continue e dal comfort disinvolto. Esprime una naturale propensione all'equilibrio e all'armonia. Grazie alla morbidezza delle sue forme, prive di spigoli, Cave è al servizio di chi lo usa, del suo stile di vita e del suo personale concetto di comodità.

En Cave is a sofa with clean, continuous lines which conveys casual comfort. It expresses a natural propensity to balance and harmony. Thanks to the softness of its shapes, which have no sharp edges, Cave is at the service of those who use it, their lifestyles and personal concept of comfort.

De Cave ist ein Sofa mit geraden und fortlaufenden Linien und ungezwungenem Komfort. Es ist Ausdruck einer natürlichen Tendenz zu Ausgewogenheit und Harmonie. Dank seiner weichen, kantenlosen Formen steht Cave im Dienste der Benutzer; ihres Lebensstils und der persönlichen Vorstellung von Bequemlichkeit.

Fr Cave est un canapé aux lignes épurées, continues et au confort désinvolte. Il exprime une propension naturelle à l'équilibre et à l'harmonie. Grâce à la douceur de ses formes, sans angles, Cave se met au service de celles et ceux qui l'utilisent, de leur style de vie et de leur concept personnel de commodité.



Cave Mauro Lipparini





Cave Mauro Lipparini



Cave Mauro Lipparini



Cave Mauro Lipparini

It I diversi tipi di braccioli, oppure portaoggetti in cuoio possono essere liberamente inseriti sui lati estremi della scocca contribuendo ad una personalizzazione sia estetica sia funzionale.

En The different types of emery-leather armrests or storage solutions can be freely inserted at the far ends of the body giving a functional and aesthetic personalisation.

De Verschiedene Arten von Armlehnen, sowie Gegenstände können beliebig an den Enden des Gestells befestigt werden und tragen so zu einer sowohl ästhetischen als auch funktionellen Gestaltung des Sofas bei.

Fr Les différents types d'accoudoirs, ou bien les rangements en cuir, peuvent être placés librement aux extrémités de la coque, en contribuant ainsi à une personnalisation à la fois esthétique et fonctionnelle.



Lovy

Lovy è un divano fisso dalle linee originali, caratterizzato dallo schienale a due altezze che crea movimento dal punto di vista visivo. La particolare forma semi-ovale dello schienale invita alla conversazione, rendendolo adatto per essere usato anche a centro stanza.

En Lovy is a fixed sofa with original lines; it features a backrest with two heights which creates movement from a visual point of view. The unique semi-oval shape of the backrest invites you to sit and chat, and also makes it suitable to be used at the centre of a room.

-

De Lovy präsentiert sich als Sofa mit originellen Linien, das mit den zwei unterschiedlichen Höhen der Rückenlehne optisch Bewegung ins Bild bringt. Die besondere halb-ovale Form der Rückenlehne lädt zum gemeinsamen Gespräch ein, weshalb es auch gut in der Raummitte verwendet werden kann.

-

Fr Lovy est un canapé fixe aux lignes originales, caractérisé par le dossier à deux hauteurs qui crée un mouvement du point de vue visuel. La forme semi-ovale particulière du dossier invite à la conversation et le rend parfait pour une utilisation au centre de la pièce.

Lovy Sergio Bicego





Lovy Sergio Bicego





Lovy Sergio Bicego

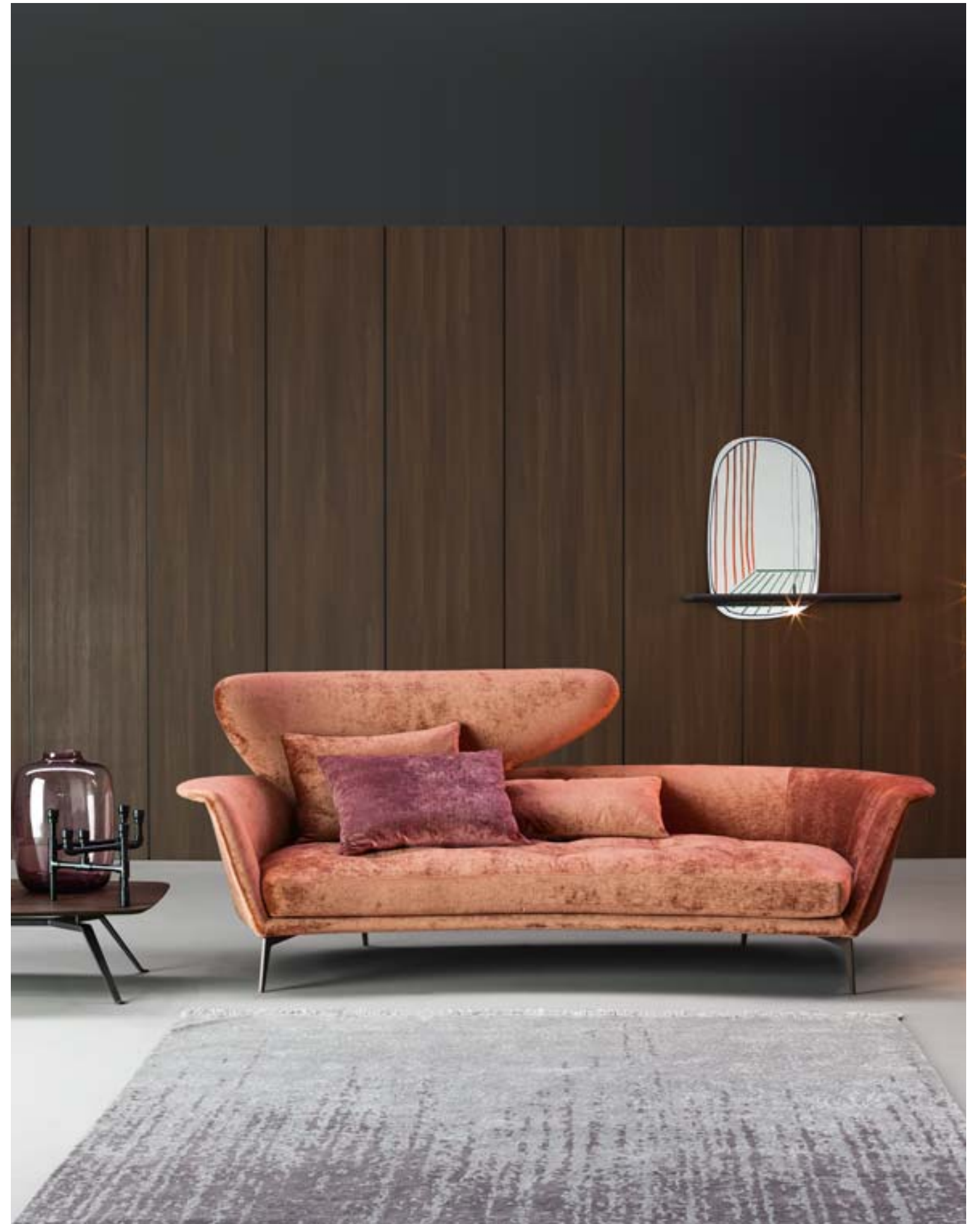

Divani trasformabili Bonaldo:
elogio di una vita in movimento.
Una soluzione destinata a chi
ama una vita che riserva piacevoli
sorprese e incontri inattesi. La
Collezione di divani trasformabili
Bonaldo: una scelta progettuale
naturalmente dinamica e con un
gusto contemporaneo, che consente
di risolvere in modo semplice e
funzionale un problema di spazio o
una visita inaspettata.



Divani Trasformabili. Convertible Sofas. Funktionssofas. Canapés Convertibles

En Bonaldo's transformable sofas: an ode to life in movement

A solution destined to those who love a life full of pleasant surprises and unexpected encounters. Bonaldo's transformable sofa collection: a naturally dynamic project choice with a contemporary feel which allows to solve problems of space or an unexpected visit in a simple and functional way.

De Bonaldo Funktionssofas: Lob an ein bewegtes Leben

Eine Lösung für alle, die ein Leben mit angenehmen Überraschungen und unerwarteten Begegnungen lieben. Die Funktionssofaskollektion von Bonaldo: ein natürliches dynamisches Design mit zeitgenössischem Geschmack, das auf einfache und funktionelle Weise ein Raumproblem löst oder bei einem unerwarteten Besuch dient.

Fr Canapés transformables Bonaldo : éloge d'une vie en mouvement

Une solution destinée à celles et ceux qui aiment une vie qui réserve d'agréables surprises et des rencontres inattendues. La collection de canapés transformables de Bonaldo : un choix conceptuel naturellement dynamique et à l'aspect contemporain, qui permet de résoudre de manière simple et fonctionnelle un problème d'espace ou de visite inattendue.

Bandy

Una forma leggera e sospesa,
un divano trasformabile
facilmente integrabile nel living
contemporaneo. Bandy si
trasforma agevolmente da divano
a letto: il meccanismo è manuale,
con la seduta che avanza e lo
schienale che scende per formare
un comodo piano letto.

En A light, suspended shape; a convertible sofa which easily integrates into the contemporary living space. Bandy easily transforms from a sofa into a bed: the mechanism is manual; the seat moves forward and the backrest lowers to form a comfortable bed surface.

De Eine leichte und schwebende Form, ein Funktionssofa, das sich einfach in moderne Wohnbereiche einbeziehen lässt. Bandy verwandelt sich problemlos vom Sofa zum Bett: Der Mechanismus wird manuell betätigt, die Sitzfläche gleitet nach vorne und die Rückenlehne wird so weit abgesenkt, bis eine bequeme Liegefläche entsteht.

Fr Une forme légère et suspendue, un canapé convertible qui s'intègre facilement au living. Bandy se transforme aisément de canapé en lit : le mécanisme est manuel, avec l'assise qui avance et le dossier qui se baisse pour former un plan-lit.

Bandy PierVittorio Prevedello





Bandy PierVittorio Prevedello





Bandy PierVittorio Prevedello



Papillon

Le forme sinuose ed avvolgenti evocano l'eleganza del volo di una farfalla. Papillon è un divano trasformabile di grande fascino, con schienali reclinabili fino a ottenere un piano letto. È disponibile anche nella versione Papillon XL: le dimensioni maggiori favoriscono ulteriore comfort, pur mantenendo le stesse caratteristiche di design e funzionalità.

En Its sinuous and enveloping shapes remind us of the flight of a butterfly. Papillon is a highly appealing transformable sofa, with backrests that recline into a bed surface. It is also available in the XL Papillon version: the bigger sizes favour extra comfort, while maintaining the same features of design and functionality.

De Die geschwungenen und umhüllenden Formen erinnern an die Eleganz eines fliegenden Schmetterlings. Papillon ist ein ausgesprochen faszinierendes Funktionssofas mit zurückklappbaren Rückenlehnen, die eine Liegefläche entstehen lassen. Es ist auch in der Version Papillon XL erhältlich: Die größeren Abmessungen stehen für höheren Komfort, obwohl Design- und Funktionalitätsmerkmale beibehalten werden.

Fr Les formes sinueuses et enveloppantes évoquent l'élégance du vol d'un papillon. Papillon est un canapé transformable plein de charme, avec des dossiers inclinables pour obtenir un plan-lit. Il est également disponible dans la version Papillon XL : ses dimensions supérieures offrent un confort supplémentaire tout en conservant ses caractéristiques de design et de fonctionnalité.

Papillon XL





Papillon XL

Pierrot

Linee nitide e definite, eleganti e di grande praticità, declinate secondo le esigenze dell'arredo moderno. Pierrot è un divano trasformabile dinamico e versatile: con un semplice movimento, lo schienale si abbassa fino a diventare un comodo piano sonno. Nella versione Pierrot King, il rivestimento è trapuntato.

En Clean, defined, elegant and highly practical lines, created according to the needs of modern furnishing. Pierrot is a dynamic and versatile transformable sofa: with a simple movement, the backrest goes down until it becomes a comfortable surface on which to sleep. In the Pierrot King version, the covering is quilted.

De Saubere, klar definierte, elegante und praktische Linien, die sich den Ansprüchen moderner Einrichtung anpassen. Das Funktionssofa Pierrot präsentiert sich dynamisch und vielseitig: Mit einer einfachen Bewegung lässt sich die Rückenlehne absenken, um eine bequeme Liegefläche entstehen zu lassen. Die Version Pierrot King weist einen gesteppten Bezug auf.

Fr Lignes nettes et définies, élégantes et très pratiques, déclinées selon les exigences du mobilier moderne. Pierrot est un canapé transformable dynamique et polyvalent : avec un simple mouvement, le dossier se baisse jusqu'à devenir un plan-lit. Le revêtement est matelassé dans la version Pierrot King.

Pierrot King







Pierrot



Pierrot King

Poltrone Bonaldo: oggetti di design, momenti di vita.

Le poltrone Bonaldo sono oggetti che, per il loro contenuto estetico e per la capacità di rispondere a una precisa domanda di funzionalità, sono in grado di dare all'ambiente domestico valore e personalità, assumendo sempre più un ruolo da protagonisti. In virtù di una progettazione attenta ad ogni dettaglio le poltrone, sono elementi che animano la zona living della casa e creano dinamicità all'interno di una scenografia privata che diventa spazio di vita.

Poltrone. Armchairs. Sessel. Fauteuils



En Bonaldo Armchairs: designer objects, storytellers of life.

Due to their aesthetic quality and their ability to respond to a precise need for functionality, Bonaldo armchairs are capable of giving the home environment value and personality, and take on a central role. By virtue of a careful design which pays attention to every detail, they are elements which bring to life the living area of the house and create dynamicity within a private space which becomes a living space.

De Bonaldo Sessel: Designobjekte, Augenblicke des Lebens.

Bonaldo Sessel sind Objekte, die Aufgrund ihres ästhetischen Werts und ihrer Fähigkeit, einer bestimmten Funktionalitätsanforderung entsprechen, dem Wohnraum Bedeutung und Persönlichkeit verleihen und dabei immer mehr im Mittelpunkt stehen. Anhand eines Designs, das die Bedeutung jedes Details berücksichtigt, beleben diese Sessel den Wohnbereich eines Heims und schaffen Dynamik in einer privaten Bühnengestaltung, die zum Lebensraum wird.

Fr Fauteuils Bonaldo : objets de design, moments de vie.

Les fauteuils Bonaldo sont des objets qui, de par leur contenu esthétique et leur capacité à répondre à une demande précise de fonctionnalité, sont en mesure de procurer à la pièce de la valeur et de la personnalité, en jouant de plus en plus le rôle de protagoniste. Grâce à leur conception à l'écoute de chaque détail, ce sont des éléments qui animent la zone living de l'habitation et créent une dynamique à l'intérieur d'une mise en scène privée qui devient un espace de vie.

Lock

Una seduta capace di esprimere un senso di protezione e comfort. Lock è una poltrona che pone l'uomo al centro, sviluppandosi attorno ad esso attraverso una fascia imbottita che si chiude su se stessa a formare uno schienale che esprime una sensazione di intimità e sicurezza.

En A seat capable of expressing a sense of protection and comfort. Lock is an armchair which places man at the centre; it develops around the person sitting using a padded strip which closes on itself to make a backrest which expresses a sense of intimacy and safety.

De Eine Sitzgelegenheit, die ein Gefühl von Geborgenheit und Komfort vermittelt. Lock ist ein Sessel, der den Benutzer in den Mittelpunkt stellt, ihn wie ein gepolstertes Band umgibt, das sich zu einer Rückenlehne schließt und ein Gefühl von Vertrautheit und Geborgenheit entstehen lässt.

Fr Un siège capable d'exprimer un sens de protection et de confort. Lock est un fauteuil qui place l'homme au centre, en se développant autour de lui à travers une bande rembourrée qui se referme sur elle-même pour former un dossier qui exprime une sensation d'intimité et de sécurité.



Lock Alessandro Busana





Lock Alessandro Busana



Arno

Arno è una poltrona di forma quadrata con i piedini in metallo verniciato. È realizzata con un rivestimento di taglio sartoriale di qualità che la rende particolarmente adatta a zone living importanti. Arno fa parte di una linea di poltrone sofisticate, declinate in diversi linguaggi geometrici.

En Arno is a square-shaped armchair with metal-painted feet. It is made with a tailor-made high-quality covering which makes it particularly well-suited for important living spaces. Arno belongs to a range of sophisticated armchairs, designed according to a range of geometrical patterns.

De Arno präsentiert sich als quadratischer Sessel mit lackierten Metallbeinen. Er ist mit einem hochwertigen, „maßgeschneiderten“ Bezug versehen, der ihn für edle Wohnbereiche besonders ideal macht. Arno gehört zu einer raffinierten Sesselfamilie mit unterschiedlichen geometrischen Formen.

Fr Arno est un fauteuil de forme carrée avec des petits pieds en métal verni. Il est réalisé avec un revêtement à la coupe « couture » de qualité qui le rend particulièrement adapté aux zones living importantes. Arno fait partie d'une ligne de fauteuils sophistiqués, déclinés dans différents langages géométriques.





Arno Mauro Lipparini



Bodo

Bodo è una poltrona girevole che permette di arredare con eleganza e comfort la propria casa grazie alla preziosa ricercatezza delle lavorazioni. È caratterizzata dalla forma mono volumetrica ed è impreziosita dall'inserito in pelle a contrasto.

En Bodo is a spinning armchair which allows you to furnish your house with elegance and comfort thanks to the attention to details. It features a mono-volumetric shape and is embellished by the contrasting leather insertion.

De Bodo ist ein drehbarer Sessel, der dank besonders gefragter Bearbeitungen das Heim mit Eleganz und Komfort einrichtet. Er besticht mit einer geschlossenen, voluminösen Form und einem dekorativen Einsatz aus kontrastfarbenem Leder.

Fr Bodo est un fauteuil pivotant qui permet de meubler avec élégance et confort l'habitation grâce aux précieuses finitions recherchées. Il est caractérisé par sa forme monovolumétrique et est enrichi d'une pièce en cuir souple contrastant.

Bodo Mauro Lipparini





Bodo Mauro Lipparini



Bruno

Una linea connotata da sobrietà progettuale, con echi e rimandi alla tradizione del design. La poltrona Bruno è caratterizzata dalla forma curva dello schienale e dal dettaglio dell'inserto in pelle a contrasto. Le gambe in metallo verniciato sono disponibili in varie colorazioni.

En A line which features sobriety, but is reminiscent of the designer tradition. The Bruno armchair features a curve-shaped backrest and a contrasting leather insert. The painted metal legs are available in different colours.

De Eine von Schlichtheit in der Gestaltung geprägte Linie, mit Erinnerungen und Verweisen aus der Designtradition. Der Sessel Bruno ist von einer kurvigen Rückenlehne und von einem Einsatz aus kontrastfarbenem Leder geprägt. Die lackierten Metallbeine sind in unterschiedlichen Farben erhältlich.

Fr Une ligne marquée par la sobriété de sa conception, qui fait écho et renvoie à la tradition du design. Le fauteuil Bruno est caractérisé par la forme incurvée du dossier et par le détail de la pièce en cuir souple contrastant. Les pieds en métal verni sont disponibles en différentes couleurs.

Bruno Mauro Lipparini





Bruno Mauro Lipparini



Blazer

La leggerezza come scelta progettuale, sia nelle linee graziose e gentili, sia nella base a slitta in metallo verniciato. Le forme sinuose e curvilinee della poltrona, disponibile con schienale alto o basso, ne esaltano la comodità e leggerezza e la rendono adatta a qualsiasi tipo di arredamento. È disponibile sia con rivestimento monocolore sia con rivestimento bicolore (diverso per la scocca e la seduta). Realizzata anche nella versione divanetto (Blazer Sofa).

En Lightness is the key feature of this project, as it is visible both in the gracious and gentle lines, and the metal painted sliding base. The sinuous and curvy shape of the armchair available with a high or low backrest highlight comfort and lightness and make it suitable to any kind of layout. It is also possible to choose a single-tone covering or a two-tone covering (for the seat and the frame). Also available in the sofa version (Blazer sofa).

De Leichtigkeit in der Gestaltung, sowohl in den zarten und sanften Linien, als auch beim Kufengestell aus lackiertem Metall. Die geschwungenen und kurvigen Formen des Sessels, der mit hoher und niedriger Rückenlehne erhältlich ist, betonen Komfort und Leichtigkeit und machen ihn für jede Einrichtung geeignet. Er ist sowohl mit einem unifarbigen Bezug als auch mit einem für das Gestell und die Sitzfläche unterschiedlichen Bezug erhältlich. Der Sessel ist auch als Sofa-Version (Blazer Sofa) verfügbar.

Fr La légèreté comme choix de conception, à la fois dans les lignes gracieuses et plaisantes et dans la base coulissante en métal verni. Les formes sinueuses et incurvées du fauteuil, disponible avec dossier haut et bas, exaltent le confort et la légèreté et le rendent adapté à tout type d'ameublement. Il est disponible avec un revêtement en teinte unie ou bicolore (revêtement différent pour la coque et l'assise). Réalisé également dans la version petit canapé (Blazer Sofa).

Blazer Mauro Lipparini





Blazer Mauro Lipparini





Blazer Sofa Mauro Lipparini

Nikos ego

Nikos ego, una poltrona dal design morbido e accattivante che invita al relax. È particolarmente comoda e accogliente grazie alla soffice imbottitura in piuma e alla dotazione di un cuscino ergonomico poggiatesta che sostiene la zona lombare. La famiglia di sedute Nikos comprende inoltre un divanetto (Nikos Sofa) e una poltrona bassa (Nikos low).

En Nikos ego, an armchair with a soft and captivating design, invites you to relax. It is extremely comfortable and welcoming thanks to the soft feather padding and the presence of an ergonomic back support cushion which supports the lower back area. The Nikos seating collection also includes a sofa (Nikos Sofa) and a low armchair (Nikos low).

De Nikos ego, ein Sessel mit weichen Linien und ansprechendem Design lädt zum Entspannen ein. Dank der weichen Daunepolsterung und einem ergonomischen Nierenkissen, das den Lendenbereich stützt, ist er besonders bequem und gemütlich. Die Sitzmöbelkollektion Nikos umfasst außerdem ein Sofa (Nikos Sofa) und einen niedrig gehaltenen Sessel (Nikos low).

Fr Nikos ego est un fauteuil au design souple et attrayant qui invite à la détente. Il est particulièrement commode et accueillant grâce au rembourrage moelleux en plume et à son coussin ergonomique pour les reins qui soutient la région lombaire. La famille de sièges Nikos inclut également un petit canapé (Nikos Sofa) et un fauteuil bas (Nikos low).



Nikos ego, Nikos low Sergio Bicego



Nikos ego Sergio Bicego





Nikos Sofa Sergio Bicego

Alfie

Un oggetto che rivisita in chiave contemporanea un classico dell'arredamento, che diventa così un pezzo di design per soddisfare il desiderio di comfort e l'amore per le linee pulite e moderne. Alfie è una poltrona relax fortemente caratterizzata dal forte impatto visivo della struttura in metallo. È disponibile anche nella versione (Alfie Arm), con morbidi braccioli. Il pouf abbinato è un optional che permette di aumentare la comodità della seduta.

En An object which revisits a classic furnishing feature in a contemporary way, becoming a designer piece which satisfies the need for comfort and the love for clean, modern lines. Alfie is a relaxing armchair which has a strong visual impact thanks to its metal structure. It is also available in its Alfie Arm version, with soft armrests. The combined pouf is an optional addition which allows you to increase the comfort of the seat.

De Ein neu interpretierter Einrichtungsklassiker, der zum Designerstück wird und so den Wunsch nach Komfort und die Liebe zu klaren und modernen Linien erfüllt. Alfie ist ein Relaxsessel, dessen Metallgestell eine starke optische Wirkung erzeugt. Er ist auch in der Version (Alfie Arm) mit weichen Armlehnen erhältlich. Der kombinierbare Sitzpuff ist ein Zusatzaccessoire, das den Sessel noch bequemer macht.

Fr Un objet qui revisite dans un esprit contemporain un classique de l'ameublement, qui devient ainsi une pièce de design en mesure de répondre au désir de confort et à l'amour pour les lignes épurées et modernes. Alfie est un fauteuil relax fortement caractérisé par sa structure en métal au fort impact visuel. Il est également disponible dans la version Alfie Arm, avec de moelleux accoudoirs. Le pouf coordonné est une option qui permet d'augmenter la commodité du siège.



Alfie Arm Giuseppe Viganò





Alfie Giuseppe Viganò

Structure Armchair

Un'anima in metallo definisce la logica progettuale di questa poltrona: la struttura talvolta viene messa in evidenza, mentre in altri casi è parzialmente nascosta, conferendo un aspetto assolutamente informale, con effetti estetici originali e personalizzati dalla scelta degli abbinamenti di colori e materiali. Abbinabile a Structure Sofa.

En A metal core defines the project logic behind this armchair: the structure is sometimes highlighted, other times partially hidden, conferring a completely informal vibe, with original aesthetic effects, personalisable by the choice of colour and combination of materials. It can be combined with Structure Sofa.

De Ein Metallgestell bestimmt das Design dieses Sessels: Zum Teil als Blickfang in Szene gesetzt, zum Teil kaum zu sehen, verleiht es dem Sessel einen vollkommen informellen Look, wobei die Auswahl der Farb- und Materialzusammenstellungen für originelle und individuelle optische Wirkung sorgt. Mit Structure Sofa kombinierbar.

Fr Une âme en métal définit la logique conceptuelle de ce fauteuil : parfois la structure est mise en valeur; alors que dans d'autres cas elle est partiellement cachée, donnant ainsi un aspect totalement informel, avec des effets originaux et personnalisés par le choix des mariages de couleurs et de matériaux. Il peut être coordonné à Structure Sofa.

Structure Armchair Alain Gilles





Structure Armchair Alan Gilles

Lars

Connotate da un'immagine aerea e quasi sospesa, le poltrone Lars e Lars Plus trasmettono un'idea di comfort e relax. I braccioli dolcemente inclinati verso l'esterno insieme ai cuscini creano un effetto di forme in movimento. Abbinabili agli omonimi divani, Lars e Lars Plus.

En The key feature of Lars and Lars Plus is the raised above the floor, almost suspended vibes they convey, which exude comfort and relaxation. The armrests are gently inclined outwardly and with the cushions create the effect of shapes in movement. They can be combined with the sofas sharing the same name, Lars and Lars Plus.

De Die Sessel Lars und Lars Plus, die von einem luftigen und beinahe schwebenden Design geprägt sind, vermitteln ein Gefühl von Komfort und Entspannung. Die Armlehnen sind sanft nach außen geneigt und Kissen zusammen mit den schaffen einen Effekt von sich bewegenden Formen. Mit den gleichnamigen Sofas Lars und Lars Plus kombinierbar.

Fr Évoquant une image aérienne, les fauteuils Lars et Lars Plus transmettent une idée de confort et de détente. Les accoudoirs, légèrement inclinés vers l'extérieur, et les coussins créent un effet de forme en mouvement. Coordinés aux canapés homonymes, Lars et Lars Plus.

Lars Giuseppe Viganò



Paraiso

Una poltrona rigorosa, con linee e forme nettamente definite: Paraiso ha un gusto spiccatamente contemporaneo e grazie ai suoi volumi equilibrati si adatta ad ambienti di diverse dimensioni e stili, dando piena soddisfazione al senso estetico e al desiderio di comfort. Abbinabile all'omonimo divano Paraiso.

En A rigorous armchair, with clearly-defined lines and shapes: Paraiso has a decidedly contemporary feel and, thanks to its balanced volumes, it adapts to environments of different sizes and styles, fully satisfying aesthetic need and desire for comfort. It can be combined with the Paraiso sofa of the same name.

De Ein präziser Sessel mit genau bestimmten Linien und Formen: Paraiso präsentiert sich im eindeutig modernen Stil und passt sich dank der harmonischen Proportionen an unterschiedliche Raumgrößen und Einrichtungsstile an, um so ganz Geschmacksansprüchen und Komfortwünschen gerecht zu werden. Mit dem gleichnamigen Sofa Paraiso kombinierbar.

Fr Un fauteuil rigoureux, avec des lignes et des formes nettement définies : Paraiso possède un look fortement contemporain et, grâce à ses volumes équilibrés, il s'adapte aux pièces de différentes dimensions et styles, satisfaisant ainsi pleinement le sens esthétique et le désir de confort. Coordiné au canapé homonyme Paraiso.

Paraiso Sergio Bicego





Paraiso Sergio Bicego





Paraiso Sergio Bicego





I POUF BONALDO,
ORDINE E RELAX
Un elemento d'arredo sempre più
presente nelle case contemporanee:
i pouf, disponibili in diversi modelli,
finiture e rivestimenti rappresentano
un oggetto dalla funzionalità variabile.
Può essere un contenitore di servizio,
una seduta informale o servire come
piano su cui appoggiare le gambe.
In ogni caso è un oggetto che viene
utilizzato per rendere più comodi
i gesti d'ogni giorno.

Pouf. Pouf. Pouf. Pouf



En THE BONALDO POUFS: ORDER AND RELAXATION
A furnishing feature which is ever more present in contemporary houses: poufs available in different models, finishing and coverings are objects which have many functions. It can serve as a container, an informal seat or be used as a surface on which to place one's legs. In any case, it is an object that is used to make daily activities more comfortable.

De BONALDO SITZPUFFS, ORDNUNG UND ENTSPANNUNG
Ein in den modernen Heimen immer häufiger anzutreffendes Einrichtungselement: Die Sitzpuffs, die in verschiedenen Modellen, Bearbeitungen und Bezügen verfügbar sind, stellen einen Gegenstand mit verschiedener Funktionalität dar. So können sie als nützliche Aufbewahrungsmöglichkeit, informelle Sitzgelegenheit oder als Fläche zur Beinablage dienen. Auf jeden Fall ist es ein Objekt, das verwendet wird, um das Alltagsleben bequemer zu gestalten.

Fr LES POUFS BONALDO, ORDRE ET DÉTENTE
Un élément d'ameublement de plus en plus présent dans les habitations contemporaines : les poufs, disponibles dans différents modèles, finitions et revêtements, représentent un objet dont la fonction peut varier. Il peut s'agir d'un rangement de service, d'un siège informel ou servir de plan sur lequel poser les jambes. Dans tous les cas, cet objet est utilisé pour rendre plus commodes les gestes de tous les jours.

Secret

Secret è una serie di pouf dalle morbide forme troncopiramidali che, grazie all'aspetto discreto, si inseriscono con facilità nei diversi ambienti, fungendo sia da seduta sia da pratico contenitore. I pouf Secret sono proposti in versione bicolore o in tinta unita; le cuciture al vivo ribattute esaltano ed enfatizzano gli spigoli.

En Secret is a series of poufs with soft truncated pyramid shapes which, thanks to their discreet appearance, fit the different environments with ease, acting both as a seat and a practical container. The Secret poufs are available in two colours or monochrome: the raw-edge stitching highlights the edges.

De Secret ist eine Reihe pyramidenstumpfförmiger Sitzpuffs mit weichen Kanten, die sich dank ihrer bescheidenen Optik in jedes Umfeld einfügen und sowohl als Sitzgelegenheit, als auch als praktische Aufbewahrungsmöglichkeit dienen. Die Puffs Secret sind in zweifarbig oder einfarbig Ausführung erhältlich. Die sichtbaren Kappnähte betonen die Kanten noch zusätzlich.

Fr Secret est une série de poufs aux douces formes troco-pyramidales qui, grâce à leur aspect discret, s'intègrent facilement aux différentes pièces, faisant ainsi office de siège ou de rangement pratique. Les poufs Secret sont proposés en version bicolore ou en teinte unie ; les coutures apparentes rabattues exaltent et soulignent les angles.



Secret Mauro Lipparini

Kernel

Sono morbidi e informali, agili ed estroversi: i pouf Kernel, disponibili in tre diverse misure, interpretano in modo originale l'esigenza di comodità, ideali per ogni angolo della casa.

En Soft and informal, agile and extroverted: the Kernel poufs are available in three different sizes and they each interpret the common need for comfort in a unique way for you to enjoy in every part of the house.

De Sie sind weich, informell, flexibel und extravertiert: Die Sitzpuffs Kernel, die in drei verschiedenen Größen erhältlich sind, interpretieren auf originelle Weise das allgemeine Komfortbedürfnis für jede Ecke des Heims geeignet.

Fr Doux et informels, agiles et extrovertis : les poufs Kernel, disponibles en trois dimensions différentes, interprètent de manière originale l'exigence commune de commodité, pour se sentir bien dans chaque coin de l'habitation.



Kernel



Informazioni tecniche. Technical information.
Technische Hinweise. Informations techniques.

Alvar Sofa	P.	266	Lars Plus	P.	284, 311
Alfie, Alfie Arm	P.	306	Lock	P.	312
Arno	P.	307	Lovy	P.	302
Avarit	P.	268	Nikos ego, Nikos low, Nikos Sofa	P.	313
Bandy, Bandy Plus	P.	303	Papillon, Papillon XL	P.	304
Blazer, Blazer Sofa	P.	308	Paraiso	P.	286, 314
Bodo	P.	309	Paraiso Plus	P.	288
Bruno	P.	310	Peanut Air	P.	290
Cave	P.	270	Peanut B	P.	292
Colors	P.	272	Pierrot, Pierrot King	P.	305
Coral	P.	274	Secret	P.	317
Gossip	P.	276	Skid	P.	296
Kernel	P.	316	Slab Plus	P.	298
Hiro	P.	278	Structure Armchair	P.	315
Lars	P.	280, 311	Structure Sofa	P.	300

ALVAR SOFA



1 RIVESTIMENTO / COVER / BEZUG / REVÊTEMENT

RIVESTIMENTO	UPHOLSTERY	BEZUG	REVÊTEMENT
tessuto	fabric	Stoff	tissu

2 PIEDI / FEET / FÜÙE / PIEDS

METALLO VERNICIATO OPACO

1. grigio antracite	2. tortora	3. amaranto	4. bianco	5. nero	6. marrone
---------------------	------------	-------------	-----------	---------	------------

MAT PAINTED METAL	LACKIERT MATT METAL	METAL VERNI OPAQUE
1. anthracite grey	1. Anthrazitgrau	1. gris anthracite
2. dove grey	2. Taubengrau	2. gris tourterelle
3. amaranth	3. Amaranth	3. amarante
4. white	4. Weiss	4. blanc
5. black	5. Schwarz	5. noir
6. brown	6. Braun	6. marron

DIMENSIONI / DIMENSIONS / GRÖÙSEN / DIMENSIONS

Divano / Sofa / Sofa / Canapé Angolare dx o sx / Corner sofa right or left / Ecksofa recht oder links / Canapé d'angle droite ou gauche Terminale dx o sx / End section right or left / Endteil recht oder links / Élément terminal droite ou gauche Chaise longue dx o sx / right or left / recht oder links / droite ou gauche

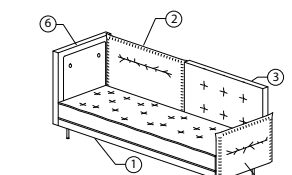
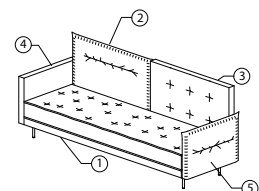

Sinistra / left / Links / gauche

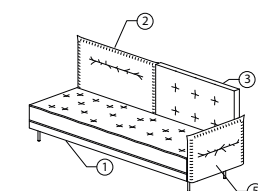

Destra / right / Recht / droite

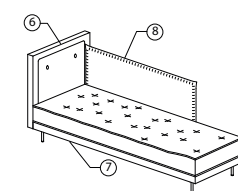

Destra / right / Recht / droite

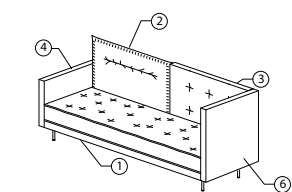

Destra / right / Recht / droite

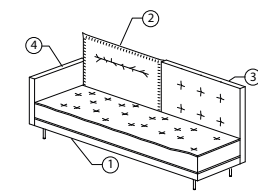

Sinistra / left / links / gauche

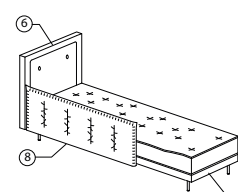

Sinistra / left / links / gauche

Base / Base / Gestell / Base

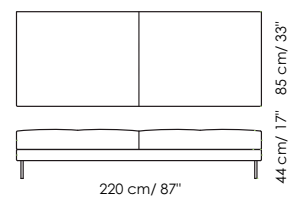
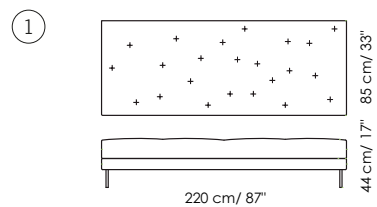

Schienale sx / left backrest / Links Rückenlehne / dossier gauche

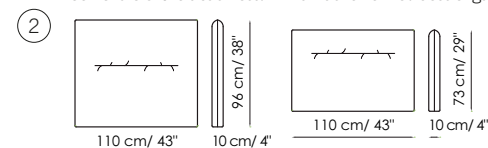

Schienale dx / right backrest / Rechts Rückenlehne / dossier droit

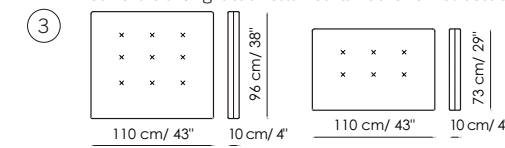

Bracciolo sx / left armrest / Links Armlehne / accoudoir gauche

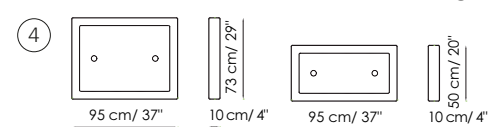

Bracciolo dx / right armrest / Rechts Armlehne / accoudoir droit

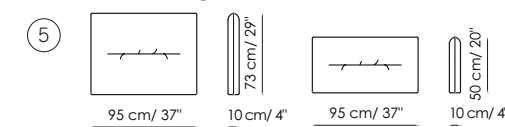

Schienale angolare / corner backrest / Eck Rückenlehne / dossier d'angle

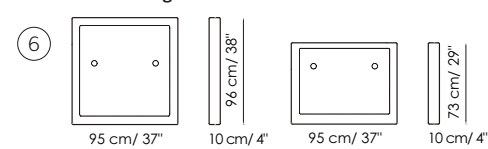

Chaise longue Base / Base / Gestell / Base

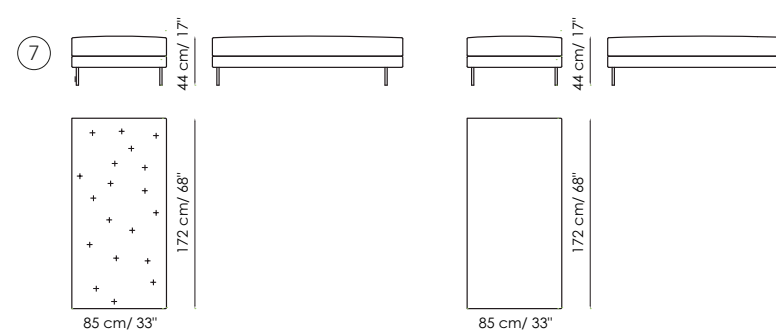

Chaise longue Bracciolo / armrest / Armlehne / accoudoir

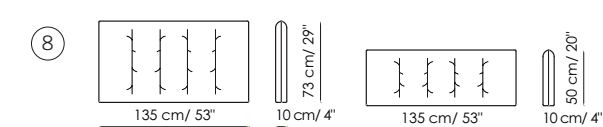

Cuscino / cushion / Kissen / coussin

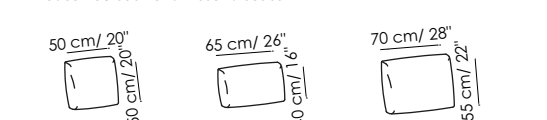

COMPOSIZIONE / COMBINATION / KOMBINATION / COMPOSITION

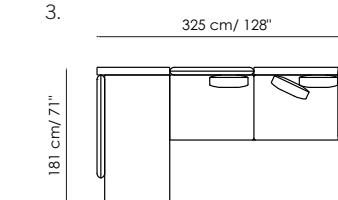
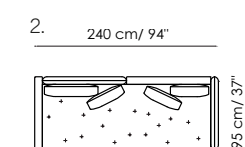
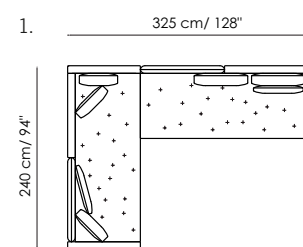

Pag. 138, 139, 140-141:

- SA70 piedi tortora / dove grey feet / Taubengrau FüÙe / pieds gris tourterelle
- N°2 FAL2
- 1. base con cuscino trapuntato a seduta singola / base with quilted single seat cushion / Basis mit gestepptem Kissen und einzelner Sitz / base avec coussin matelassé et une assise unique - MB91, piedi antracite / anthracite grey feet / Anthrazitgrau FüÙe / pieds gris anthracite
- N°1 FALC
- 3. Schienale dx / right backrest / Rechts Rückenlehne / dossier droit - h 73 cm / 29"
- N°2 FALA
- 2. Schienale sx / left backrest / Links Rückenlehne / dossier gauche - h 73 cm / 29"
- N°1 FALC
- 4. Bracciolo sx / left armrest / Links Armlehne / accoudoir gauche - h 50 cm / 20"
- N°1 FALM
- 6. Schienale angolare / corner backrest / Eck Rückenlehne / dossier d'angle - h 73 cm / 29"
- N°1 FALH
- 5. Bracciolo dx / right armrest / Rechts Armlehne / accoudoir droit - h 73 cm / 29"
- N°2 CUP5 - Cuscino 70x55 / cushion / Kissen / coussin - SA70
- N°1 CUP7 - Cuscino 65x40 / cushion / Kissen / coussin - 9B03
- N°1 CUP7 - Cuscino 65x40 / cushion / Kissen / coussin - SA70
- N°2 CUP6 - Cuscino 50x50 / cushion / Kissen / coussin - SA70
- N°1 CUP6 - Cuscino 50x50 / cushion / Kissen / coussin - 9B03

Pag. 142, 143, 144-145:

- N°2 FAL2
- 1. base con cuscino trapuntato a seduta singola / base with quilted single seat cushion / Basis mit gestepptem Kissen und einzelner Sitz / base avec coussin matelassé et une assise unique - MB91, piedi antracite / anthracite grey feet / Anthrazitgrau FüÙe / pieds gris anthracite
- N°1 FALC
- 4. Bracciolo sx / left armrest / Links Armlehne / accoudoir gauche - h 50 cm / 20" - MB91
- N°1 FALG
- 5. Bracciolo dx / right armrest / Rechts Armlehne / accoudoir droit - h 50 cm / 20" - MB91
- N°1 FALC
- 3. Schienale dx / right backrest / Rechts Rückenlehne / dossier droit - h 73 cm / 29" - MB62
- N°1 FALB
- 2. Schienale sx / left backrest / Links Rückenlehne / dossier gauche - h 96 cm / 38" - MB62
- N°1 CUP5 - Cuscino 70x55 / cushion / Kissen / coussin - MB62
- N°1 CUP6 - Cuscino 50x50 / cushion / Kissen / coussin - MB91
- N°2 CUP6 - Cuscino 50x50 / cushion / Kissen / coussin - MB88

Pag. 146-147, 148, 149:

- N°1 FAL3
- 7. base con cuscino liscio a seduta singola / base with smooth single seat cushion / Basis mit glatter und einzelner Sitz / base avec coussin lisse et une assise unique - SA24, piedi antracite / anthracite grey feet / Anthrazitgrau FüÙe / pieds gris anthracite
- N°1 FALØ
- 1. base con cuscino liscio a doppia seduta / base with smooth double seat cushion / Basis mit glatter Doppelsitzkissen / base avec coussin lisse double assise - SA22, piedi antracite / anthracite grey feet / Anthrazitgrau FüÙe / pieds gris anthracite
- N°1 FALP
- 8. Bracciolo / armrest / Armlehne / accoudoir - h 50 cm / 20" - SA22
- N°1 FALM
- 6. Schienale angolare / corner backrest / Eck Rückenlehne / dossier d'angle - h 73 cm / 29" - SA22
- N°1 FALC
- 3. Schienale dx / right backrest / Rechts Rückenlehne / dossier droit - h 73 cm / 29" - SA24
- N°1 FALA
- 2. Schienale sx / left backrest / Links Rückenlehne / dossier gauche - h 73 cm / 29" - SA24
- N°1 FALG
- 5. Bracciolo dx / right armrest / Rechts Armlehne / accoudoir droit - h 50 cm / 20" - SA32
- N°1 CUP6 - Cuscino 50x50 / cushion / Kissen / coussin - SA22
- N°2 CUP6 - Cuscino 50x50 / cushion / Kissen / coussin - SA32

AVARIT



1 RIVESTIMENTO / COVER / BEZUG / REVÊTEMENT

RIVESTIMENTO pelle tessuto	UPHOLSTERY leather fabric	BEZUG Leder Stoff	REVÊTEMENT cuir souple tissu
---	--	--------------------------------	---

2 PIEDI / FEET / FÜÙE / PIEDS

METALLO VERNICIATO OPACO



MAT PAINTED METAL

1. anthracite grey
2. dove grey
3. brown
4. amaranth
5. white
6. black

LACKIERT MATT METAL

1. Anthrazitgrau
2. Taubengrau
3. Braun
4. Amaranth
5. Weiss
6. Schwarz

METAL VERNI OPAQUE

1. gris anthracite
2. gris tourterelle
3. marron
4. amarante
5. blanc
6. noir

DIMENSIONI / DIMENSIONS / GRÖÙEN / DIMENSIONS

Divano / Sofa / Sofa / Canapé 187

207

227

242

Divano 282 / variante A / version A / Variante A / version A

Divano 282 / variante B / version B / Variante B / version B

Divano 322 / variante A / version A / Variante A / version A

Divano 322 / variante B / version B / Variante B / version B

Terminale dx o sx / End section right or left / Endteil recht oder links / Élément terminal droite ou gauche 201

216

256

Angolo / Corner / Ecke / Angle

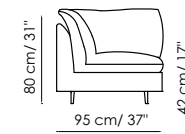

Centrale / Center section / Mittelteil / Élément central

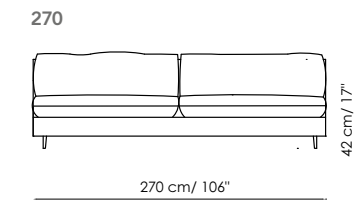
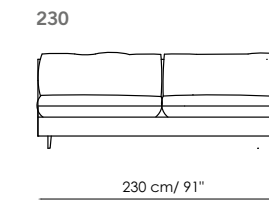
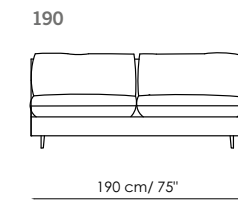
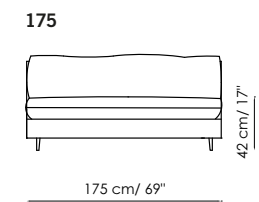
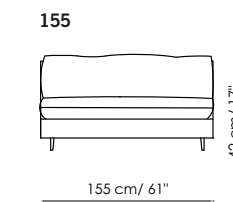
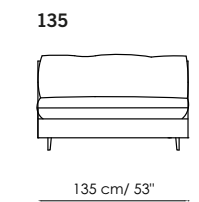
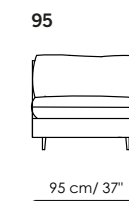
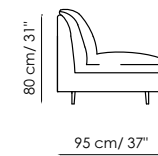

Chaise longue dx o sx / right or left / recht oder links / droite ou gauche

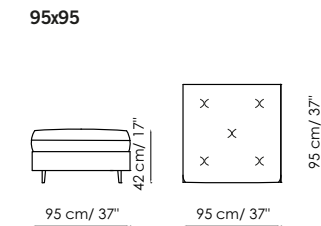
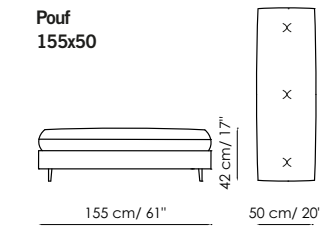
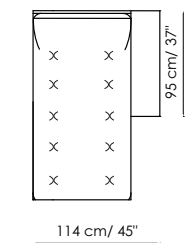
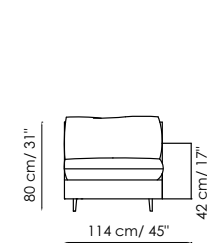

Isola dx o sx / right or left / recht oder links / droite ou gauche

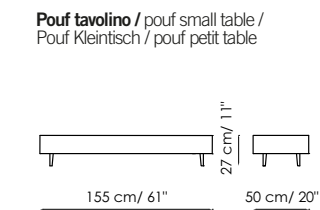
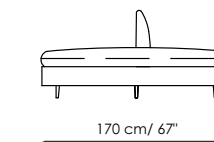
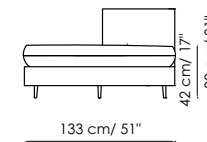

Sinistra / left / links / gauche

COMPOSIZIONE / COMBINATION / KOMBINATION / COMPOSITION

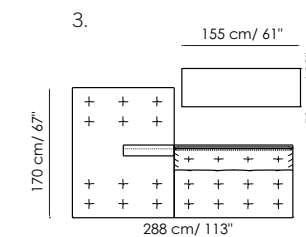
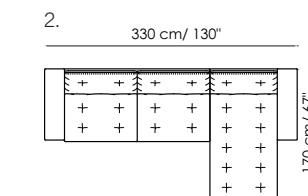
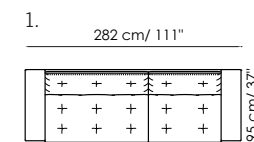

Pag. 151, 152 - 153:

N°1 Divano 282 - variante B / Sofa 282 - version B / Sofa 282 - Variante B / Canapé 282 - version B

CAVF - cuscini / cushions / Kissen / coussins - 93M

WAVF - struttura / frame / Struktur / structure - NO1, piedi antracite / anthracite grey feet / Anthrazitgrau FüÙe / pieds gris anthracite

Pag. 154-155, 156, 157:

SA38, piedi antracite / anthracite grey feet / Anthrazitgrau FüÙe / pieds gris anthracite

N°1 FAXD - Terminale 216 sx / End section sofa left / Sofa Endteil links / Élément terminal gauche

N°1 FAVI - Chaise longue 114x170 dx / right / Recht / droit

Pag. 158-159, 160, 161:

N°1 FAVL - Isola sx / left / links / gauche - E59, piedi antracite / anthracite grey feet / Anthrazitgrau FüÙe / pieds gris anthracite

N°1 FAV4 - Centrale 155 / Center section / Mittelteil / Élément central - E59, piedi antracite / anthracite grey feet / Anthrazitgrau FüÙe / pieds gris anthracite

N°1 OVA2 - pouf tavolino / pouf small table / Pouf Kleintisch / pouf petit table - 96Z, piedi antracite / anthracite grey feet / Anthrazitgrau FüÙe / pieds gris anthracite

CAVE



1

RIVESTIMENTO / COVER / BEZUG / REVÊTEMENT

RIVESTIMENTO
pelle
tessuto

UPHOLSTERY
leather
fabric

BEZUG
Leder
Stoff

REVÊTEMENT
cuir souple
tissu

2

PIEDI / FEET / FÜÙE / PIEDS

METALLO VERNICIATO OPACO



MAT PAINTED METAL

1. anthracite grey
2. dove grey
3. brown
4. amaranth
5. white
6. black

LACKIERT MATT METAL

1. Anthrazitgrau
2. Taubengrau
3. Braun
4. Amaranth
5. Weiss
6. Schwarz

METAL VERNI OPAQUE

1. gris anthracite
2. gris tourterelle
3. marron
4. amarante
5. blanc
6. noir

DIMENSIONI / DIMENSIONS / GRÖÙSEN / DIMENSIONS

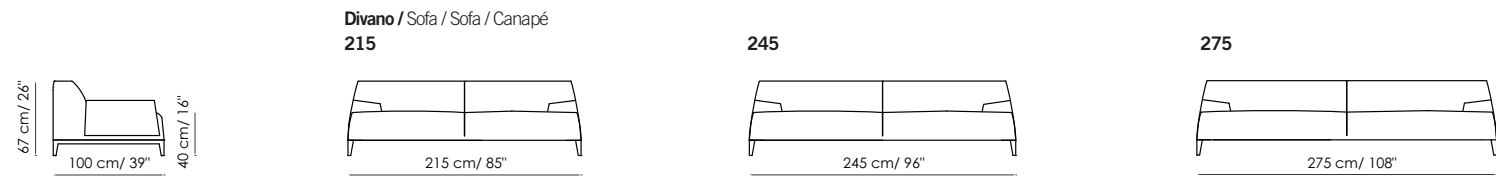

Divano / Sofa / Sofa / Canapé
215

245

275

Terminale dx o sx / End section right or left / Endteil recht oder links / Élément terminal droite ou gauche

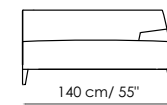

Centrale / Center section / Mittelteil / Élément central

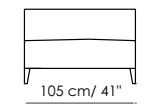

Chaise longue dx o sx / right or left / recht oder links / droite ou gauche

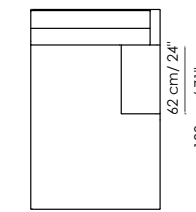
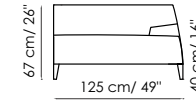

Penisola dx o sx / right or left / recht oder links / droite ou gauche

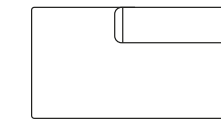

100 cm / 39"

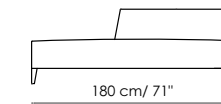

180 cm / 71"

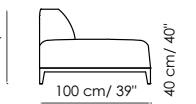

100 cm / 39"

Pouf

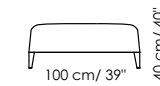

100 cm / 39"

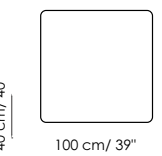

100 cm / 39"

Bracciolo alto / High armrest / Hohe Armlehne / Accoudoir haut

30 cm / 12"



45 cm / 18"



65 cm / 26"



39 cm / 15"

Bracciolo cuoio / Emery leather armrest / Kernleder Armlehne / Accoudoir cuir



65 cm / 26"

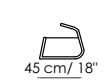

45 cm / 18"



36 cm / 14"

Bracciolo cuoio Porta oggetti / Emery leather armrest with holder / Kernleder Armlehne Objektträger / Accoudoir cuir avec porte - objects



65 cm / 26"



45 cm / 18"

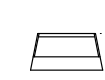

36 cm / 14"

COMPOSIZIONE / COMBINATION / KOMBINATION / COMPOSITION

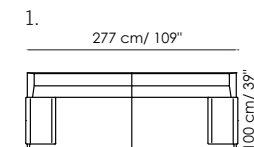

1. 277 cm / 109"

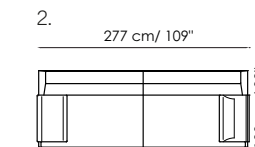

2. 277 cm / 109"

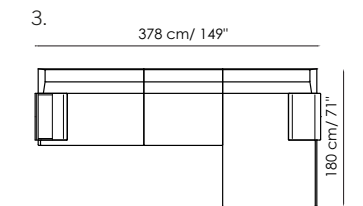

3. 378 cm / 149"

Pag. 178, 179:

N°1 FCA7 - Divano 275 / Sofa / Sofa / Canapé - **M84**, piedi tortora / dove grey feet / Taubengrau FüÙe / pieds gris tourterelle

Pag. 180-181:

N°1 FCA7 - Divano 275 / Sofa / Sofa / Canapé - **M84**, piedi tortora / dove grey feet / Taubengrau FüÙe / pieds gris tourterelle
N°1 SPCAVE3 - Bracciolo cuoio / Emery leather armrest / Kernleder Armlehne / Accoudoir cuir - **color cuoio** / brown / Braun / marron

Pag. 182-183, 184, 185:

N°1 FCBS - Terminale 140 sx / End section sofa left / Sofa Endteil links / Élément terminal gauche - **98J**, piedi antracite / anthracite grey feet / Anthrazitgrau FüÙe / pieds gris anthracite
N°1 SPCAVE5 - Bracciolo cuoio Porta oggetti / Emery leather armrest with holder / Kernleder Armlehne Objektträger / Accoudoir cuir avec stoccage - **color antracite** / anthracite grey / Anthrazitgrau / gris anthracite
N°1 FCA4 - Centrale 105 / Center section / Mittelteil / Élément central - **98J**, piedi antracite / anthracite grey feet / Anthrazitgrau FüÙe / pieds gris anthracite
N°1 ELA5 - Chaise longue 125x180 dx / right / Recht / droite - **98J**, piedi antracite / anthracite grey feet / Anthrazitgrau FüÙe / pieds gris anthracite
N°1 SPCAVE1 - Bracciolo alto / Armrest / Armlehne / Accoudoir - **98J**

COLORS



1 RIVESTIMENTO / COVER / BEZUG / REVÊTEMENT

RIVESTIMENTO pelle tessuto	UPHOLSTERY leather fabric	BEZUG Leder Stoff	REVÊTEMENT cuir souple tissu
---	--	--------------------------------	---

2 FASCIA / BAND / STREIFEN / BANDE
solo versione tessuto / only fabric version / nur Stoffvariante / seulement version en tissu

disponibile in vari tessuti (vedere listino)	available in many fabrics (see price list)	verfügbar in mehreren Stoff varianten (siehe Preisliste)	disponible dans plusieurs tissus (voir liste des prix)
---	---	--	---

3 PIEDI / FEET / FÜßE / PIEDS

METALLO VERNICIATO OPACO

1. grigio antracite	2. tortora	3. marrone	4. amaranto	5. bianco	6. nero
---------------------	------------	------------	-------------	-----------	---------

METALLO FINITURA

7. cromato	8. black nickel	9. bronzo rame
------------	-----------------	----------------

MAT PAINTED METAL 1. anthracite grey 2. dove grey 3. brown 4. amaranth 5. white 6. black	LACKIERT MATT METAL 1. Anthrazitgrau 2. Taubengrau 3. Braun 4. Amaranth 5. Weiss 6. Schwarz	METAL VERNI OPAQUE 1. gris anthracite 2. gris tourterelle 3. marron 4. amarante 5. blanc 6. noir
METAL FINISH 7. chrome 8. black nickel 9. copper bronze	METALL AUSFÜHRUNG 7. Verchromt 8. Schwarz vernickelt 9. Kupferbronze	FINITION MÉTAL 7. chromé 8. noir nickelé 9. bronze cuivre

DIMENSIONI / DIMENSIONS / GRÖßEN / DIMENSIONS
PROFONDITÀ 90 / DEPTH 90 / TIEFE 90 / PROFONDEUR 90

Divano / Sofa / Sofa / Canapé 180 60 cm / 24" 180 cm / 71" 78 cm / 31" 90 cm / 35" 58 cm / 23" 43 cm / 17"	210 75 cm / 30" 210 cm / 83" 78 cm / 31" 90 cm / 35" 58 cm / 23" 43 cm / 17"	240 90 cm / 35" 240 cm / 94" 78 cm / 31" 90 cm / 35" 58 cm / 23" 43 cm / 17"
Terminale dx o sx / End section right or left / Endteil recht oder links / Élément terminal droite ou gauche 165 60 cm / 24" 165 cm / 65" 78 cm / 31" 90 cm / 35" 58 cm / 23" 43 cm / 17"	195 75 cm / 30" 195 cm / 77" 78 cm / 31" 90 cm / 35" 58 cm / 23" 43 cm / 17"	225 90 cm / 35" 225 cm / 89" 78 cm / 31" 90 cm / 35" 58 cm / 23" 43 cm / 17"
Angolare dx o sx / Corner sofa right or left / Eckssofa recht oder links / Canapé d'angle droite ou gauche 195 75 cm / 30" 195 cm / 77" 50 cm / 20" 78 cm / 31" 90 cm / 35" 58 cm / 23" 43 cm / 17"	225 90 cm / 35" 225 cm / 89" 50 cm / 20" 78 cm / 31" 90 cm / 35" 58 cm / 23" 43 cm / 17"	

Chaise longue dx o sx / right or left / recht oder links / droite ou gauche 105x150 150 cm / 59" 78 cm / 31" 90 cm / 35" 105 cm / 41" 86 cm / 34" 150 cm / 59"	105x195 90 cm / 35" 195 cm / 77" 78 cm / 31" 90 cm / 35" 105 cm / 41" 130 cm / 51" 195 cm / 77" 60 cm / 24"	Pouf 90x90 90 cm / 35" 90 cm / 35" 43 cm / 17"
---	--	--

DIMENSIONI / DIMENSIONS / GRÖßEN / DIMENSIONS
PROFONDITÀ 105 / DEPTH 105 / TIEFE 105 / PROFONDEUR 105

Divano / Sofa / Sofa / Canapé 210 75 cm / 30" 210 cm / 83" 78 cm / 31" 105 cm / 41" 43 cm / 17" 58 cm / 23"	240 90 cm / 35" 240 cm / 94" 78 cm / 31" 90 cm / 35" 58 cm / 23"	Terminale dx o sx / End section right or left / Endteil recht oder links / Élément terminal droite ou gauche 225 90 cm / 35" 225 cm / 89" 78 cm / 31" 105 cm / 41" 43 cm / 17" 58 cm / 23"	Angolare dx o sx / Corner sofa right or left / Eckssofa recht oder links / Canapé d'angle droite ou gauche 225 90 cm / 35" 75 cm / 30" 225 cm / 89" 78 cm / 31" 105 cm / 41" 43 cm / 17" 58 cm / 23"	Chaise longue dx o sx / right or left / recht oder links / droite ou gauche 120x180 116 cm / 46" 180 cm / 71" 105 cm / 41" 120 cm / 47"
Divano angolare dx o sx / Corner sofa sofa or left / Eckssofa recht oder links / Canapé d'angle droite ou gauche 240 90 cm / 35" 75 cm / 30" 240 cm / 94" 78 cm / 31" 105 cm / 41" 43 cm / 17" 58 cm / 23"				

COMPOSIZIONE / COMBINATION / KOMBINATION / COMPOSITION

1. 330 cm / 130" 195 cm / 77"	2. 240 cm / 94" 105 cm / 41"
3. 240 cm / 94" 90 cm / 35"	4. 330 cm / 130" 240 cm / 94"

Pag. 29, 30-31:
MA36 (rivestimento / cover / Bezug / revêtement) + **MA82** (fascia / band / streifen / bande) piedi marroni / brown feet / Braun Füße / pieds marron
N°1 FCL5 - Terminale 225 sx profondità 90 / End section sofa left depth 90 / Sofa Endteil links tiefe 90 / Élément terminal gauche profondeur 90
N°1 ECL1 - Chaise longue 105x195 dx profondità 90 / depth 90 right / Tiefe 90 Recht / profondeur 90 droit

Pag. 32, 33:
SA80 (rivestimento / cover / Bezug / revêtement) + **SA76** (fascia / band / streifen / bande) piedi neri / black feet / Schwarz Füße / pieds noir
N°1 FCM1
Divano 240 profondità 105 / Sofa depth 105 / Sofa Tiefe 105 / Canapé profondeur 105

N°1 FCL1
Divano 240 profondità 90 / Sofa depth 90 / Sofa Tiefe 90 / Canapé profondeur 90
Pag. 34-35:
97T (rivestimento / cover / Bezug / revêtement) + **SA60** (fascia / band / streifen / bande), piedi neri / black feet / Schwarz Füße / pieds noir
Pag. 36-37:
SA72 piedi neri / black feet / Schwarz Füße / pieds noir

Pag. 38-39:
SA80 (rivestimento / cover / Bezug / revêtement) + **SA76** (fascia / band / streifen / bande) piedi neri / black feet / Schwarz Füße / pieds noir
N°1 FCM7 - Divano angolare 240 dx profondità 105 / Corner sofa right depth 105 / Eckssofa Recht Tiefe 105 / Canapé d'angle droit profondeur 105
N°1 FCLA - Terminale angolare 225 dx profondità 90 / Corner sofa right depth 90 / Eckssofa Recht Tiefe 90 / Canapé d'angle droit profondeur 90

CORAL



1. RIVESTIMENTO / COVER / BEZUG / REVÊTEMENT

RIVESTIMENTO
pelle
tessuto

UPHOLSTERY
leather
fabric

BEZUG
Leder
Stoff

REVÊTEMENT
cuir souple
tissu

2. PIEDI / FEET / FÜÙE / PIEDS

METALLO VERNICIATO OPACO



MAT PAINTED METAL

1. anthracite grey
2. dove grey
3. brown
4. amaranth
5. white
6. black

LACKIERT MATT METAL

1. Anthrazitgrau
2. Taubengrau
3. Braun
4. Amaranth
5. Weiss
6. Schwarz

METAL VERNI OPAQUE

1. gris anthracite
2. gris tourterelle
3. marron
4. amarante
5. blanc
6. noir

DIMENSIONI / DIMENSIONS / GRÖÙEN / DIMENSIONS



Terminale dx o sx / End section right or left / Endteil recht oder links / Élément terminal droite ou gauche
180

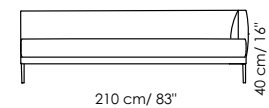
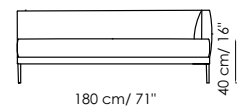
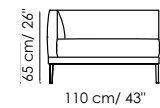

Pouf

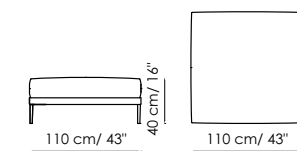

Cuscino / cushion / Kissen / coussin

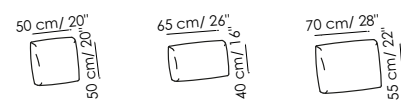

COMPOSIZIONE / COMBINATION / KOMBINATION / COMPOSITION

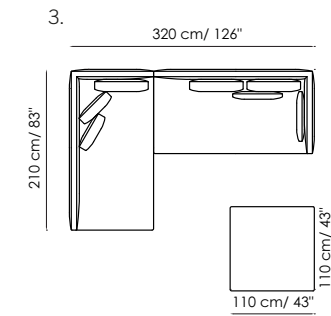
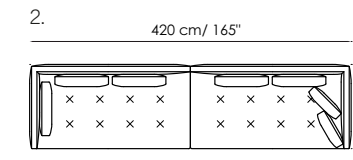
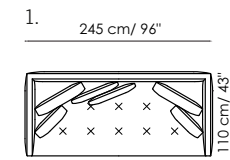

Pag. 127, 128-129:

N°1 FR15 - Divano 245 / Sofa / Sofa / Canapé - **98X**, piedi antracite / anthracite grey feet / Anthrazitgrau FüÙe / pieds gris anthracite.
Seduta con bottoni / seat with buttons / Sitz mit Knöpfe / siége avec boutons.
N°2 CUP5 - Cuscino 70x55 / cushion / Kissen / coussin - **M97**
N°2 CUP6 - Cuscino 50x50 / cushion / Kissen / coussin - **MA79**
N°2 CUP7 - Cuscino 65x40 / cushion / Kissen / coussin - **MA57**

Pag. 130-131, 132, 133:

67K, piedi amaranto / amaranth feet / Amaranth FüÙe / pieds amarante.
Seduta con bottoni / seat with buttons / Sitz mit Knöpfe / siége avec boutons
N°1 FR5D - Terminale 210 dx / End section sofa right / Sofa Endteil Recht / Élément terminal droit
N°1 FR5S - Terminale 210 sx / End section sofa left / Sofa Endteil links / Élément terminal gauche
N° 5 CUP5 - Cuscino 70x55 / cushion / Kissen / coussin
N°2 CUP6 - Cuscino 50x50 / cushion / Kissen / coussin

Pag. 134-135, 136, 137:

M73, piedi antracite / anthracite grey feet / Anthrazitgrau FüÙe / pieds gris anthracite.
Seduta liscia / plain seat / Glatter Sitz / siége lisse
N°2 FR5D - Terminale 210 dx / End section sofa right / Sofa Endteil Recht / Élément terminal droit
N°1 OR15 - Pouf 110x110
N°3 CUP5 - Cuscino 70x55 / cushion / Kissen / coussin
N°2 CUP6 - Cuscino 50x50 / cushion / Kissen / coussin
N°2 CUP7 - Cuscino 65x40 / cushion / Kissen / coussin

GOSSIP



1 RIVESTIMENTO / COVER / BEZUG / REVÊTEMENT

RIVESTIMENTO	UPHOLSTERY	BEZUG	REVÊTEMENT
pelle	leather	Leder	cuir souple
tessuto	fabric	Stoff	tissu

2 SCHIENALE / BACKREST / RÜCKENLEHNE / DOSSIER

ecopelle	eco leather	Ecoleder	éco-cuir
tessuto	fabric	Stoff	tissu
pelle	leather	Leder	cuir souple

3 BRACCIOLO, VASSOIO E TAVOLINO / ARMREST, SHELF, SMALL TABLE / ARMLEHNE, REGAL, KLEINTISCH / ACCOUDOIR, ÉTAGÈRE, PETITE TABLE

ecopelle	eco leather	Ecoleder	éco-cuir
pelle	leather	Leder	cuir souple

4 DIMENSIONI / DIMENSIONS / GRÖSSEN / DIMENSIONS
PROFONDITÀ 85 / DEPTH 85 / TIEFE 85 / PROFONDEUR 85

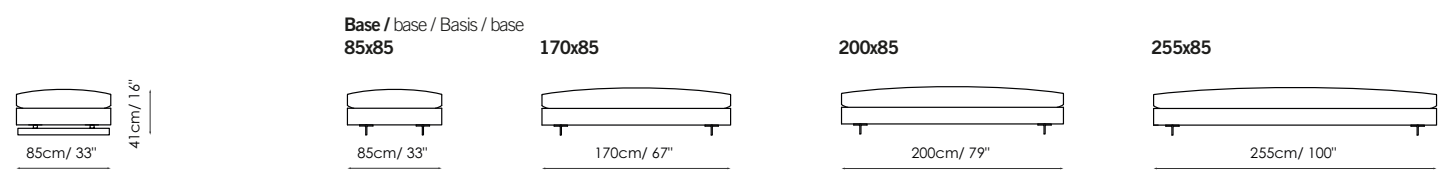

PROFONDITÀ 100 / DEPTH 100 / TIEFE 100 / PROFONDEUR 100

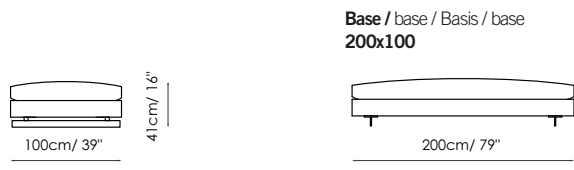

PROFONDITÀ 130 / DEPTH 130 / TIEFE 130 / PROFONDEUR 130

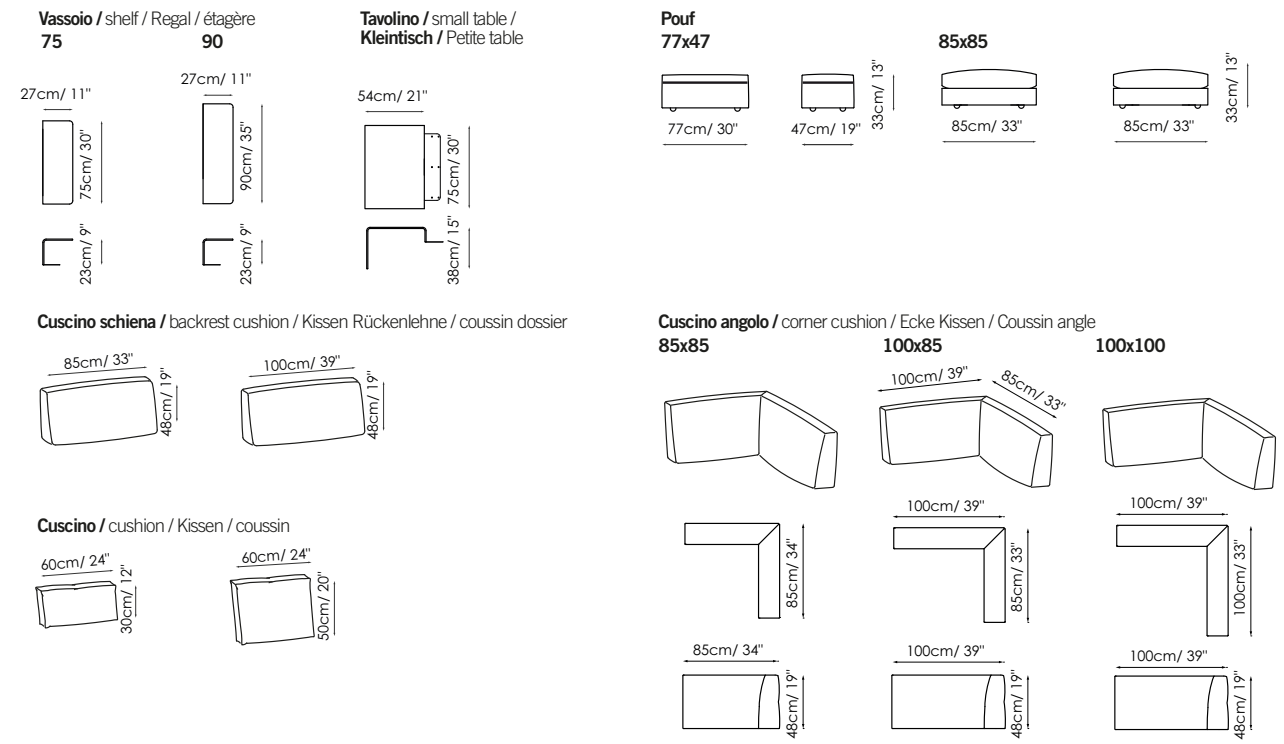
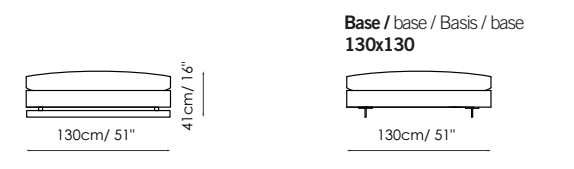

COMPOSIZIONE / COMBINATION / KOMBINATION / COMPOSITION

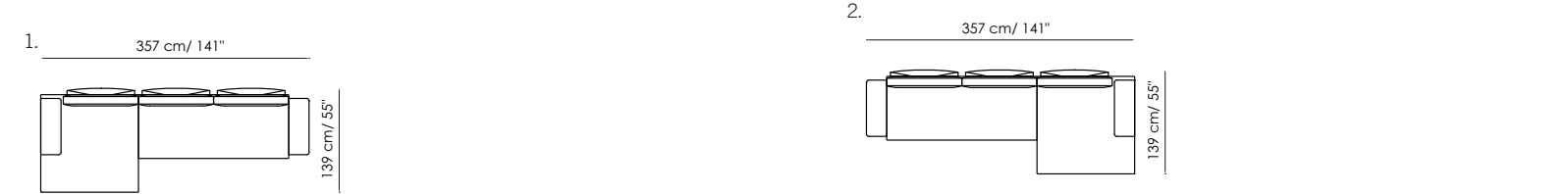

Pag. 73, 74-75, 76, 77:
 N°1 FGS3 - Base 200x85 / base / Basis / base - **MB51**, piedi tortora / dove grey feet / Taubengrau FüÙe / pieds gris tourterelle
 N°1 FGS6 - Base 130x130 / base / Basis / base - **MB51**, piedi tortora / dove grey feet / Taubengrau FüÙe / pieds gris tourterelle
 N°3 BGS6 - Schienale 90 / backrest / Rückenlehne / dossier - **MB59**
 N°3 CGS1 - Cuscino schiena 100x48 / backrest cushion / Kissen Rückenlehne / coussin dossier - **MB51**
 N°1 BGS1 - Bracciolo 75 / armrest / Armlehne / accouoir - **A05**
 N°1 BGS3 - Vassoio 75 / shelf / Regal / étagère - **A05**

Pag. 78-79:
 N°1 FGS3 - Base 200x85 / base / Basis / base - **96D**, piedi tortora / dove grey feet / Taubengrau FüÙe / pieds gris tourterelle
 N°1 FGS6 - Base 130x130 / base / Basis / base - **96D**, piedi tortora / dove grey feet / Taubengrau FüÙe / pieds gris tourterelle
 N°3 BGS6 - Schienale 90 / backrest / Rückenlehne / dossier - **L49**
 N°3 CGS1 - Cuscino schiena 100x48 / backrest cushion / Kissen Rückenlehne / coussin dossier - **96D**
 N°1 BGS1 - Bracciolo 75 / armrest / Armlehne / accouoir - **L49**
 N°1 BGS3 - Vassoio 75 / shelf / Regal / étagère - **L49**

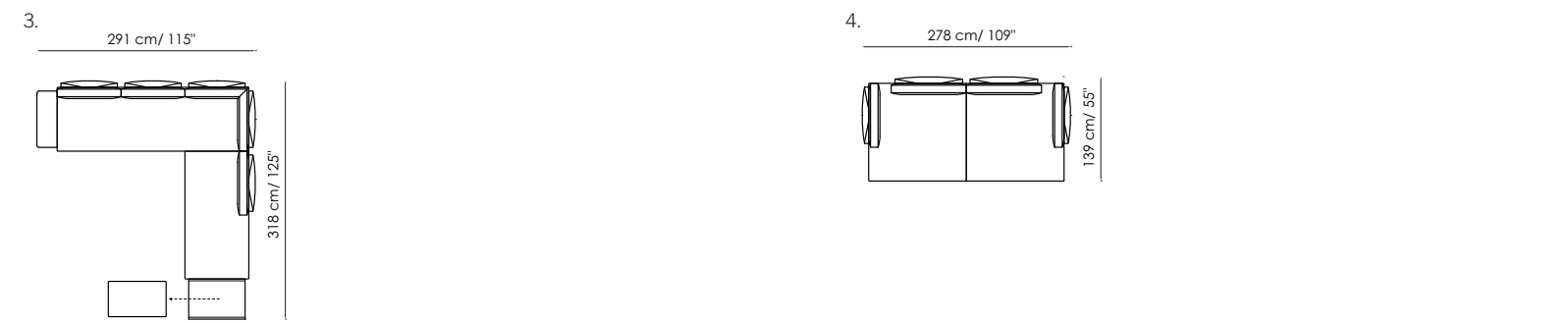

Pag. 80-81:
 N°1 FGS4 - base 255x85 / base / Basis / base - **96B**, piedi antracite / anthracite grey feet / Anthrazitgrau FüÙe / pieds gris anthracite
 N°1 FGS2 - base 170x85 / base / Basis / base - **96B**, piedi antracite / anthracite grey feet / Anthrazitgrau FüÙe / pieds gris anthracite
 N°3 CGS2 - cuscino 85x48 / backrest cushion / Kissen Rückenlehne / coussin dossier - **96B**
 N°1 CGS5 - cuscino angolare 85x85 / corner cushion / Ecke Kissen / Angle coussin - **96B**
 N°1 OGS1 - Pouf 77x47 su ruote / on wheels / mit Rollen / avec rouettes - **96B**
 N°5 BGS5 - schienale 75 backrest / Rückenlehne / dossier - **201**
 N°1 BGS1 - Bracciolo 75 / armrest / Armlehne / accouoir - **201**
 N°1 FGS7 - Tavolino / small table / Kleintisch / Petite table - **201**

Pag. 82-83:
 N°2 FGS6 - base 130x130 / base / Basis / base - **9B19**, piedi antracite / anthracite grey feet / Anthrazitgrau FüÙe / pieds gris anthracite
 N°2 BGS6 - schienale 90 / backrest / Rückenlehne / dossier - **204**
 N°2 CGS1 - Cuscino schiena 100x48 / backrest cushion / Kissen Rückenlehne / coussin dossier - **9B19**
 N°2 BGS5 - schienale 75 backrest / Rückenlehne / dossier - **204**
 N°2 CGS2 - Cuscino schiena 85x48 / backrest cushion / Kissen Rückenlehne / coussin dossier - **9B19**

HIRO



1 RIVESTIMENTO / COVER / BEZUG / REVÊTEMENT

RIVESTIMENTO	UPHOLSTERY	BEZUG	REVÊTEMENT
pelle tessuto	leather fabric	Leder Stoff	cuir souple tissu

2 SUPPORTO SCHIENA / BACK SUPPORT / RÜCHENSTÜTZE / SUPPORT DOSSIER

standard nello stesso rivestimento dell'elemento.
Con supplemento è possibile ordinare il supporto in un diverso rivestimento.

in the same cover of the sofa.
With extra charge it is possible to order the back support in a different cover colour.

Unterstützung ist immer in der gleiche Stoff- oder Lederkategorie des Sofas vorgesehen.
Mit Aufpreis kann die Rückenstütze in eine andere Kategorie bestellt werden.

dans la même housse du canapé.
Avec une majoration de prix on peut commander ce support avec un autre housse.

3 PIEDI / FEET / FÜÙE / PIEDS

LEGNO COLOR	PAINTED WOOD	HOLZ	BOIS TEINTÉ
1. grigio antracite	1. anthracite grey	1. Anthrazitgrau	1. gris anthracite

DIMENSIONI / DIMENSIONS / GRÖÙSEN / DIMENSIONS

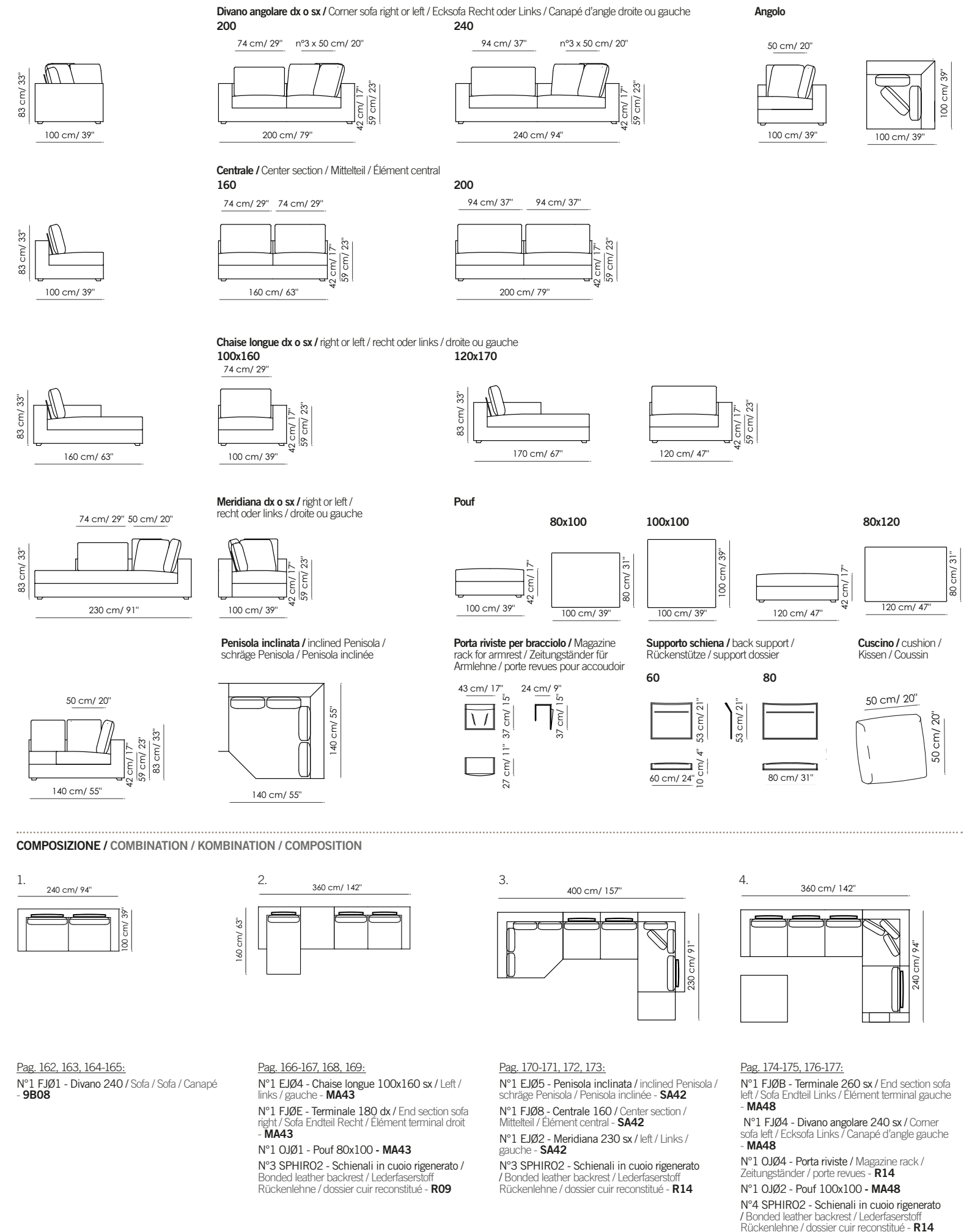
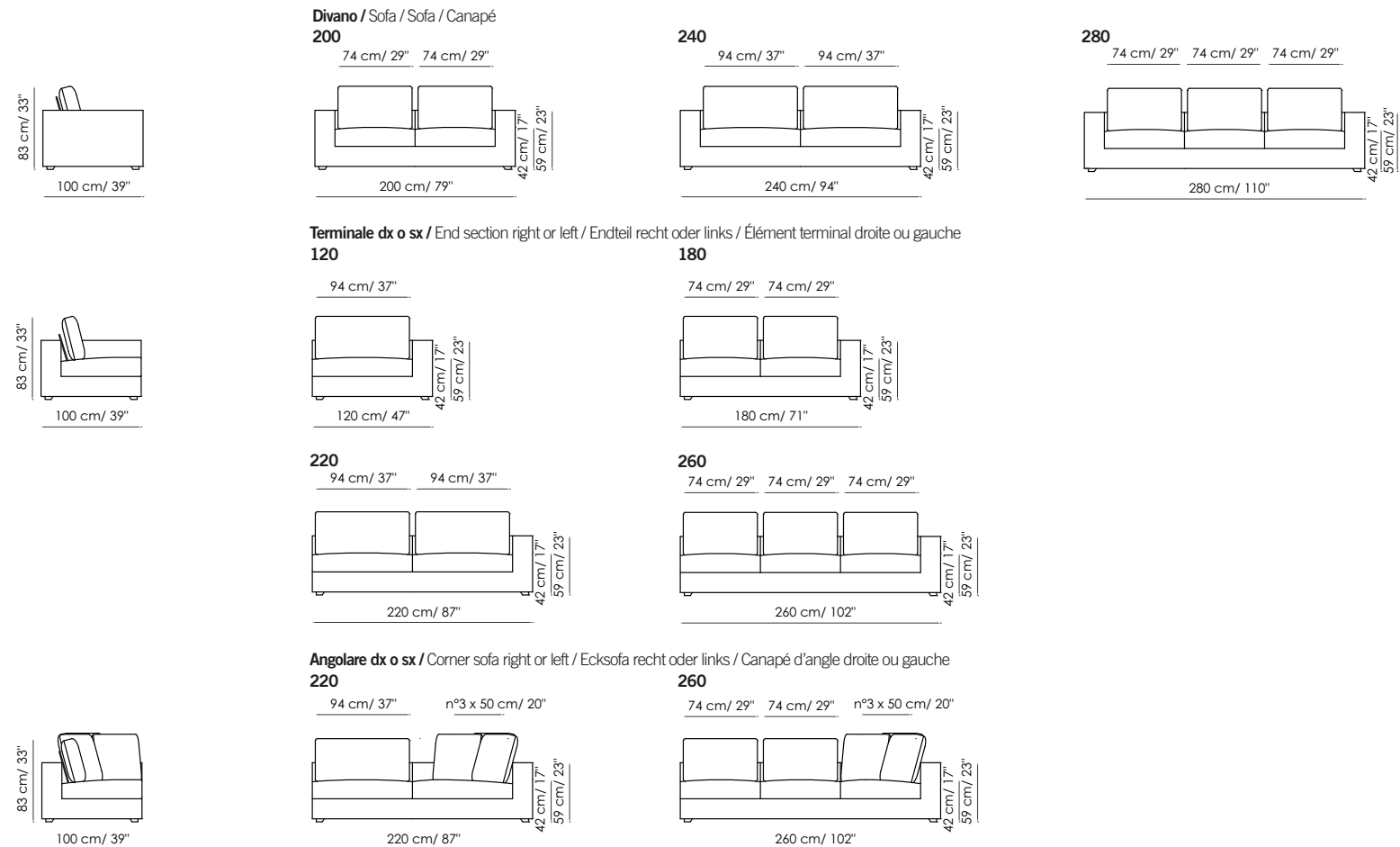

Pag. 162, 163, 164-165:
N°1 FJØ1 - Divano 240 / Sofa / Sofa / Canapé - **9B08**

Pag. 166-167, 168, 169:
N°1 EJØ4 - Chaise longue 100x160 sx / Left / links / gauche - **MA43**
N°1 FJØE - Terminale 180 dx / End section sofa right / Sofa Endteil Recht / Élément terminal droit - **MA43**
N°1 OJØ1 - Pouf 80x100 - **MA43**
N°3 SPHIRO2 - Schienali in cuoio rigenerato / Bonded leather backrest / Lederfaserstoff Rückenlehne / dossier cuir reconstritué - **R09**

Pag. 170-171, 172, 173:
N°1 EJØ5 - Penisola inclinata / inclined Penisola / schräge Penisola / Penisola inclinée - **SA42**
N°1 FJØ8 - Centrale 160 / Center section / Mittelteil / Élément central - **SA42**
N°1 EJØ2 - Meridiana 230 sx / left / Links / gauche - **SA42**
N°3 SPHIRO2 - Schienali in cuoio rigenerato / Bonded leather backrest / Lederfaserstoff Rückenlehne / dossier cuir reconstritué - **R14**

Pag. 174-175, 176-177:
N°1 FJØB - Terminale 260 sx / End section sofa left / Sofa Endteil Links / Élément terminal gauche - **MA48**
N°1 FJØ4 - Divano angolare 240 sx / Corner sofa left / Eckssofa Links / Canapé d'angle gauche - **MA48**
N°1 OJØ4 - Porta riviste / Magazine rack / Zeitungständer / porte revues - **R14**
N°1 OJØ2 - Pouf 100x100 - **MA48**
N°4 SPHIRO2 - Schienali in cuoio rigenerato / Bonded leather backrest / Lederfaserstoff Rückenlehne / dossier cuir reconstritué - **R14**



1
RIVESTIMENTO / COVER / BEZUG / REVÊTEMENT

RIVESTIMENTO
pelle
tessuto

UPHOLSTERY
leather
fabric

BEZUG
Leder
Stoff

REVÊTEMENT
cuir souple
tissu

2
PIEDI / FEET / FÜÙE / PIEDS
(disponibile con piedi o base a slitta) / (available with feet or sliding base) /
(mit FüÙe oder mit Kufenbasis erhaltlich) / (disponible avec pieds ou coulisse)

METALLO VERNICIATO OPACO

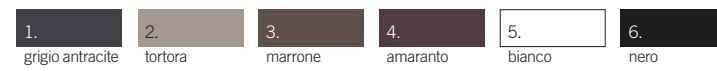

MAT PAINTED METAL

1. anthracite grey
2. dove grey
3. brown
4. amaranth
5. white
6. black

LACKIERT MATT METAL

1. Anthrazitgrau
2. Taubengrau
3. Braun
4. Amaranth
5. Weiss
6. Schwarz

METAL VERNI OPAQUE

1. gris anthracite
2. gris tourterelle
3. marron
4. amarante
5. blanc
6. noir

DIMENSIONI / DIMENSIONS / GRÖÙSEN / DIMENSIONS
SCHIENALE BASSO / LOW BACKREST / NIEDRIGE RÜCKENLEHNE / DOSSIER BAS (H 73 CM)

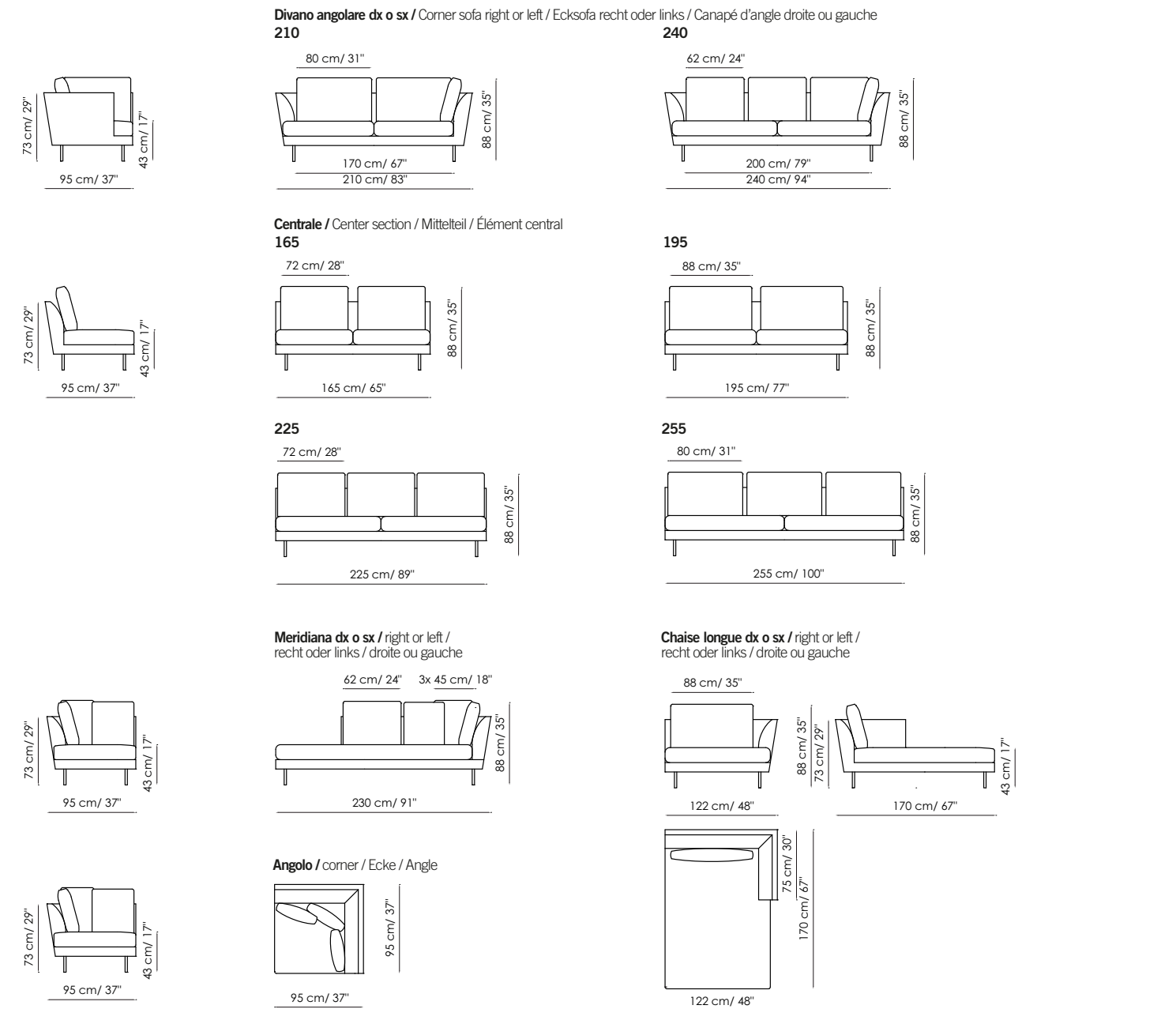
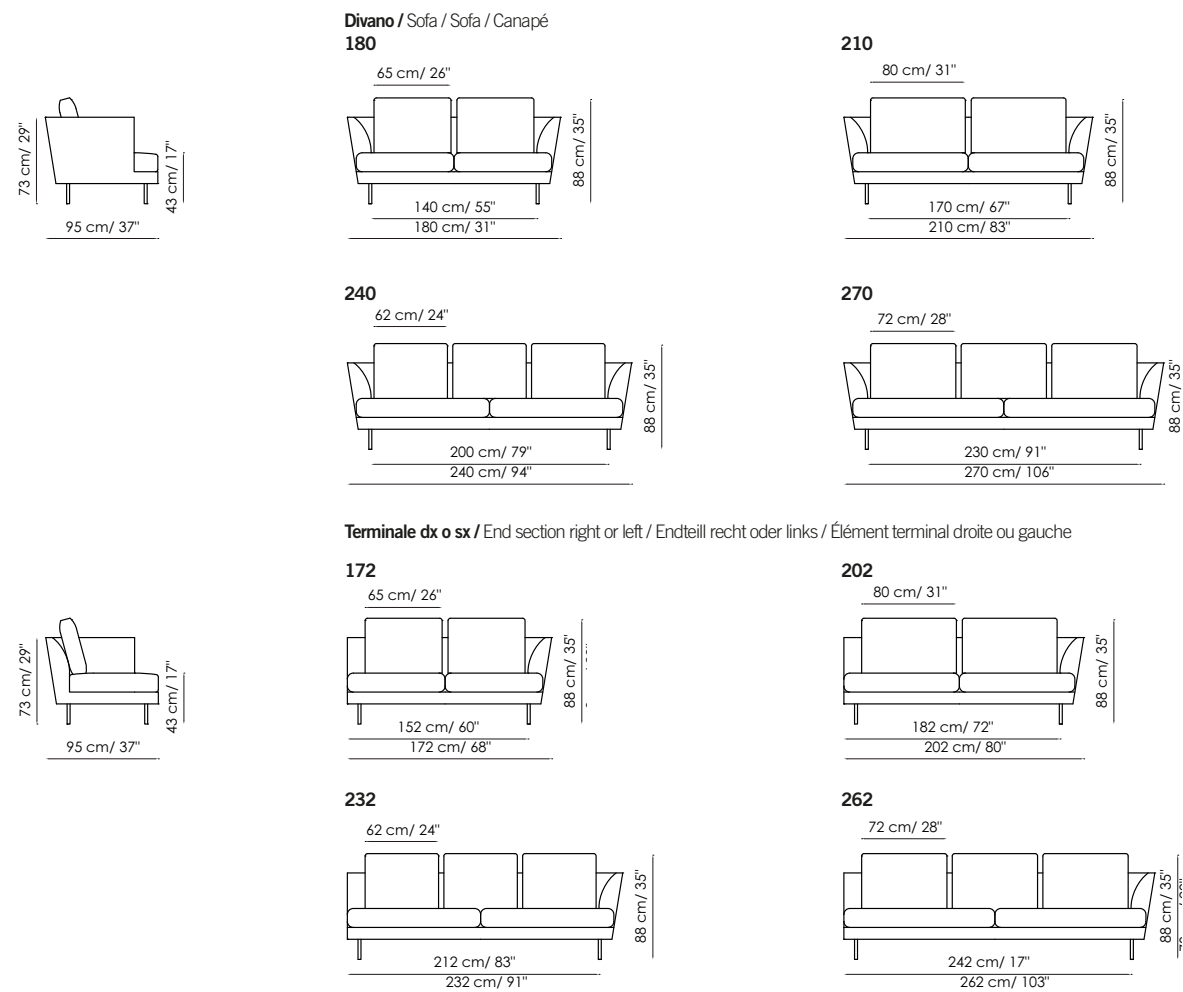

LARS

COMPOSIZIONE / COMBINATION / KOMBINATION / COMPOSITION

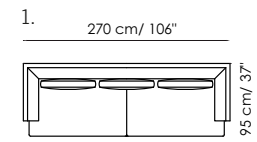

Pag. 41-42-43:
 N°1 F7B5 - Divano 270 schienale basso / Sofa low backrest / Sofa niedrige Rückenlehne / Canapé dossier bas
 - **MB74**, piedi tortora / dove grey feet / Taubengrau Füße / pieds gris tourterelle

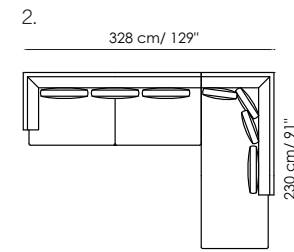

N°1 F73S - Terminale 232 schienale basso sx / End section sofa low backrest left / Sofa Endteil niedrige Rückenlehne Links / Élément terminal dossier bas gauche
 N°1 E72S - Meridiana schienale basso sx / low backrest left / niedrige Rückenlehne Links / dossier bas gauche

Pag. 44-45
M72, piedi tortora / dove grey feet / Taubengrau Füße / pieds gris tourterelle
Pag. 46-47
MA20, piedi tortora / dove grey feet / Taubengrau Füße / pieds gris tourterelle

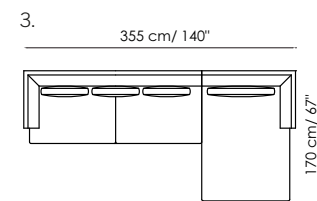

Pag. 48-49:
SA73, piedi tortora / dove grey feet / Taubengrau Füße / pieds gris tourterelle
 N°1 F73S - Terminale 232 schienale basso sx / End section sofa low backrest left / Sofa Endteil niedrige Rückenlehne Links / Élément terminal dossier bas gauche
 N°1 E73D - Chaise Longue 122x170 dx / low backrest right / niedrige Rückenlehne Recht / dossier bas droit

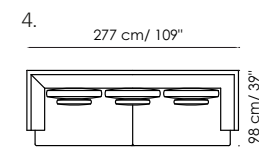

N°1 F7A5 - Divano 277 schienale alto / Sofa high backrest / Sofa höhere Rückenlehne / Canapé dossier haut
Pag. 52-53:
EA66, piedi antracite / anthracite grey feet / Anthrazitgrau Füße / pieds gris anthracite
Pag. 54-55, 56-57:
SA44, piedi tortora / dove grey feet / Taubengrau Füße / pieds gris tourterelle

LARS PLUS



1 RIVESTIMENTO / COVER / BEZUG / REVÊTEMENT

RIVESTIMENTO
pelle
tessuto

UPHOLSTERY
leather
fabric

BEZUG
Leder
Stoff

REVÊTEMENT
cuir souple
tissu

2 PIEDI / FEET / FÜÙE / PIEDS
(disponibile con piedi o base a slitta) / (available with feet or sliding base) /
(mit FüÙe oder mit Kufenbasis erhältlich) / (disponible avec pieds ou coulisse)

METALLO VERNICIATO OPACO



MAT PAINTED METAL

1. anthracite grey
2. dove grey
3. brown
4. amaranth
5. white
6. black

LACKIERT MATT METAL

1. Anthrazitgrau
2. Taubengrau
3. Braun
4. Amaranth
5. Weiss
6. Schwarz

METAL VERNI OPAQUE

1. gris anthracite
2. gris tourterelle
3. marron
4. amaranthe
5. blanc
6. noir

DIMENSIONI / DIMENSIONS / GRÖÙEN / DIMENSIONS
SCHIENALE BASSO / LOW BACKREST / NIEDRIGE RÜCKENLEHNE / DOSSIER BAS (h 73 cm)

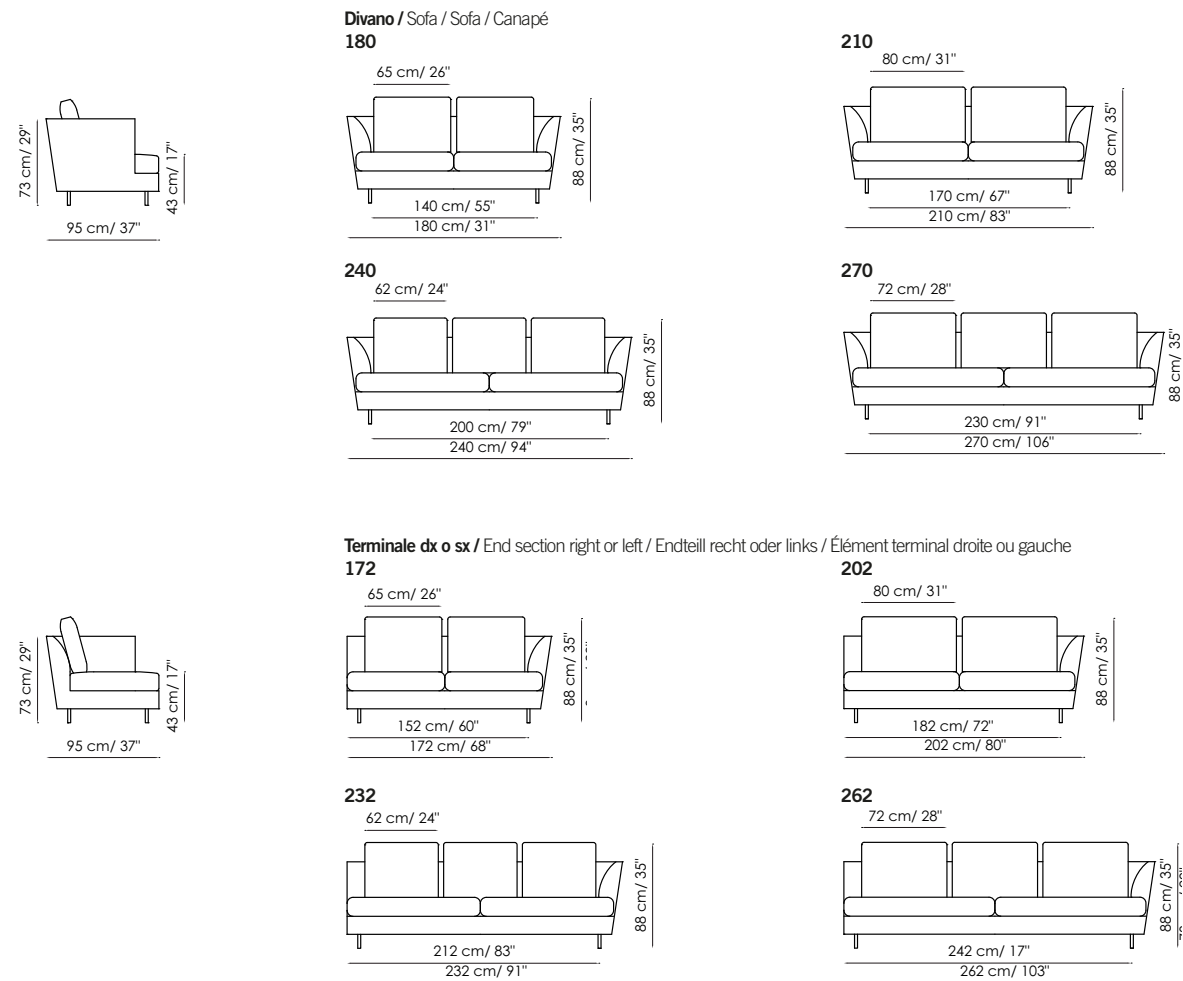

LARS PLUS

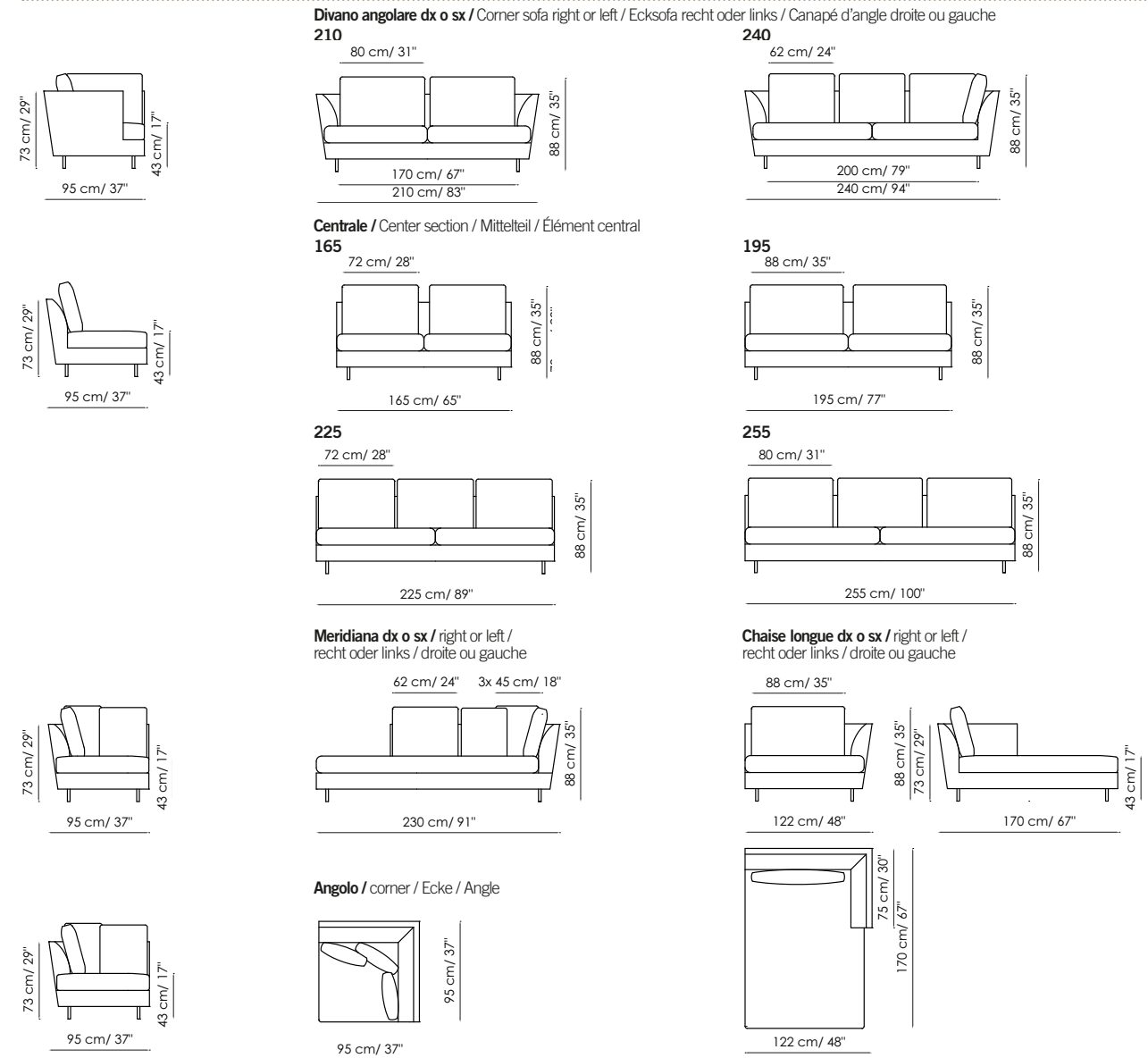

DIMENSIONI / DIMENSIONS / GRÖÙEN / DIMENSIONS
SCHIENALE ALTO / HIGH BACKREST / HÖHERE RÜCKENLEHNE / DOSSIER HAUT (H 93 CM)

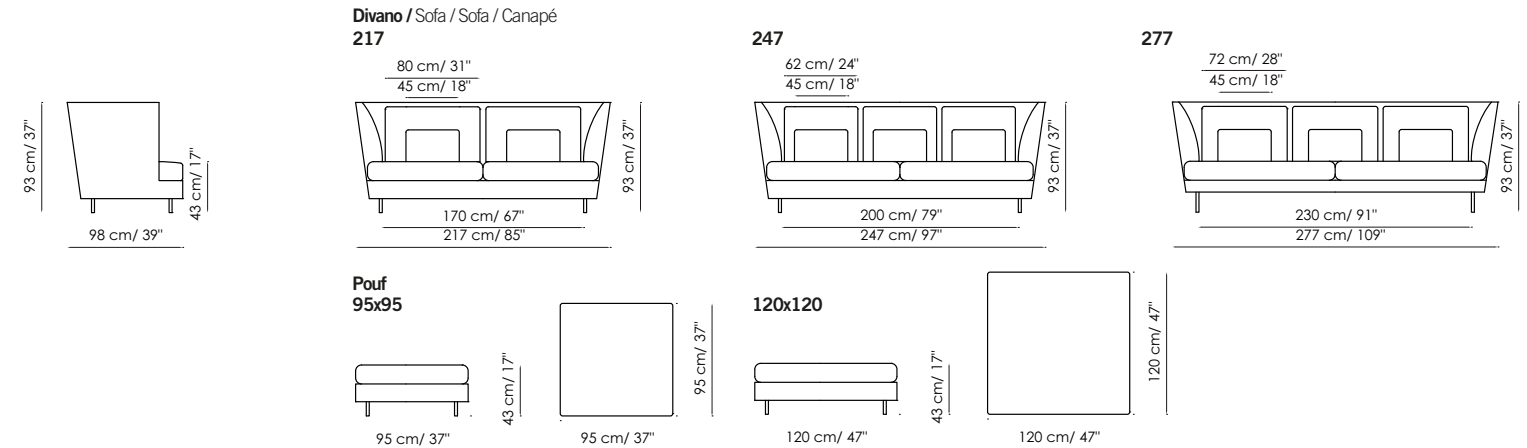

COMPOSIZIONE / COMBINATION / KOMBINATION / COMPOSITION

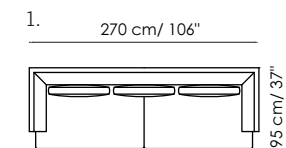

Pag. 50-51:
N°1 F7B8 - Divano 270 schienale basso / Sofa low backrest / Sofa
niedrige Rückenlehne / Canapé dossier bas - M74, piedi antracite /
anthracite grey feet / Anthrazitgrau FüÙe / pieds gris anthracite

PARAISO



1 RIVESTIMENTO / COVER / BEZUG / REVÊTEMENT

RIVESTIMENTO	UPHOLSTERY	BEZUG	REVÊTEMENT
pelle* tessuto	leather* fabric	Leder* Stoff	cuir souple* tissu
* non disponibile per versione con balza	* not available for the version with frill	* nicht verfügbar mit Rüschen	* pas disponible dans la version avec volant

2 PIEDI / FEET / FÜÙE / PIEDS

METALLO VERNICIATO OPACO

1. grigio antracite	2. tortora	3. marrone	4. amaranto	5. bianco	6. nero
---------------------	------------	------------	-------------	-----------	---------

LEGNO

7. color moka	8. naturale
---------------	-------------

RIVESTITI IN PELLE CAPRI

MAT PAINTED METAL	LACKIERT MATT METAL	METAL VERNI OPAQUE
1. anthracite grey 2. dove grey 3. brown 4. amaranth 5. white 6. black	1. Anthrazitgrau 2. Taubengrau 3. Braun 4. Amaranth 5. Weiss 6. Schwarz	1. gris anthracite 2. gris tourterelle 3. marron 4. amarante 5. blanc 6. noir
WOOD	HOLZ	BOIS
7. dark brown 8. natural	7. Dunkelbraunfarbig 8. Naturfarbig	7. marron foncé 8. naturel
CAPRI LEATHER COVERED	AUS LEDER CAPRI BEZOGEN	REVÊTUS EN CUIR SOUPLE CAPRI

DIMENSIONI / DIMENSIONS / GRÖÙEN / DIMENSIONS

Divano / Sofa / Sofa / Canapé

175 **205**

245 - 2 sedute / 2 seats / 2 Sitz / 2 assises **245 - 3 sedute / 3 seats / 3 Sitz / 3 assises** **275**

Terminale dx o sx / End section right or left / Endteil recht oder links / Élément terminal droite ou gauche

160 **190** **245 - 2 sedute / 2 seats / 2 Sitz / 2 assises** **245 - 3 sedute / 3 seats / 3 Sitz / 3 assises**

Angolo / corner / Ecke / Angle
210

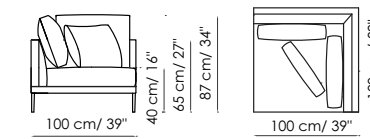

Meridiana dx o sx / right or left / recht oder links / droite ou gauche

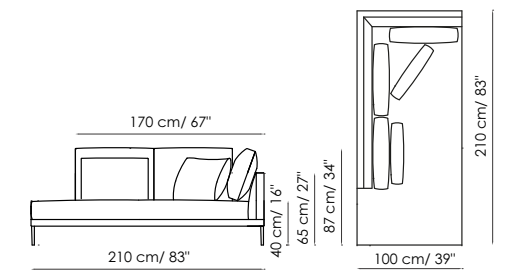

Chaise longue dx o sx / right or left / recht oder links / droite ou gauche

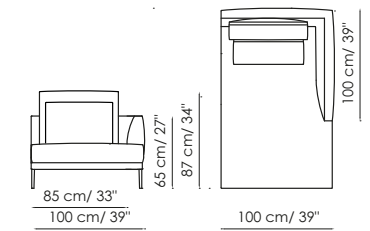

Pouf
75x50

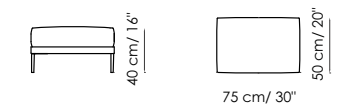

85x50

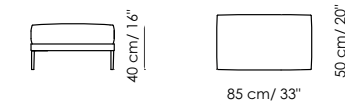

Cuscino / cushion / Kissen / coussin

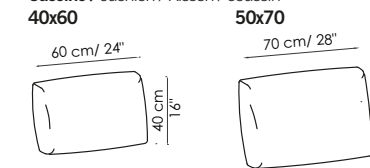

100x100

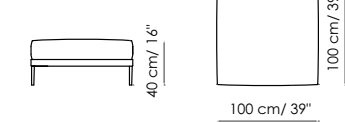

Cuscino poggianti / lumbar cushion / Lendenkissen / coussin lombaire

40x25



COMPOSIZIONE / COMBINATION / KOMBINATION / COMPOSITION

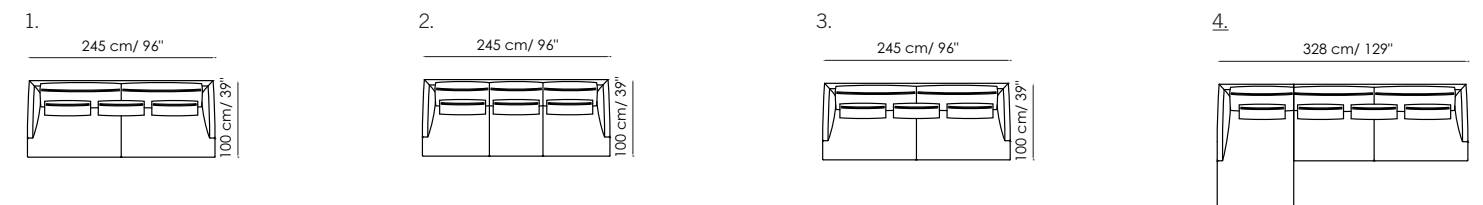

Pag. 107, 108-109:

N°1 FPZ3 - Divano 245 2 sedute con balza / Sofa 245 2 seats with frill / Sofa 245 2 Sitz mit Rüschen / Canapé 245 2 assises avec volant - **96B**

Pag. 110, 111, 112-113

N°1 FR14 - Divano 245 3 sedute / Sofa 245 3 seats / sofa 245 3 Sitz / Canapé 245 3 assises - **96A**, piedi bianchi / white feet / Weiss FüÙe / pieds blancs

Pag. 114, 115:

N°1 FR13 - Divano 245 2 sedute / Sofa 245 2 seats / sofa 245 2 Sitz / Canapé 245 2 assises - **8D54**, piedi antracite / anthracite grey feet / Anthrazitgrau FüÙe / pieds gris anthracite

Pag. 116-117

8D55, piedi antracite / anthracite grey feet / Anthrazitgrau FüÙe / pieds gris anthracite
N°1 ER1S - chaise longue 100x160 sx / Left / links / gauche
N°1 FR3D - Terminale 225 2 sedute dx / end section sofa 225 2 seats right / Sofa Endteil 225 2 Sitz Recht / Élément terminal 225 2 assises droit

PARAISO PLUS



1
RIVESTIMENTO / COVER / BEZUG / REVÊTEMENT

RIVESTIMENTO
pelle*
tessuto

* non disponibile per versione con balza

UPHOLSTERY
leather*
fabric

* not available for the version with frill

BEZUG
Leder*
Stoff

* nicht verfügbar mit Rüschen

REVÊTEMENT
cuir souple*
tissu

* pas disponible dans la version avec volant

2
PIEDI / FEET / FÜÙE / PIEDS

METALLO VERNICIATO OPACO



LEGNO

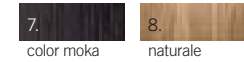

RIVESTITI IN PELLE

MAT PAINTED METAL

1. anthracite grey
2. dove grey
3. brown
4. amaranth
5. white
6. black

WOOD

7. dark brown
8. natural

LEATHER COVERED

LACKIERT MATT METAL

1. Anthrazitgrau
2. Taubengrau
3. Braun
4. Amaranth
5. Weiss
6. Schwarz

HOLZ

7. Dunkelbraunfarbig
8. Naturfarbig

AUS LEDER BEZOGEN

METAL VERNI OPAQUE

1. gris anthracite
2. gris tourterelle
3. marron
4. amarante
5. blanc
6. noir

BOIS

7. marron foncé
8. naturel

REVÊTUS EN CUIR SOUPLE

DIMENSIONI / DIMENSIONS / GRÖÙSEN / DIMENSIONS

Divano / Sofa / Sofa / Canapé
175

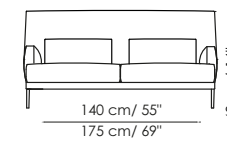

205

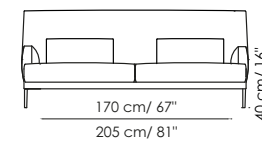

Terminale dx o sx / End section right or left /
Endteil recht oder links / Élément terminal droite ou gauche

190

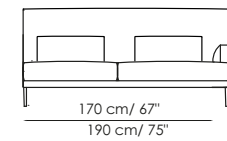

Pouf
85x50

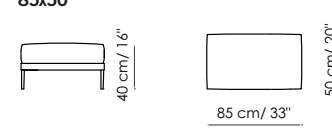

85x85

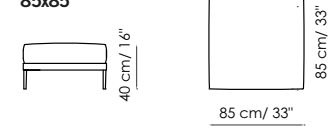

Chaise longue dx o sx / right or left /
recht oder links / droite ou gauche

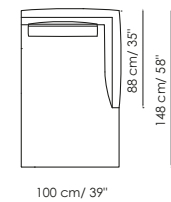

Cuscino poggiategni / lumbar cushion /
Lendenkissen / coussin lombaire
40x25

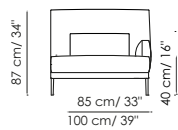
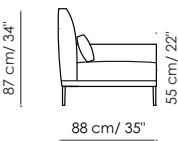
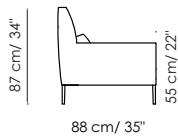
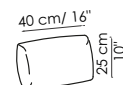

COMPOSIZIONE / COMBINATION / KOMBINATION / COMPOSITION

1.

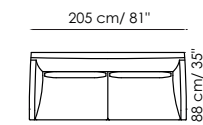

2.

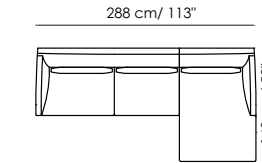

Pag. 120-121:

N°1 FPY2 - Divano 205 con balza / sofa with frill / Sofa mit Rüschen / canapé avec volant - **96D**

Pag. 122-123:

MA47, piedi antracite / anthracite grey feet / Anthrazitgrau FüÙe / pieds gris anthracite

N°1 FRIB - Terminale 190 sx / End section sofa left / Sofa Endteil links / Élément terminal gauche

N°1 FRIC - Chaise longue 100x148 dx / right / Recht / droit

PEANUT AIR



1 RIVESTIMENTO / COVER / BEZUG / REVÊTEMENT

RIVESTIMENTO
pelle
tessuto

UPHOLSTERY
leather
fabric

BEZUG
Leder
Stoff

REVÊTEMENT
cuir souple
tissu

2 PIEDI / FEET / FÜÙE / PIEDS

METALLO VERNICIATO OPACO



MAT PAINTED METAL

1. anthracite grey
2. dove grey
3. brown
4. amaranth
5. white
6. black

LACKIERT MATT METAL

1. Anthrazitgrau
2. Taubengrau
3. Braun
4. Amaranth
5. Weiss
6. Schwarz

METAL VERNI OPAQUE

1. gris anthracite
2. gris tourterelle
3. marron
4. amarante
5. blanc
6. noir

DIMENSIONI / DIMENSIONS / GRÖÙEN / DIMENSIONS

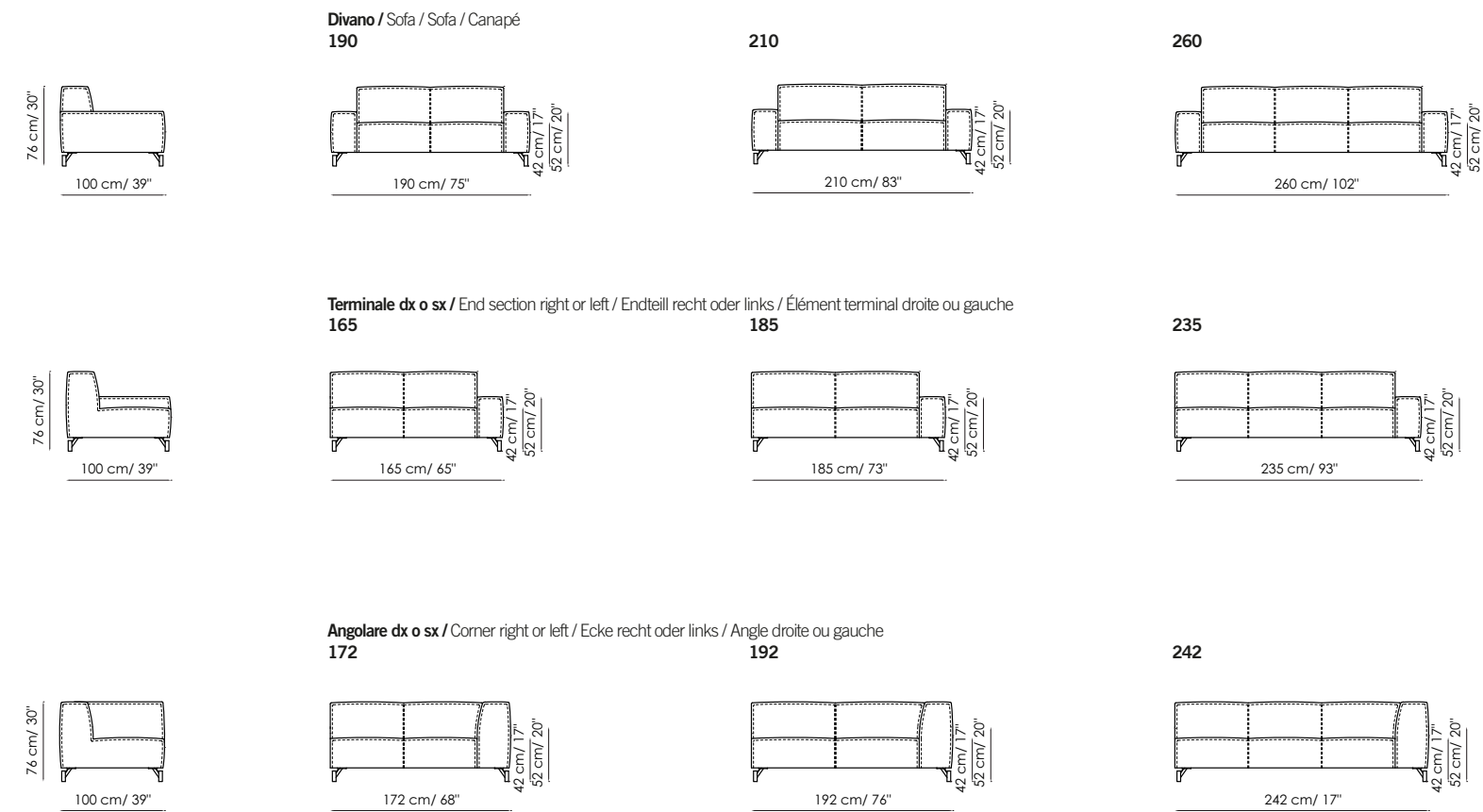

Chaise longue dx o sx / right or left / recht oder links / droite ou gauche
105x150

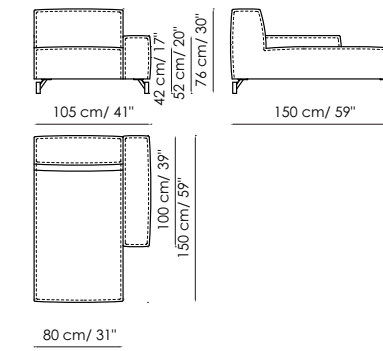

125x170

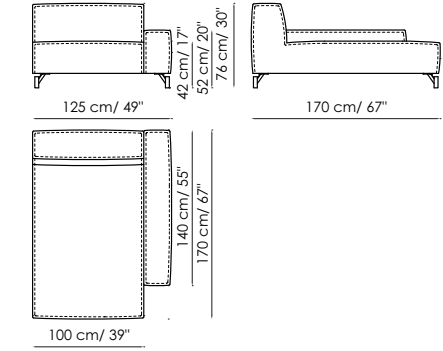

Pouf
100x75

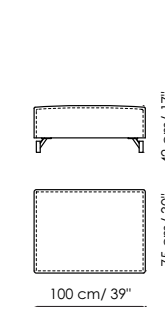

100x100

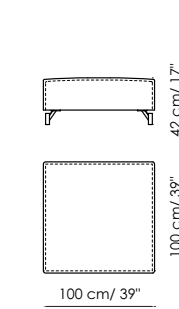

100x150

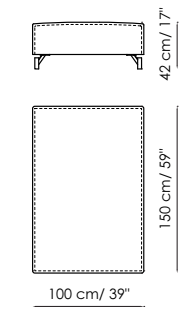

Cuscino / cushion / Kissen / coussin
50x50

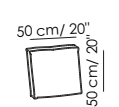

COMPOSIZIONE / COMBINATION / KOMBINATION / COMPOSITION



Pag. 66, 67, 68-69:
N°1 FN21 - Divano 260 / Sofa / Sofa / Canapé
- SA50, piedi tortora / dove grey feet / Taubengrau FüÙe / pieds gris tourterelle

Pag. 70-71:
98L, piedi tortora / dove grey feet / Taubengrau FüÙe / pieds gris tourterelle
N°1 FN16 - Terminale 235 sx / End section sofa left / Sofa Endteil Links / Élément terminal gauche
N°1 ENØ3 - Chaise Longue 125x170 dx / right / Recht / droit

PEANUT B



1 RIVESTIMENTO / COVER / BEZUG / REVÊTEMENT

RIVESTIMENTO
pelle
tessuto

UPHOLSTERY
leather
fabric

BEZUG
Leder
Stoff

REVÊTEMENT
cuir souple
tissu

2 PIEDI / FEET / FÜÙE / PIEDS

LEGNO COLOR
1. grigio antracite

PAINTED WOOD
1. antracite grey

HOLZ
1. Anthrazitgrau

BOIS TEINTÉ
1. gris anthracite

DIMENSIONI / DIMENSIONS / GRÖÙEN / DIMENSIONS

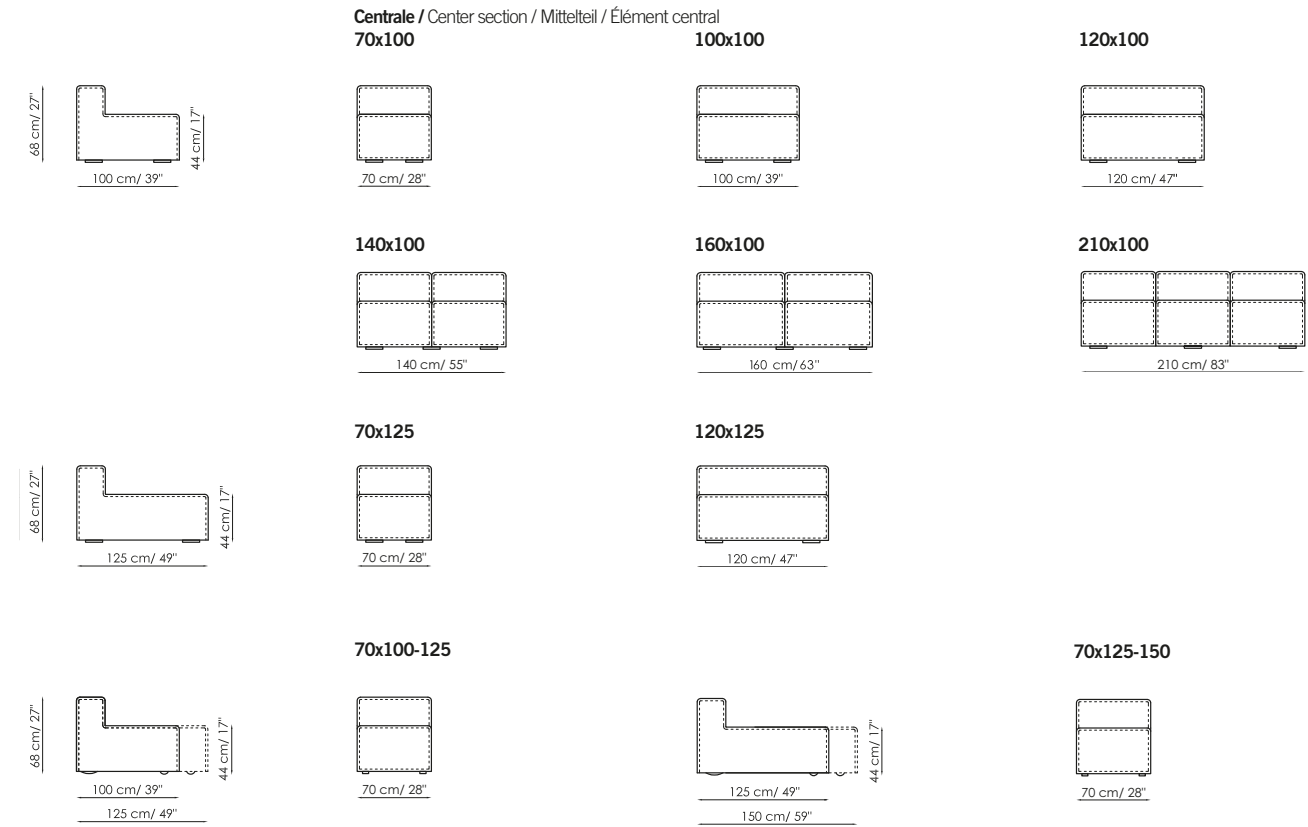
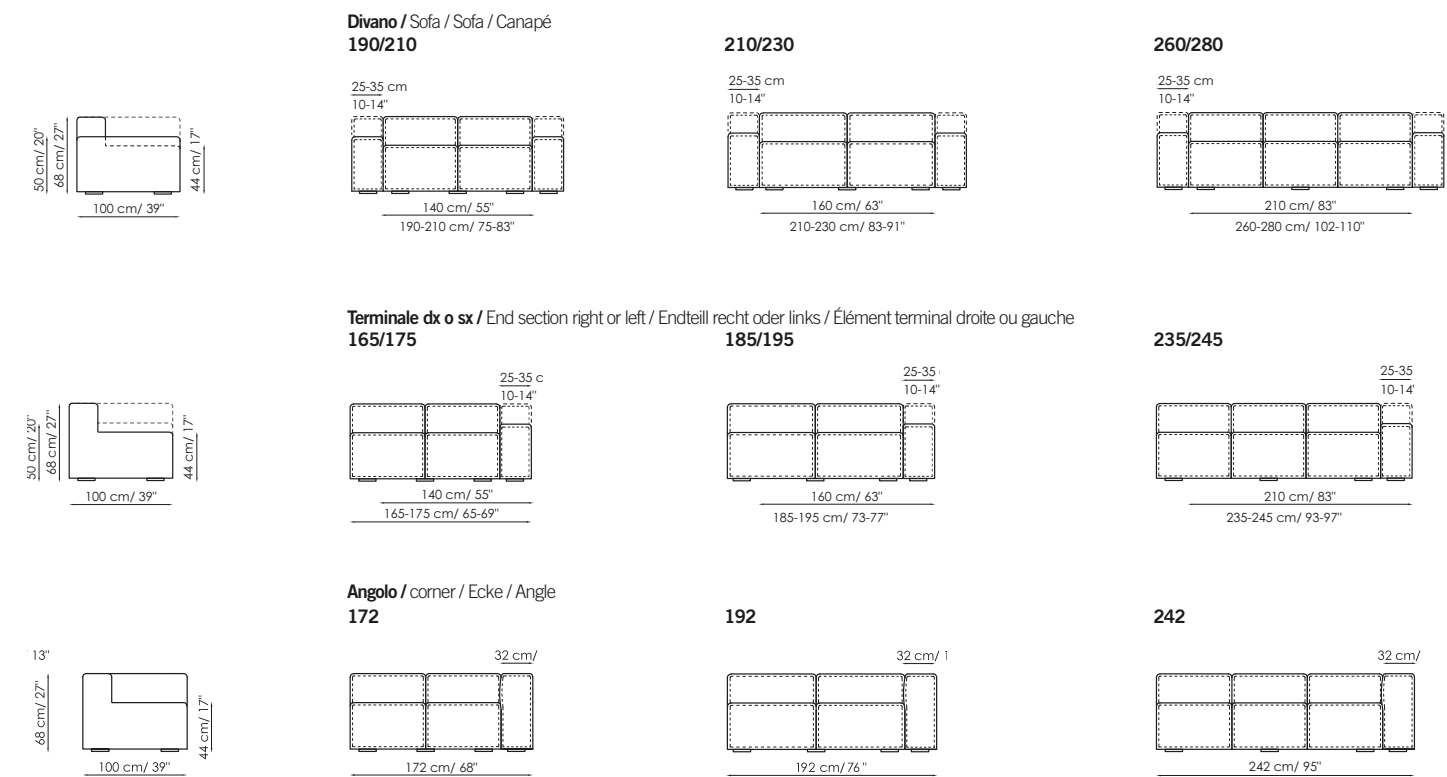

Chaise longue dx o sx / right or left / recht oder links / droite ou gauche

105/115x150

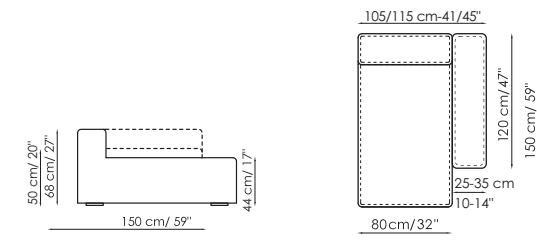

Schienale-Angolare / Backrest-Corner / Rückenlehne-Ecke / Dossier-Angle

100 125

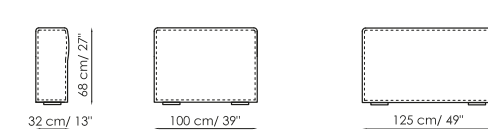

125/135x170

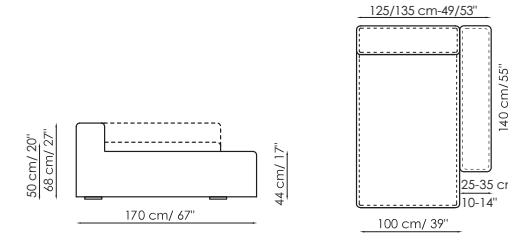

150x170

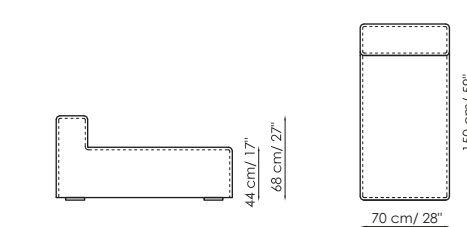

PEANUT B

Penisola
100x75

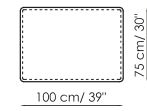
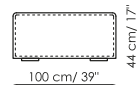

100x100

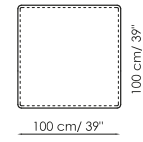

100x150

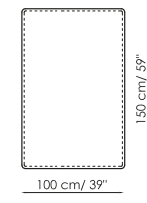

Penisola con schienale / with backrest / mit Rückenlehne / avec dossier

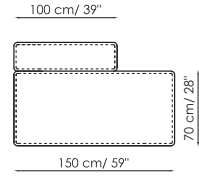
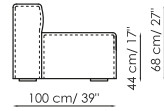

Sinistra / left / Links / gauche

Bracciolo Basso / Armrest / Armlehne / Accoudoir

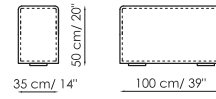
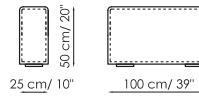

Bracciolo Alto / Armrest / Armlehne / Accoudoir

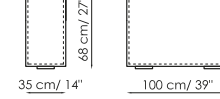
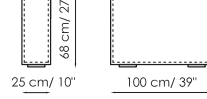

Pouf
100x75

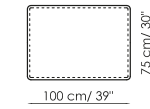
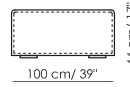

100x100

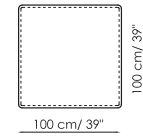
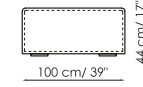

Cuscino / cushion / Kissen / coussin
50x50

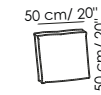

93x75

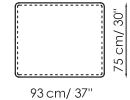
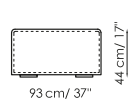

100x150

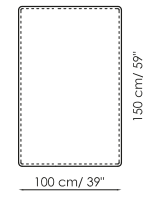
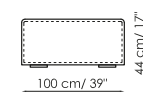

COMPOSIZIONE / COMBINATION / KOMBINATION / COMPOSITION

1.

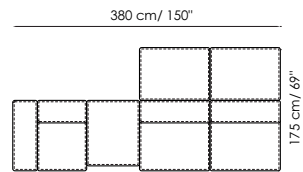

2.

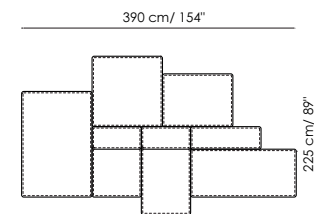

3.

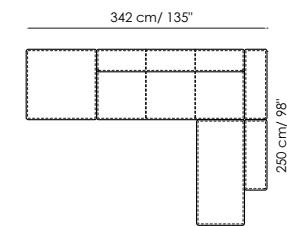

Pag. 59, 60-61:

9B22

N°1 BPB2 - Bracciolo basso h 50x35 / Armrest / Armlehne / Accoudoir

N°1 FPN1 - Centrale 70 prof. 100 / Center section 70 depth 100 / Mittelteil 70 Tiefe 100 / Élément central 70 prof. 100

N°1 OPN4 - pouf 93x75

N°2 FPN2 - Centrale 100 prof. 100 / Center section 100 depth 100 / Mittelteil 100 Tiefe 100 / Élément central 100 prof. 100

N°2 OPNA - penisola 100x75

Pag. 62, 63:

N°1 OPNC - penisola 100x150 - MA22

N°1 OPNB - penisola 100x100 - M88

N°1 OPNA - penisola 100x75 - MA22

N°1 FPN1 - Centrale 70 prof. 100 / Center section 70 depth 100 / Mittelteil 70 Tiefe 100 / Élément central 70 prof. 100 - M88

N°1 FPN3 - Centrale 70 prof. 125 / Center section 70 depth 125 / Mittelteil 70 Tiefe 125 / Élément central 70 prof. 125 - MA22

N°1 FP5S - Penisola con schienale 100x150 sx / Penisola with backrest 100x150 left / Penisola mit Rückenlehne 100x150 Links / Penisola avec dossier 100x150 gauche - M88

Pag. 64, 65:

M69

N°1 OPNB - penisola 100x100

N°1 FPN8 - Centrale 210 prof. 100 / Center section 210 depth 100 / Mittelteil 210 Tiefe 100 / Élément central 210 prof. 100

N°1 BPA3 - Schienale / Angolare prof. 100 / Backrest / Corner depth 100 / Rückenlehne / Ecke Tiefe 100 / Dossier Angle prof. 100

N°1 FP5S - Penisola con schienale 100x150 sx / Penisola with backrest 100x150 left / Penisola mit Rückenlehne 100x150 Links / Penisola avec dossier 100x150 gauche

SKID



1 RIVESTIMENTO / COVER / BEZUG / REVÊTEMENT

RIVESTIMENTO
pelle
tessuto

UPHOLSTERY
leather
fabric

BEZUG
Leder
Stoff

REVÊTEMENT
cuir souple
tissu

2 PIEDI / FEET / FÜÙE / PIEDS
(disponibile con piedi o base a slitta) / (available with feet or sliding base) /
(mit FüÙe oder mit Kufenbasis erhaltlich) / (disponible avec pieds ou coulisse)

METALLO VERNICIATO OPACO



METALLO FINITURA



MAT PAINTED METAL

1. anthracite grey
2. dove grey
3. brown
4. amaranth
5. white
6. black

METAL FINISH

7. chrome
8. black nickel
9. copper bronze

LACKIERT MATT METAL

1. Anthrazitgrau
2. Taubengrau
3. Braun
4. Amaranth
5. Weiss
6. Schwarz

METALL AUSFÜHRUNG

7. Verchromt
8. Schwarz vernickelt
9. Kupferbronze

METAL VERNI OPAQUE

1. gris anthracite
2. gris tourterelle
3. marron
4. amarante
5. blanc
6. noir

FINITION MÉTAL

7. chromé
8. noir nickel
9. bronze cuivre

DIMENSIONI / DIMENSIONS / GRÖÙSEN / DIMENSIONS

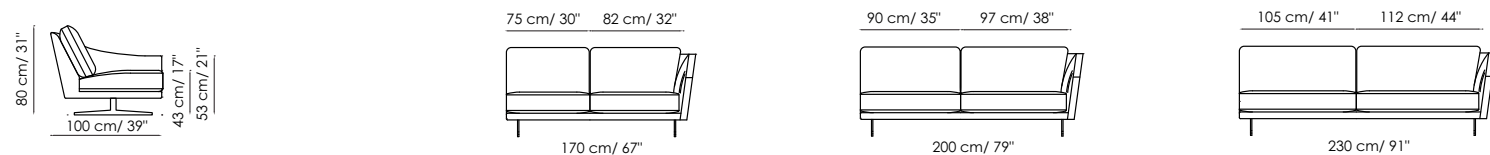

Divano angolare dx o sx / Corner sofa right or left / Ecksofa recht oder links / Canapé d'angle droite ou gauche
220 250

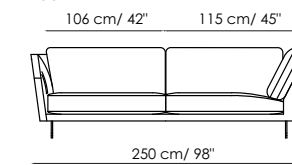

Chaise longue dx o sx / right or left / recht oder links / droite ou gauche
120x170

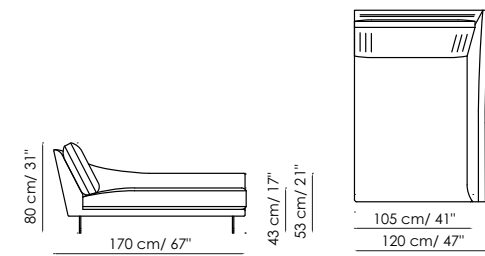

Angolo / Corner / Ecke / Angle

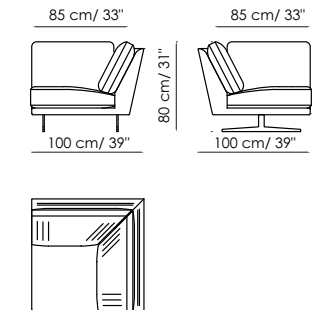

Domeuse
260

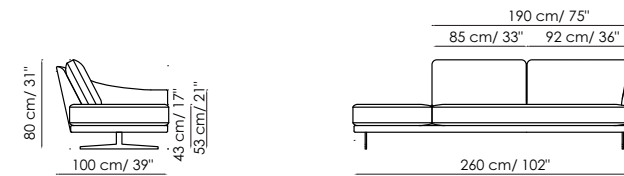

Meridiana
230

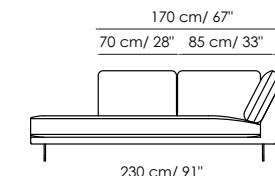

260

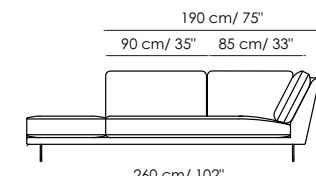

Pouf

87x87

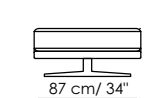

120x70

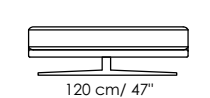

120x120

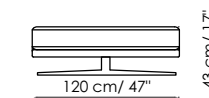

70x30

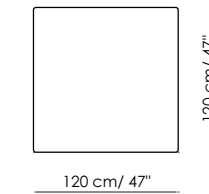
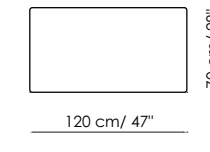
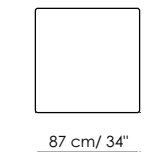
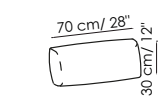

COMPOSIZIONE / COMBINATION / KOMBINATION / COMPOSITION

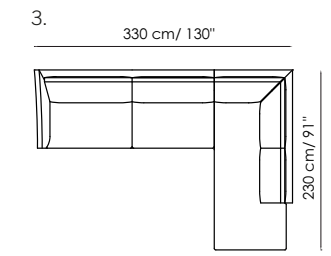
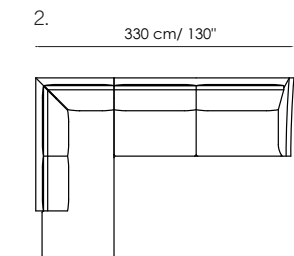
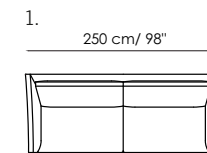

Pag. 22-23:

E62, piedi tortora / dove grey feet / Taubengrau FüÙe / pieds gris tourterelle
N°1 FKØ1 - Divano 250 / Sofa / Sofa / Canapé

Pag. 24-25:

SA50, piedi antracite / anthracite grey feet / Anthrazitgrau FüÙe / pieds gris anthracite
N°1 EKØ5 - Meridiana 230 dx / right / Recht / droit
N°1 FKØ4 - Terminale 230 dx / End section sofa right / Sofa Endteil Recht / Élément terminal droit

Pag. 26-27:

MA43, piedi antracite / anthracite grey feet / Anthrazitgrau FüÙe / pieds gris anthracite
N°1 - FKØ5, Terminale 230 sx / End section sofa left / Sofa Endteil Links / Élément terminal gauche
N°1 - EKØ6, Meridiana 230 sx / left / Links / gauche

SLAB PLUS



1 RIVESTIMENTO / COVER / BEZUG / REVÊTEMENT

RIVESTIMENTO
pelle
tessuto

UPHOLSTERY
leather
fabric

BEZUG
Leder
Stoff

REVÊTEMENT
cuir souple
tissu

2 PIEDI / FEET / FÜÙE / PIEDS

METALLO VERNICIATO OPACO



MAT PAINTED METAL

1. anthracite grey
2. dove grey
3. brown
4. amaranth
5. white
6. black

LACKIERT MATT METAL

1. Anthrazitgrau
2. Taubengrau
3. Braun
4. Amaranth
5. Weiss
6. Schwarz

METAL VERNI OPAQUE

1. gris anthracite
2. gris tourterelle
3. marron
4. amarante
5. blanc
6. noir

DIMENSIONI / DIMENSIONS / GRÖÙEN / DIMENSIONS

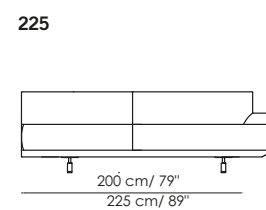
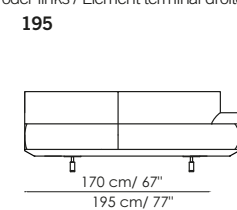
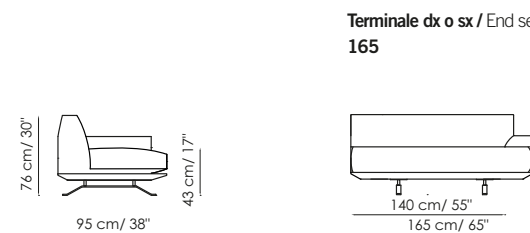
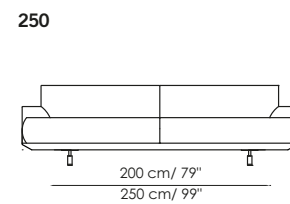
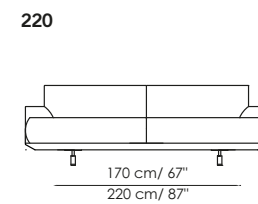
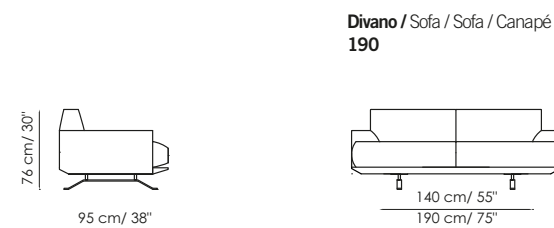

Chaise longue dx o sx / right or left / recht oder links / droite ou gauche
109x160 **124x180**

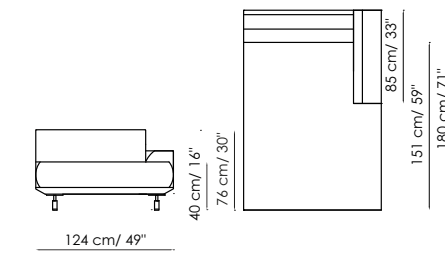
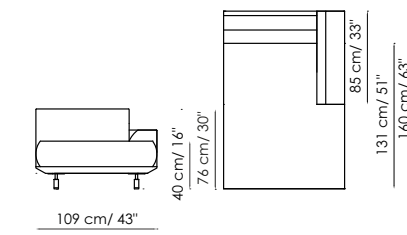

Penisola dx o sx / right or left / recht oder links / droite ou gauche
160 **180**

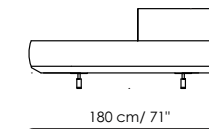
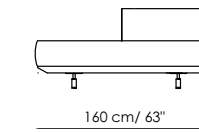
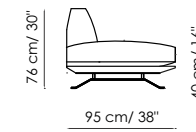

Pouf
95x60

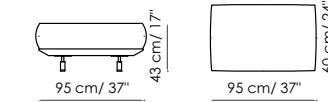

95x95

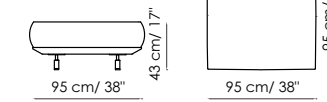

110x60

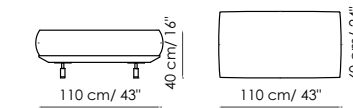

125x60

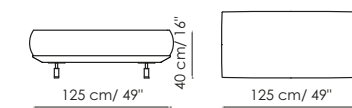

COMPOSIZIONE / COMBINATION / KOMBINATION / COMPOSITION

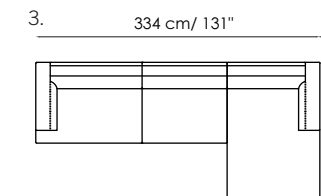
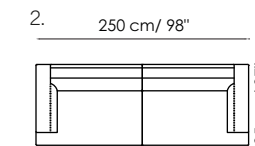
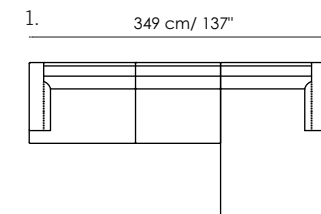

Pag. 85, 86-87, 88-89:

MB72, piedi antracite / anthracite grey feet / Anthrazitgrau FüÙe / pieds gris anthracite
N°1 FSU6 - Terminale 225 sx / End section sofa left / Sofa Endteil Links / Élément terminal gauche
N°1 EU3D - Chaise longue 124x180 dx / right / Recht / droit

Pag. 90-91:

L45, piedi tortora / dove grey feet / Taubengrau FüÙe / pieds gris tourterelle
N°1 FSP4 - Divano 250 / Sofa / Sofa / Canapé

Pag. 92-93, 95:

9A15, piedi antracite / anthracite grey feet / Anthrazitgrau FüÙe / pieds gris anthracite
N°1 FSU6 - Terminale 225 sx / End section sofa left / Sofa Endteil Links / Élément terminal gauche
N°1 EU4D - Chaise longue 109x160 dx / right / Recht / droit

STRUCTURE SOFA



1

RIVESTIMENTO / COVER / BEZUG / REVÊTEMENT

RIVESTIMENTO
pelle
tessuto

UPHOLSTERY
leather
fabric

BEZUG
Leder
Stoff

REVÊTEMENT
cuir souple
tissu

2

PIEDI / FEET / FÜÙE / PIEDS

METALLO VERNICIATO OPACO

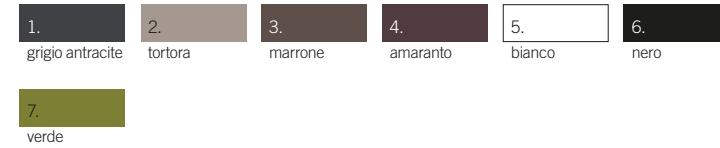

MAT PAINTED METAL

1. anthracite grey
2. dove grey
3. brown
4. amaranth
5. white
6. black
7. green

LACKIERT MATT METAL

1. Anthrazitgrau
2. Taubengrau
3. Braun
4. Amaranth
5. Weiss
6. Schwarz
7. Grün

METAL VERNI OPAQUE

1. gris anthracite
2. gris tourterelle
3. marron
4. amarante
5. blanc
6. noir
7. vert

DIMENSIONI / DIMENSIONS / GRÖÙSEN / DIMENSIONS

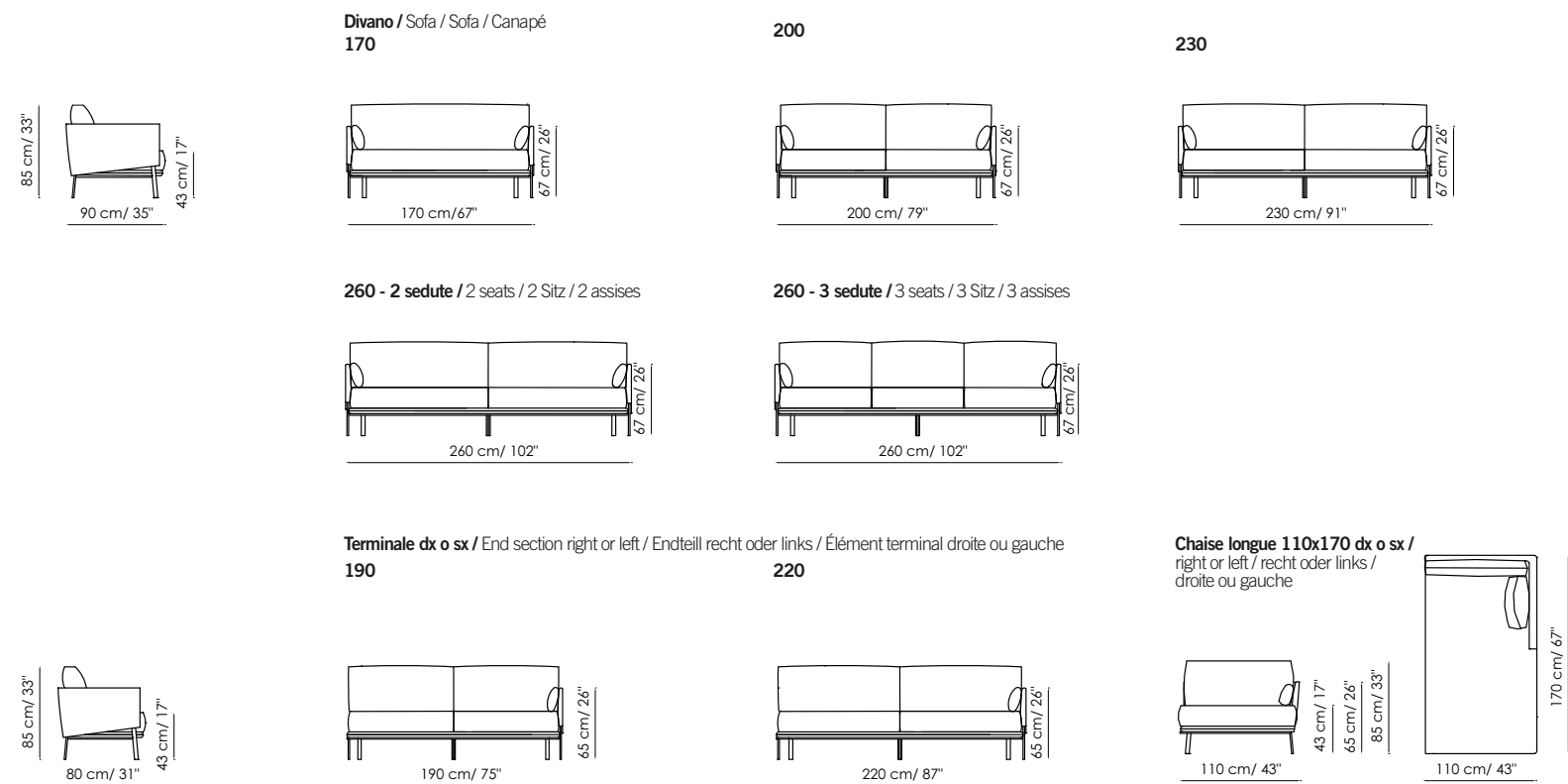

COMPOSIZIONE / COMBINATION / KOMBINATION / COMPOSITION

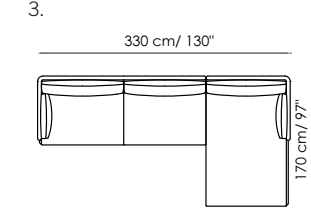
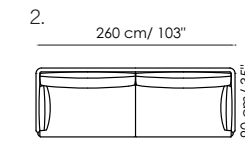
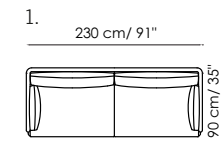

Pag. 97-98-99:

N°1 FTR4 - Divano 230 / Sofa / Sofa / Canapé - **MA06**, piedi verdi / green feet / Grün FüÙe / pieds verts

Pag. 100-101:

N°1 FTR5 - Divano 260 2 sedute / Sofa 260 2 seats / Sofa 260 2 Sitz / canapé 260 2 assises - **MA07**, piedi antracite / anthracite grey feet / Anthrazitgrau FüÙe / pieds gris anthracite

Pag. 102-103, 105:

N01, piedi tortora / dove grey feet / Taubengrau FüÙe / pieds gris tourterelle
N°1 FTRD - Terminale 220 sx / End section sofa left / Sofa Endteil Links / Élément terminal gauche
N°1 FTRA - Chaise longue 110x170 dx / right / Recht / droit

Nei disegni della sezione tecnica di questo catalogo, tutti gli elementi che offrono la possibilità di scelta destra o sinistra, per omogeneità di rappresentazione, sono illustrati nel verso destro (se non diversamente specificato).

In the drawings of the technical section of this catalog, all the elements that offer the right or left choice are shown as right (unless otherwise specified), due to homogeneity of representation.

In den Zeichnungen des technischen Abschnitt dieses Kataloges sind alle Modelle, die rechts oder links Wahlausführung anbieten, wegen Homogenität der Darstellung, mit rechte Ausrichtung dargestellt (wenn nicht anders angegeben).

Dans les dessins de la section technique de ce catalogue, tous les éléments qui offrent le choix de droite ou de gauche sont montrés dans la version droite (sauf indication contraire), pour homogénéité de représentation.

LOVY



①

RIVESTIMENTO / COVER / BEZUG / REVÊTEMENT

RIVESTIMENTO
pelle
tessuto

UPHOLSTERY
leather
fabric

BEZUG
Leder
Stoff

REVÊTEMENT
cuir souple
tissu

②

PIEDI / FEET / FÜÙE / PIEDS

METALLO VERNICIATO OPACO

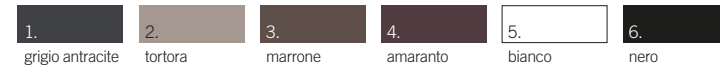

METALLO FINITURA



MAT PAINTED METAL

1. anthracite grey
2. dove grey
3. brown
4. amaranth
5. white
6. black

- METAL FINISH**
7. chrome
 8. black nickel
 9. copper bronze

LACKIERT MATT METAL

1. Anthrazitgrau
2. Taubengrau
3. Braun
4. Amaranth
5. Weiss
6. Schwarz

- METALL AUSFÜHRUNG**
7. Verchromt
 8. Schwarz vernickelt
 9. Kupferbronze

METAL VERNI OPAQUE

1. gris anthracite
2. gris tourterelle
3. marron
4. amaranth
5. blanc
6. noir

- FINITION MÉTAL**
7. chromé
 8. noir nickel
 9. bronze cuivre

DIMENSIONI / DIMENSIONS / GRÖÙEN / DIMENSIONS

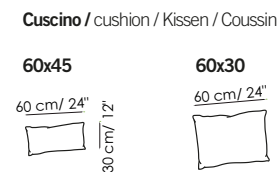
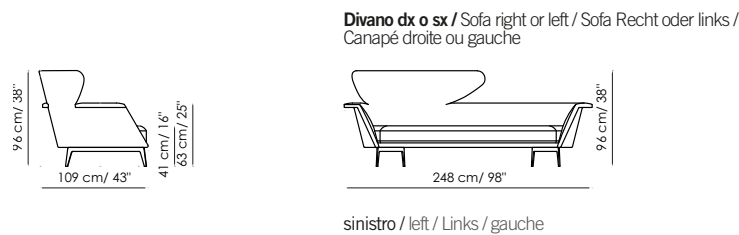

COMPOSIZIONE / COMBINATION / KOMBINATION / COMPOSITION

Pag. 187, 188, 189.
N°1 FLOV - Divano / Sofa / Sofa / Canapé - **9B17**, piedi antracite / anthracite grey feet / Anthrazitgrau FüÙe / pieds gris anthracite
N°1 CLV1 - Cuscino 60x45 / Cushion / Kissen / Coussin - **9B18**
N°1 CLV2 - Cuscino 60x30 / Cushion / Kissen / Coussin - **9B17**

Pag. 190, 191.
N°1 FLOV - Divano / Sofa / Sofa / Canapé - **MB06**, piedi marroni / brown feet / Braun FüÙe / pieds marrons
N°1 CLV1 - Cuscino 60x45 / Cushion / Kissen / Coussin - **MB06**
N°1 CLV2 - Cuscino 60x30 / Cushion / Kissen / Coussin - **MB07**

BANDY



①

RIVESTIMENTO / COVER / BEZUG / REVÊTEMENT

RIVESTIMENTO
pelle
tessuto

UPHOLSTERY
leather
fabric

BEZUG
Leder
Stoff

REVÊTEMENT
cuir souple
tissu

②

BASAMENTO / BASE / GESTELL / BASE



MAT PAINTED METAL

1. anthracite grey
2. dove grey
3. brown
4. white
5. black
6. red

LACKIERT MATT METAL

1. Anthrazitgrau
2. Taubengrau
3. Braun
4. Weiss
5. Schwarz
6. Rot

METAL VERNI OPAQUE

1. gris anthracite
2. gris tourterelle
3. marron
4. blanc
5. noir
6. rouge

DIMENSIONI / DIMENSIONS / GRÖÙEN / DIMENSIONS

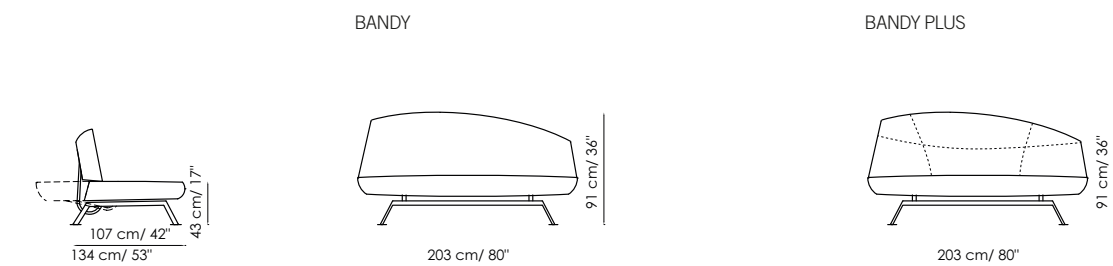

Piano letto / Sleeping surface / Liegefläche / Plan de couchage - 120x200 cm - 47"x79"

COMPOSIZIONE / COMBINATION / KOMBINATION / COMPOSITION

N°1 DBI8 Bandy plus
Pag. 195, 196, 197.
L01 - basamento rosso / red frame / Rot Gestell / base rouge
Pag. 198, 199.
92V - basamento rosso / red frame / Rot Gestell / base rouge

PAPILLON, PAPILLON XL



① RIVESTIMENTO / COVER / BEZUG / REVÊTEMENT

RIVESTIMENTO	UPHOLSTERY	BEZUG	REVÊTEMENT
pelle tessuto	leather fabric	Leder Stoff	cuir souple tissu

② PIEDI / FEET / FÜÙE / PIEDS

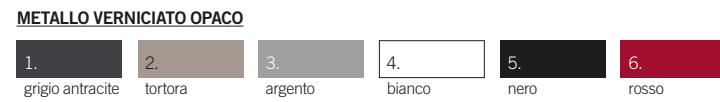

METALLO FINITURA
7. cromato

MAT PAINTED METAL	LACKIERT MATT METAL	METAL VERNI OPAQUE
1. anthracite grey 2. dove grey 3. silver 4. white 5. black 6. red	1. Anthrazitgrau 2. Taubengrau 3. Silber 4. Weiss 5. Schwarz 6. Rot	1. gris anthracite 2. gris tourterelle 3. argent 4. blanc 5. noir 6. rouge
METAL FINISH 7. chrome	METALL AUSFÜHRUNG 7. Verchromt	FINITION MÉTAL 7. chromé

DIMENSIONI / DIMENSIONS / GRÖÙEN / DIMENSIONS

PAPILLON

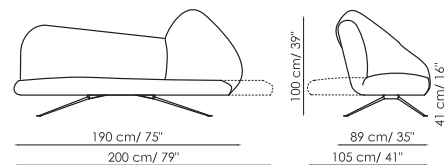

Piano letto / Sleeping surface / Liegefläche / Plan de couchage
95x195 cm - 37"x77"

PAPILLON XL

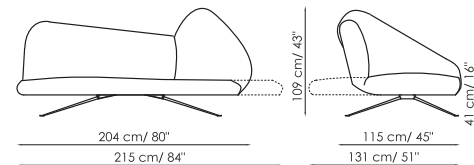

Piano letto / Sleeping surface / Liegefläche / Plan de couchage
120x200 cm - 47"x79"

COMPOSIZIONE / COMBINATION / KOMBINATION / COMPOSITION

N°1 - DPL5 Papillon XL
Pag. 202, 203:
96C - basamento argento / silver frame / Silber Gestell / base argent
Pag. 200, 201:
97H - basamento tortora / dove grey frame / Taubengrau Gestell / base gris tourterelle

PIERROT, PIERROT KING



① RIVESTIMENTO / COVER / BEZUG / REVÊTEMENT

RIVESTIMENTO	UPHOLSTERY	BEZUG	REVÊTEMENT
pelle tessuto ecopelle	leather fabric eco leather	Leder Stoff Ecoleder	cuir souple tissu éco-cuir

② PIEDI / FEET / FÜÙE / PIEDS

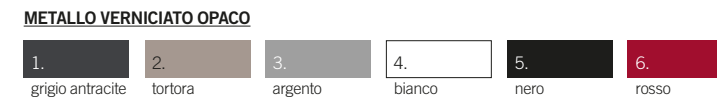

METALLO FINITURA
7. cromato

MAT PAINTED METAL	LACKIERT MATT METAL	METAL VERNI OPAQUE
1. anthracite grey 2. dove grey 3. silver 4. white 5. black 6. red	1. Anthrazitgrau 2. Taubengrau 3. Silber 4. Weiss 5. Schwarz 6. Rot	1. gris anthracite 2. gris tourterelle 3. argent 4. blanc 5. noir 6. rouge
METAL FINISH 7. chrome	METALL AUSFÜHRUNG 7. Verchromt	FINITION MÉTAL 7. chromé

DIMENSIONI / DIMENSIONS / GRÖÙEN / DIMENSIONS

PIERROT

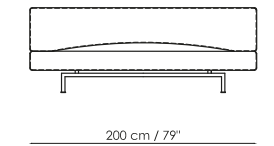
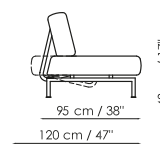

Piano letto / Sleeping surface / Liegefläche / Plan de couchage
120x200 cm - 47"x79"

PIERROT KING

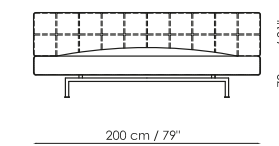

Piano letto / Sleeping surface / Liegefläche / Plan de couchage
120x200 cm - 47"x79"

COMPOSIZIONE / COMBINATION / KOMBINATION / COMPOSITION

Pag. 205, 206, 207:
N°1 - DBI4 Pierrot King - **M98**, basamento rosso / red frame / Rot Gestell / base rouge
Pag. 208:
N°1 - DBI3 Pierrot - **L01**, basamento antracite / anthracite grey frame / Anthrazitgrau Gestell / base gris anthracite
Pag. 209:
N°1 - DBI4 + SPSLØ1 Pierrot King - **L01**, basamento cromato / chromed frame / verchromt Gestell / base chromé

ALFIE, ALFIE ARM



1
RIVESTIMENTO / COVER / BEZUG / REVÊTEMENT

RIVESTIMENTO	UPHOLSTERY	BEZUG	REVÊTEMENT
pelle tessuto ecopelle	leather fabric eco leather	Leder Stoff Ecoleder	cuir souple tissu éco-cuir

2
SCOCCA / BODY / SITZFLÄCHE / COQUE

CUOIO	EMERY LEATHER	KERNLEDER	CUIR
cuoio rigenerato di fibre di cuoio	emery leather bonded leather	Kernleder Lederfaserstoff	cuir cuir reconstitué

3
BASAMENTO / BASE / GESTELL / BASE

METALLO VERNICIATO OPACO	METALLO FINITURA	MAT PAINTED METAL	LACKIERT MATT METAL	METAL VERNI OPAQUE
1. grigio antracite 2. bianco 3. rosso	4. cromato 5. black nickel	1. anthracite grey 2. white 3. red	1. Anthrazitgrau 2. Weiss 3. Rot	1. gris anthracite 2. blanc 3. rouge
		METAL FINISH	METALL AUSFÜHRUNG	FINITION MÉTAL
		4. chrome 5. black nickel	4. Verchromt 5. Schwarz vernickelt	4. chromé 5. noir nickel

DIMENSIONI / DIMENSIONS / GRÖSSEN / DIMENSIONS

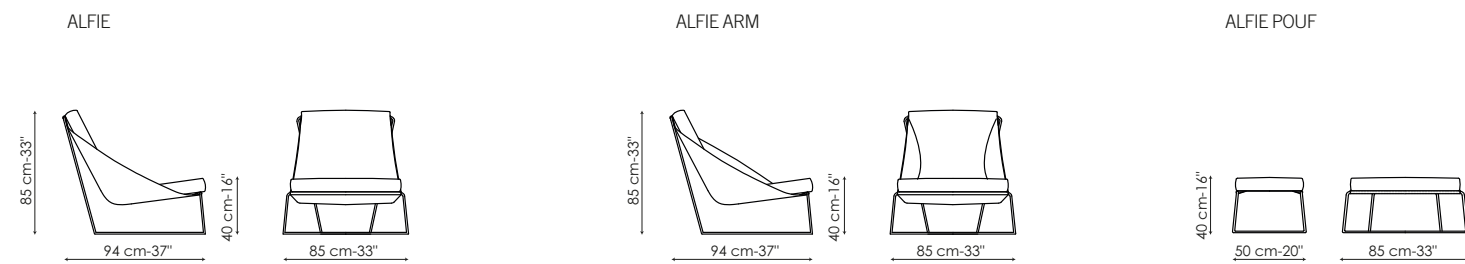

COMPOSIZIONE / COMBINATION / KOMBINATION / COMPOSITION

Pag. 240, 241:
N°1 DT36 Alfie Arm - **MB63** (rivestimento / upholstery / Bezug / revêtement) + **F14** (scocca / body / Sitzfläche / coque), **struttura grigio antracite / anthracite grey frame / Anthrazitgrau Gestell / structure gris anthracite**

Pag. 242:
N°1 DT22 Alfie - **68D** (rivestimento / upholstery / Bezug / revêtement) + **F1** (scocca / body / Sitzfläche / coque), **struttura bianca / white frame / Weiss Gestell / structure blanche**

Pag. 242:
N°1 DT22 Alfie - **SA35** (rivestimento / upholstery / Bezug / revêtement) + **F14** (scocca / body / Sitzfläche / coque), **struttura antracite / anthracite grey frame / Anthrazitgrau Gestell / structure gris anthracite**

Pag. 243:
N°1 DT22 Alfie + N°1 DU42 Alfie pouf - **9A09** (rivestimento / upholstery / Bezug / revêtement) + **F05** (scocca / body / Sitzfläche / coque), **struttura rossa / red frame / Rot Gestell / structure rouge**

ARNO



1
RIVESTIMENTO / COVER / BEZUG / REVÊTEMENT

RIVESTIMENTO	UPHOLSTERY	BEZUG	REVÊTEMENT
pelle tessuto	leather fabric	Leder Stoff	cuir souple tissu

2
PIEDI / FEET / FÜÙE / PIEDS

METALLO VERNICIATO OPACO
1. grigio antracite 2. tortora 3. marrone 4. bianco 5. nero

MAT PAINTED METAL	LACKIERT MATT METAL	METAL VERNI OPAQUE
1. anthracite grey 2. dove grey 3. brown 4. white 5. black	1. Anthrazitgrau 2. Taubengrau 3. Braun 4. Weiss 5. Schwarz	1. gris anthracite 2. gris tourterelle 3. marron 4. blanc 5. noir

DIMENSIONI / DIMENSIONS / GRÖSSEN / DIMENSIONS

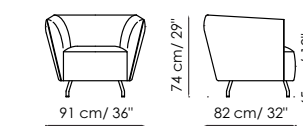

COMPOSIZIONE / COMBINATION / KOMBINATION / COMPOSITION

ARNO
N°1 PARN Arno
Pag. 217:
MB13 - base antracite / anthracite grey base / Anthrazitgrau Basis / base gris anthracite
Pag. 218-219:
MB35 - base antracite / anthracite grey base / Anthrazitgrau Basis / base gris anthracite

BLAZER, BLAZER SOFA



① **RIVESTIMENTO / COVER / BEZUG / REVÊTEMENT**

RIVESTIMENTO	UPHOLSTERY	BEZUG	REVÊTEMENT
pelle tessuto	leather fabric	Leder Stoff	cuir souple tissu

② **PIEDI / FEET / FÜÙE / PIEDS**

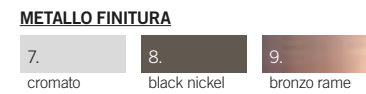
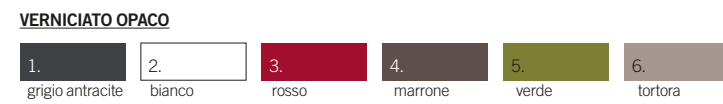

MAT PAINTED METAL	LACKIERT MATT METAL	METAL VERNI OPAQUE
1. anthracite grey	1. Anthrazitgrau	1. gris anthracite
2. white	2. Weiss	2. blanc
3. red	3. Rot	3. rouge
4. brown	4. Braun	4. marron
5. green	5. Grün	5. vert
6. dove grey	6. Taubengrau	6. gris tourterelle
METAL FINISH	METALL AUSFÜHRUNG	FINITION MÉTAL
7. chrome	7. Verchromt	7. chromé
8. black nickel	8. Schwarz vernickelt	8. noir nickel
9. copper bronze	9. Kupferbronze	9. bronze cuivre

DIMENSIONI / DIMENSIONS / GRÖÙEN / DIMENSIONS

BLAZER

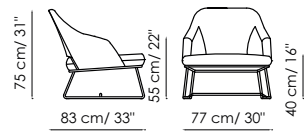

BLAZER HI

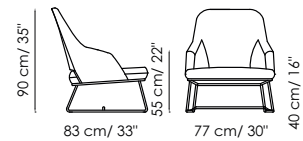

BLAZER SOFA

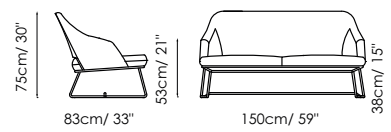

BLAZER POUF

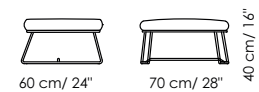

COMPOSIZIONE / COMBINATION / KOMBINATION / COMPOSITION

N°1 QBZ1 Blazer
 Pag. 229:
SA50 (base antracite / anthracite grey base / Anthrazitgrau Basis / base gris anthracite
 Pag. 230, 231:
E62 (rivestimento / cover / Bezug / revêtement) + **NO1** (retro schienale / outer backrest / Rückseite der Rückenlehne / externe du dossier), **base tortora** / dove grey base / Taubengrau Basis / base gris tourterelle

N°1 QBZ2 Blazer Sofa
 Pag. 232-233:
E53 (rivestimento / cover / Bezug / revêtement) + **A02** (retro schienale / outer backrest / Rückseite der Rückenlehne / externe du dossier), **base tortora** / dove grey base / Taubengrau Basis / base gris tourterelle

BODO



① **RIVESTIMENTO / COVER / BEZUG / REVÊTEMENT**

RIVESTIMENTO	UPHOLSTERY	BEZUG	REVÊTEMENT
pelle tessuto	leather fabric	Leder Stoff	cuir souple tissu

② **INSERTO / INSERT / EINLAGE / INSERT**

pelle Capri	Capri leather	Leder Capri	cuir souple Capri
-------------	---------------	-------------	-------------------

③ **BASE GIREVOLE O PIEDI / SWIVEL BASE OR FEET / DREHBARE BASIS ODER FÜÙE / BASE PIVOTANTE OU PIEDS**

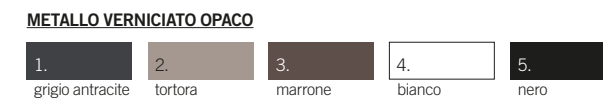

MAT PAINTED METAL	LACKIERT MATT METAL	METAL VERNI OPAQUE
1. anthracite grey	1. Anthrazitgrau	1. gris anthracite
2. dove grey	2. Taubengrau	2. gris tourterelle
3. brown	3. Braun	3. marron
4. white	4. Weiss	4. blanc
5. black	5. Schwarz	5. noir

DIMENSIONI / DIMENSIONS / GRÖÙEN / DIMENSIONS

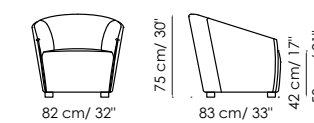
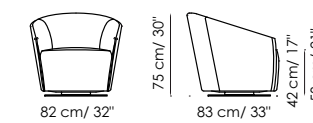

COMPOSIZIONE / COMBINATION / KOMBINATION / COMPOSITION

N°1 PBOD - Bodo con base girevole / with swivel base / mit Drehbare Basis / avec base pivotante
 Pag. 221:
MB53 (rivestimento / cover / Bezug / revêtement) + **L43** (inserto / insert / Einlage / insert)
 Pag. 222, 223:
L30 (rivestimento / cover / Bezug / revêtement) + **L04** (inserto / insert / Einlage / insert)

BRUNO



① **RIVESTIMENTO / COVER / BEZUG / REVÊTEMENT**

RIVESTIMENTO	UPHOLSTERY	BEZUG	REVÊTEMENT
pelle tessuto	leather fabric	Leder Stoff	cuir souple tissu

② **INSERTO / INSERT / EINLAGE / INSERT**

pelle Capri	Capri leather	Leder Capri	cuir souple Capri
-------------	---------------	-------------	-------------------

③ **BASE GIREVOLE O PIEDI / SWIVEL BASE OR FEET / DREHBARE BASIS ODER FÜÙE / BASE PIVOTANTE OU PIEDS**

METALLO VERNICIATO OPACO

1. grigio antracite	2. tortora	3. marrone	4. bianco	5. nero
---------------------	------------	------------	-----------	---------

MAT PAINTED METAL	LACKIERT MATT METAL	METAL VERNI OPAQUE
1. anthracite grey	1. Anthrazitgrau	1. gris anthracite
2. dove grey	2. Taubengrau	2. gris tourterelle
3. brown	3. Braun	3. marron
4. white	4. Weiss	4. blanc
5. black	5. Schwarz	5. noir

DIMENSIONI / DIMENSIONS / GRÖÙEN / DIMENSIONS

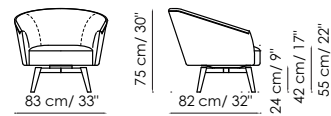

COMPOSIZIONE / COMBINATION / KOMBINATION / COMPOSITION

N°1 PBRU Bruno

Pag. 225.

MB92 (rivestimento / cover / Bezug / revêtement) + **L26** (inserto / insert / Einlage / insert), base tortora / dove grey base / Taubengrau Basis / base gris tourterelle

Pag. 226, 227.

NO2 (rivestimento / cover / Bezug / revêtement) + **L02** (inserto / insert / Einlage / insert), base antracite / anthracite grey base / Anthrazitgrau Basis / base gris anthracite

LARS, LARS PLUS



① **RIVESTIMENTO / COVER / BEZUG / REVÊTEMENT**

RIVESTIMENTO	UPHOLSTERY	BEZUG	REVÊTEMENT
pelle tessuto	leather fabric	Leder Stoff	cuir souple tissu

② **PIEDI / FEET / FÜÙE / PIEDS**
(disponibile con piedi o base a slitta) / (available with feet or sliding base) / (mit FüÙe oder mit Kufenbasis erhältlich) / (disponible avec pieds ou coulisse)

METALLO VERNICIATO OPACO

1. grigio antracite	2. tortora	3. marrone	4. amaranto	5. bianco	6. nero
---------------------	------------	------------	-------------	-----------	---------

MAT PAINTED METAL	LACKIERT MATT METAL	METAL VERNI OPAQUE
1. anthracite grey	1. Anthrazitgrau	1. gris anthracite
2. dove grey	2. Taubengrau	2. gris tourterelle
3. brown	3. Braun	3. marron
4. amaranth	4. Amaranth	4. amarante
5. white	5. Weiss	5. blanc
6. black	6. Schwarz	6. noir

DIMENSIONI / DIMENSIONS / GRÖÙEN / DIMENSIONS

LARS schienale basso / low backrest / niedrige rückenlehne / dossier bas

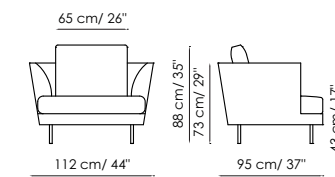

LARS schienale alto / high backrest / höhere rückenlehne / dossier haut

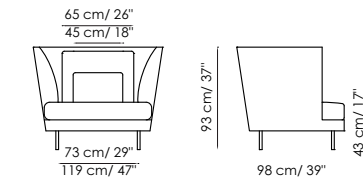

LARS PLUS schienale basso / low backrest / niedrige rückenlehne / dossier bas

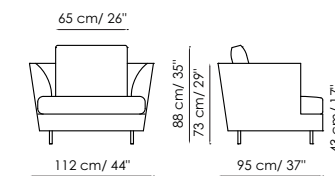

LARS PLUS schienale alto / high backrest / höhere rückenlehne / dossier haut

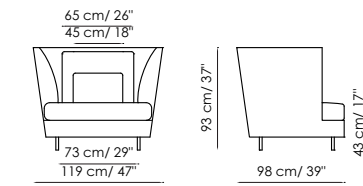

COMPOSIZIONE / COMBINATION / KOMBINATION / COMPOSITION

Pag. 49-249.

N°1 QLB1 Poltrona schienale basso / low backrest / niedrige Rückenlehne / dossier bas - **MB86**, piedi antracite / anthracite grey feet / Anthrazitgrau FüÙe / pieds gris anthracite

LOCK



1

RIVESTIMENTO / COVER / BEZUG / REVÊTEMENT

RIVESTIMENTO INTERNO

ecopelle
tessuto
pelle

RIVESTIMENTO RETRO SCHIENALE

pelle
tessuto

INSIDE UPHOLSTERY

eco leather
fabric
leather

BACK UPHOLSTERY

leather
fabric

INNEN BEZUG

Kunstleder
Stoff
Leder

RÜCHSEITE BEZUG

Stoff
Leder

REVÊTEMENT INTÉRIEUR

éco-cuir
tissu
cuir souple

REVÊTEMENT ARRIÈRE

tissu
cuir souple

2

BASE / BASE / BASIS / BASE

METALLO VERNICIATO OPACO

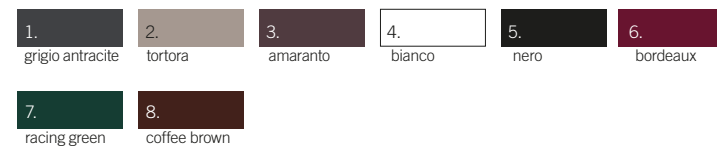

METALLO FINITURA

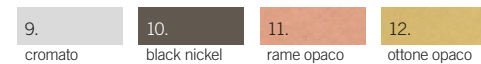

MAT PAINTED METAL

1. anthracite grey
2. dove grey
3. amaranth
4. white
5. black
6. bordeaux
7. racing green
8. coffee brown

METAL FINISH

9. chrome
10. black nickel
11. mat copper
12. mat brass

LACKIERT MATT METAL

1. Anthrazitgrau
2. Taubengrau
3. Amaranth
4. Weiss
5. Schwarz
6. Bordeaux
7. Racing green
8. Coffee brown

METALL AUSFÜHRUNG

9. Verchromt
10. Schwarz vernickelt
11. Kupfer matt
12. Messing matt

METAL VERNI OPAQUE

1. gris anthracite
2. gris tourterelle
3. amaranthe
4. blanc
5. noir
6. bordeaux
7. racing green
8. coffee brown

FINITION MÉTAL

9. chromé
10. noir nickel
11. cuivre opaque
12. laiton opaque

DIMENSIONI / DIMENSIONS / GRÖSSEN / DIMENSIONS

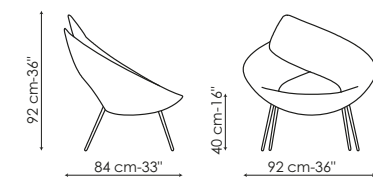

COMPOSIZIONE / COMBINATION / KOMBINATION / COMPOSITION

Pag. 212-213:

MB91 - base racing green / racing green base / racing green Basis / base racing green
N°1 DV05 Lock

Pag. 214-215:

MB15 (Interno / inside / Innen / intérieur) + **96L** (retro schienale / back / Rückseite / arrière) -
base antracite / anthracite grey base / Anthrazitgrau Basis / base gris anthracite
N°1 DV05 + SPLOCK1 Lock

NIKOS EGO, NIKOS LOW, NIKOS SOFA



1

RIVESTIMENTO SEDUTA / COVER SEAT / BEZUG SITZFLÄCHE / REVÊTEMENT SIÈGE

RIVESTIMENTO

pelle
tessuto

UPHOLSTERY

leather
fabric

BEZUG

Leder
Stoff

REVÊTEMENT

cuir souple
tissu

2

PIEDI / FEET / FÜÙE / PIEDS

METALLO VERNICIATO OPACO



METALLO FINITURA



MAT PAINTED METAL

1. anthracite grey
2. dove grey
3. brown
4. red
5. white
6. green

METAL FINISH

7. chrome
8. black nickel
9. copper bronze

LACKIERT MATT METAL

1. Anthrazitgrau
2. Taubengrau
3. Braun
4. Rot
5. Weiss
6. Grün

METALL AUSFÜHRUNG

7. Verchromt
8. Schwarz vernickelt
9. Kupferbronze

METAL VERNI OPAQUE

1. gris anthracite
2. gris tourterelle
3. marron
4. rouge
5. blanc
6. vert

FINITION MÉTAL

7. chromé
8. noir nickel
9. bronze cuivre

DIMENSIONI / DIMENSIONS / GRÖSSEN / DIMENSIONS

NIKOS LOW

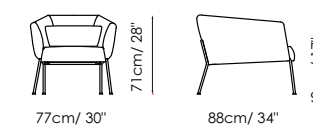

NIKOS EGO

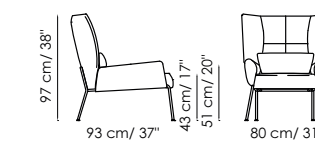

NIKOS SOFA

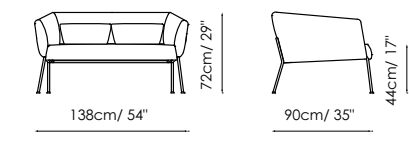

NIKOS POUF

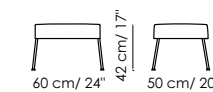

COMPOSIZIONE / COMBINATION / KOMBINATION / COMPOSITION

N°1 QN18 Nikos ego

Pag. 234, 237:

SA36 - base tortora / dove grey base / Taubengrau Basis / base gris tourterelle

Pag. 236:

MA80 - base antracite / anthracite grey base / Anthrazitgrau Basis / base gris anthracite

Pag. 235:

QN13 Nikos low

96P - base tortora / dove grey base / Taubengrau Basis / base gris tourterelle

M85 - base tortora / dove grey base / Taubengrau Basis / base gris tourterelle

Pag. 238-239:

N°1 QN17 Nikos Sofa

M85 - base tortora / dove grey base / Taubengrau Basis / base gris tourterelle

PARAISO



①

RIVESTIMENTO / COVER / BEZUG / REVÊTEMENT

RIVESTIMENTO
pelle
tessuto

UPHOLSTERY
leather
fabric

BEZUG
Leder
Stoff

REVÊTEMENT
cuir souple
tissu

②

PIEDI / FEET / FÜÙE / PIEDS

METALLO VERNICIATO OPACO



LEGNO

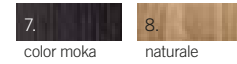

RIVESTITI IN PELLE CAPRI

MAT PAINTED METAL

1. anthracite grey
2. dove grey
3. brown
4. amaranth
5. white
6. black

WOOD

7. dark brown
8. natural

LEATHER CAPRI COVERED

LACKIERT MATT METAL

1. Anthrazitgrau
2. Taubengrau
3. Braun
4. Amaranth
5. Weiss
6. Schwarz

HOLZ

7. Dunkelbraunfarbig
8. Naturfarbig

AUS LEDER CAPRI BEZOGEN

METAL VERNI OPAQUE

1. gris anthracite
2. gris tourterelle
3. marron
4. amarante
5. blanc
6. noir

BOIS

7. marron foncé
8. naturel

REVÊTUS EN CUIR SOUPLE CAPRI

DIMENSIONI / DIMENSIONS / GRÖÙSEN / DIMENSIONS

PARAISO schienale basso / low backrest / niedrige rückenlehne / dossier bas

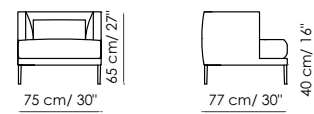

Pouf

75x50



85x50

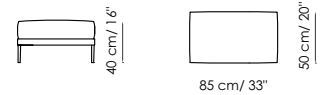

PARAISO schienale alto / high backrest / höhere rückenlehne / dossier haut

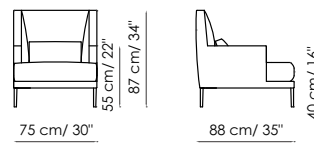

85x85

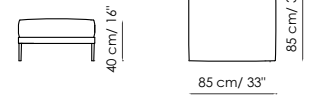

100x100

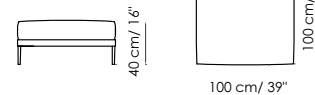

COMPOSIZIONE / COMBINATION / KOMBINATION / COMPOSITION

Pag. 118, 119, 251, 252, 253:

N°1 QR11 - Poltrona schienale basso / low backrest armchair / niedrige Rückenlehne Sessel / Fauteuil dossier bas - **EA63**, piedi tortora / dove grey feet / Taubengrau FüÙe / pieds gris tourterelle

Pag. 254, 255

96A

N°1 QPZ2 - Poltrona schienale alto con balza / high backrest armchair with frill / niedrige Rückenlehne Sessel mit Rüschen / Fauteuil dossier haut avec volant

Pag. 257

M92

N°1 QPZ2 - Poltrona schienale alto con balza / high backrest armchair with frill / niedrige Rückenlehne Sessel mit Rüschen / Fauteuil dossier haut avec volant

N°1 ORZ1 - Pouf 75x50 con balza / with frill / mit Rüschen / avec volant

STRUCTURE ARMCHAIR



①

RIVESTIMENTO / COVER / BEZUG / REVÊTEMENT

RIVESTIMENTO
pelle
tessuto

UPHOLSTERY
leather
fabric

BEZUG
Leder
Stoff

REVÊTEMENT
cuir souple
tissu

②

PIEDI / FEET / FÜÙE / PIEDS

METALLO VERNICIATO OPACO



7.

verde

MAT PAINTED METAL

1. anthracite grey
2. dove grey
3. brown
4. amaranth
5. white
6. black
7. green

LACKIERT MATT METAL

1. Anthrazitgrau
2. Taubengrau
3. Braun
4. Amaranth
5. Weiss
6. Schwarz
7. Grün

METAL VERNI OPAQUE

1. gris anthracite
2. gris tourterelle
3. marron
4. amarante
5. blanc
6. noir
7. vert

DIMENSIONI / DIMENSIONS / GRÖÙSEN / DIMENSIONS

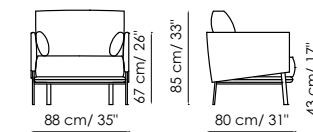

COMPOSIZIONE / COMBINATION / KOMBINATION / COMPOSITION

Pag. 246:

N°1 QN15 - Poltrona / armchair / Sessel / Fauteuil - **96P**, piedi antracite / anthracite grey feet / Anthrazitgrau FüÙe / pieds gris anthracite

Pag. 245, 247:

N°1 QN15 - Poltrona / armchair / Sessel / Fauteuil - **96W**, piedi antracite / anthracite grey feet / Anthrazitgrau FüÙe / pieds gris anthracite

Pag. 102, 104:

N°1 QN15 - Poltrona / armchair / Sessel / Fauteuil - **96J**, piedi tortora / dove grey feet / Taubengrau FüÙe / pieds gris tourterelle

KERNEL



①

RIVESTIMENTO / COVER / BEZUG / REVÊTEMENT

pelle leather Leder cuir souple
tessuto fabric Stoff tissu

DIMENSIONI / DIMENSIONS / GRÖSSEN / DIMENSIONS

KERNEL 60x60

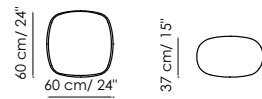

KERNEL 50x70



KERNEL 80x80

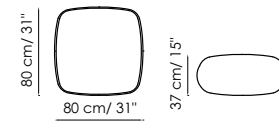

COMPOSIZIONE / COMBINATION / KOMBINATION / COMPOSITION

Pag. 263:
N°1 OPK2 - Kernel 80x80 - **MA23**
Pag. 262, 263:
N°1 OPK1 - Kernel 70x50 - **8D61**
Pag. 263:
N°1 OPK3 - Kernel 60x60 - **B13**
Pag. 262, 263:
N°1 OPK3 - Kernel 60x60 - **N04**

SECRET



①

RIVESTIMENTO / COVER / BEZUG / REVÊTEMENT

pelle leather Leder cuir souple
tessuto fabric Stoff tissu

DIMENSIONI / DIMENSIONS / GRÖSSEN / DIMENSIONS

SECRET SMALL

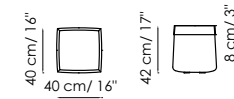

SECRET MEDIUM

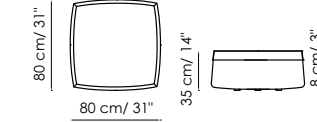

SECRET LARGE

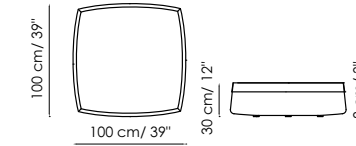

COMPOSIZIONE / COMBINATION / KOMBINATION / COMPOSITION

Pag. 260-261:
Secret medium
N°1 WPS3 - base / base / Basis / base - **MA33**
N°1 COP3 - coperchio / cover / Deckel / couvercle - **MA51**

Secret small
N°1 WPS1 - base / base / Basis / base - **N01**
N°1 COP1 - coperchio / cover / Deckel / couvercle - **9B17**

concept
romanoassociati.com

photographer
Beppe Brancato
Paolo Golumelli
Max Rommel

styling
Laura Cazzaniga
Ilaria Limonta
Studio Salaris

press
O.G.M. SpA

Printed in Italy
December 2017

Thanks to
Almerich
Amini
Bloomingtonville
Cc tapis
Edizioni design
FontanaArte
Fromental
Gong
Lanificio leo
Loloey
London art
Martinelli Luce
Marsset
Mohebban
Niki jones
Nodus
Pallucco
Pierre frey
Stilnovo
Venicem

We are social



Bonaldo SpA si riserva di modificare, senza preavviso, materiali, rivestimenti, finiture e disegni dei prodotti presentati in questo catalogo.

I colori e le finiture visualizzate sono puramente indicativi e possono differire dagli originali. Le immagini riprodotte nel presente catalogo sono di proprietà esclusiva di Bonaldo SpA.
È vietata qualunque riproduzione o utilizzo delle immagini senza preventiva autorizzazione scritta di Bonaldo SpA.

Bonaldo SpA reserves the right to change, without any notice, materials, covers, finishes and drawings of the products presented in this catalogue.
Colors and finishes shown are approximate and may differ from actual ones. All images in this catalogue are exclusive property of Bonaldo SpA.
Every reproduction or use of the images without prior written authorization from Bonaldo SpA is therefore strictly forbidden.

Bonaldo SpA behält sich das Recht vor, ohne vorherige Ankuendigung, Materialien, Ersatzbezeuge, Ausfuehrungen und Zeichnungen der in diesem Katalog vorgestellten Produkte zu aendern.
Die dargestellten Farben und Ausfuehrungen sind ungefaehre Angaben und koennen von den Originalen abweichen.
Die in diesem Katalog abgebildete Bilder sind ausschliesslich Eigentum von Bonaldo SpA.
Ohne die vorherige schriftliche Genehmigung von Bonaldo SpA. ist es jede Vervielfaeltigung oder Verwendung von Bildern verboten.

Bonaldo SpA se réserve le droit de modifier, sans préavis, les matériaux, les revêtements, les finitions et les dessins des produits présentés dans ce catalogue.
Les couleurs et les finitions indiquées sont indicatives et peuvent différer des originaux. Les images reproduites dans ce catalogue sont propriété exclusive de Bonaldo SpA.
Il est interdit la reproduction ou utilisation d'images sans l'autorisation écrite préalable de Bonaldo SpA.

BONALDO

Bonaldo SpA _ via Straelle, 3 35010 Villanova di Camposampiero (PD) Italy tel + 39 049.9299.011 bonaldo@bonaldo.it www.bonaldo.it